

ergorapido®

2in1

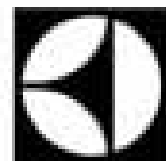

Thinking of you
Electrolux

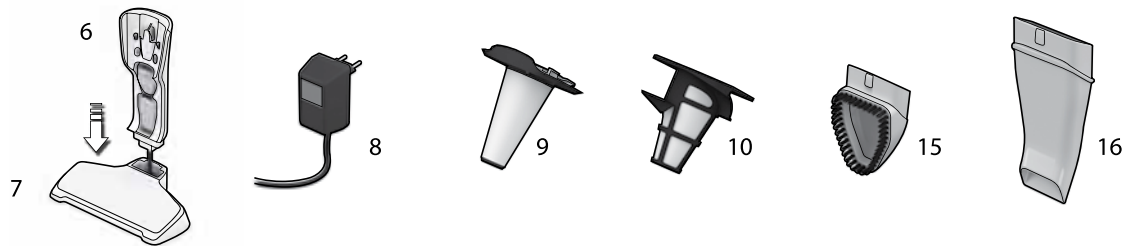
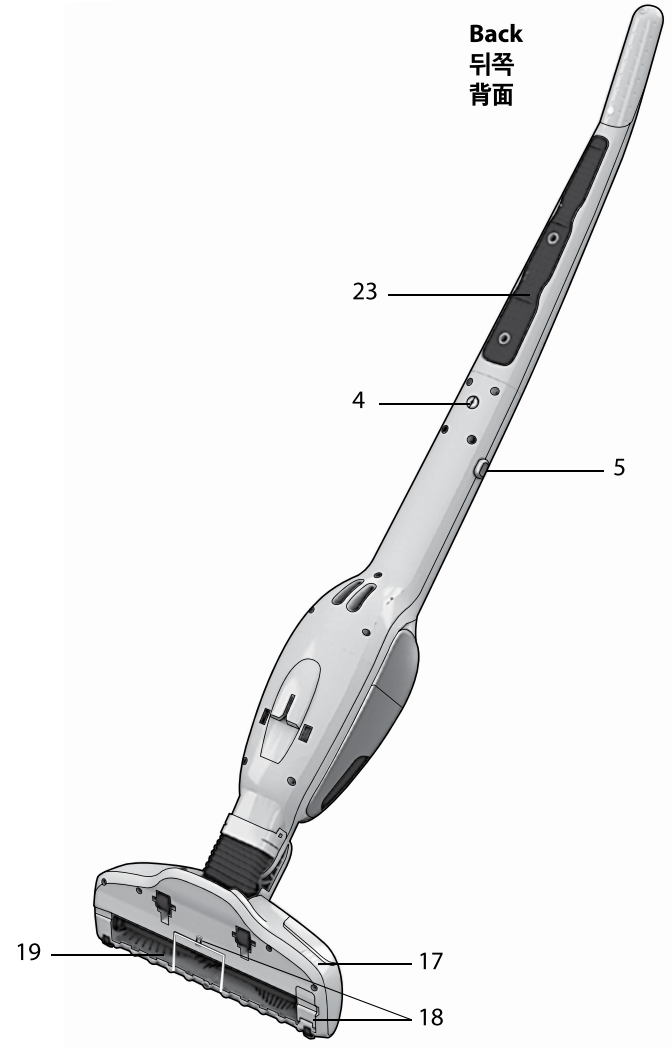
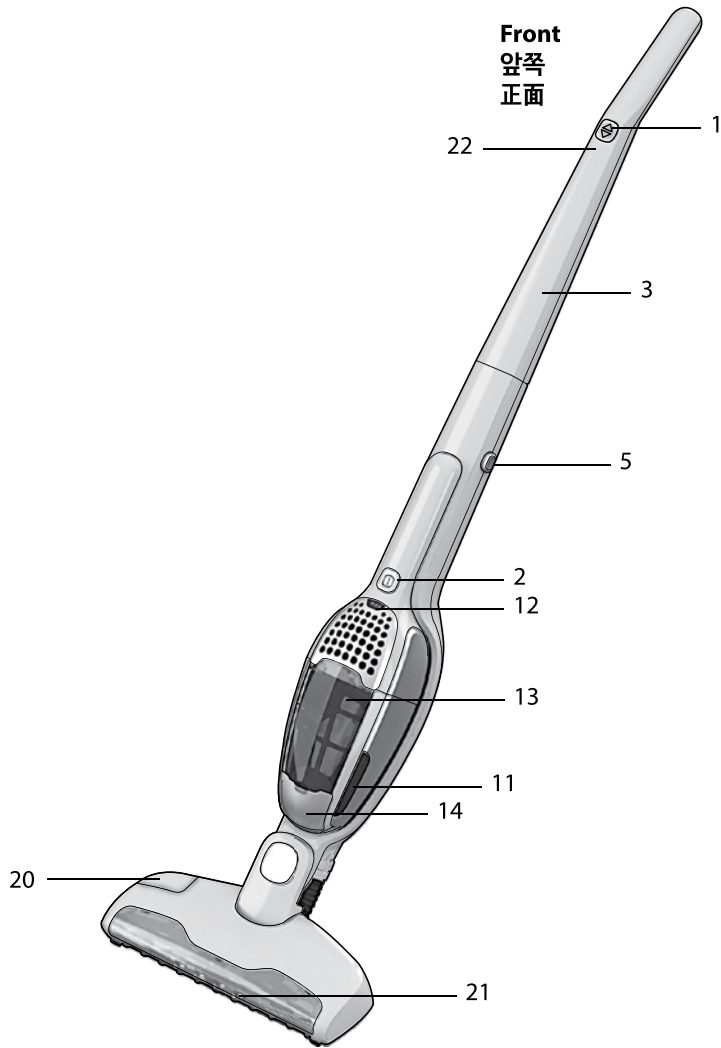

English

Table of contents

Unpacking and assembly.....	4
Charging	5
Vacuuming	6
Emptying and cleaning.....	7
Cleaning brush roll, hose and wheels	8
Removing the batteries	11
Safety precautions	12
Consumer information	13

Features/Accessories

1 On/off button
2 On/off button, hand unit
3 Handle
4 Locking screw
5 Release button, hand unit
6 Charging station, wall unit
7 Charging station, floor unit
8 Adaptor
9 Fine filter (inner filter)
10 Pre filter (outer filter)
11 Release button, dust container
12 Battery display, Lithium version*
13 Dust container
14 Vacuum cleaner lid
15 Brush
16 Crevice nozzle
17 Brush roll release button*
18 Hatch cover for brush roll*
19 Brush roll
20 BRUSHROLLCLEAN™ button*
21 Nozzle front lights
22 Charging indicator, NiMH version*
23 Parking strip

한국어

목차

포장 풀기 및 조립	4
충전하기	5
진공 청소하기	6
비우기 및 청소하기	7
브러쉬롤, 호스 및 바퀴 청소	8
배터리 제거	11
안전 주의사항	12
소비자 정보	13

특징/부속품

1 전원 버튼
2 전원 버튼, 휴대 장치
3 손잡이
4 잠금 나사
5 해제 버튼, 휴대 장치
6 충전 스테이션, 벽체 장치
7 충전 스테이션, 바닥 장치
8 어댑터
9 미세 필터(내부 필터)
10 예비 필터(외부 필터)
11 해제 버튼, 먼지통
12 배터리 용량 표시등, 리튬 제품에 한함*
13 먼지통
14 진공 청소기 뚜껑
15 브러쉬
16 틈새 노즐
17 브러쉬롤 해제 버튼*
18 브러쉬롤 해치 커버*
19 브러쉬롤
20 BRUSHROLLCLEAN™ 버튼*
21 노즐 전면등
22 충전표시등, NiMH 제품에 한함*
23 보관 스트립

* 특정 모델에만 해당

简体中文

目录

拆除包装及组装.....	4
充电	5
吸尘	6
清空及清洁	7
清洁刷辊、软管和滚轮	8
取出电池	11
安全预防措施	12
用户须知	13

功能/配件

1 电源开关
2 电源开关, 手持组件
3 手柄
4 锁紧螺丝
5 释放按钮, 手持组件
6 充电站, 墙壁组件
7 充电站, 地面组件
8 适配器
9 细滤器 (内滤器)
10 预滤器 (外滤器)
11 释放按钮, 集尘盒
12 电量显示, 锂电池版*
13 集尘盒
14 真空吸尘器盖
15 刷头
16 缝隙吸嘴
17 刷辊释放按钮*
18 刷辊盖
19 刷辊
20 BRUSHROLLCLEAN™ 按钮*
21 吸头正面指示灯
22 充电指示灯, 镍镉电池版*
23 防滑条

* 仅限特定型号

* Certain models only

GB

KOR

CHS

CHT

THA

IND

VIE

Unpacking and assembly / 포장 풀기 및 조립 / 拆除包装及组装

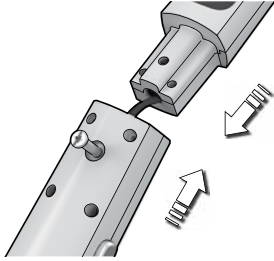

1. Check that all parts are in the box. Fit the handle by carefully inserting it into the lower main body. Make sure that the cable does not jam.

1. 모든 부품이 상자 안에 있는지 확인합니다. 손잡이를 주의하여 아래쪽 본체에 삽입하며 고정시킵니다. 케이블이 걸리지 않도록 합니다.

1. 检查包装盒中的所有部件是否齐全。 将手柄小心地插入吸尘器的下部主体。确保线缆没有纠缠或阻塞。

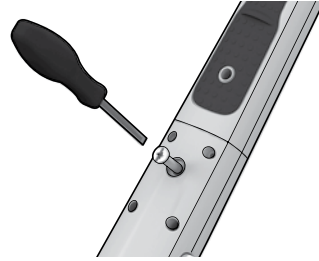

2. Secure the handle by tightening the locking screw supplied. Use a screwdriver or a coin.

2. 제공된 잠금 나사를 조이면서 손잡이를 고정시킵니다. 드라이버 또는 동전을 사용합니다.

2. 拧紧随附的锁紧螺丝固定手柄。 可以使用螺丝刀或硬币。

Charging station / 충전 스테이션 / 充电站

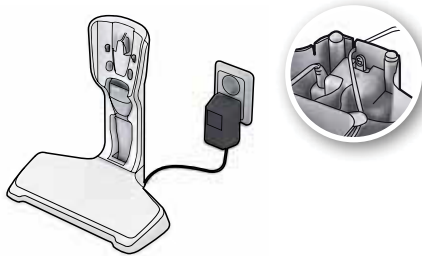

1. Position the charging station well away from heat sources, direct sunlight or wet places. Insert the adaptor into the mains and connect it to the charging station.

1. 충전 스테이션은 열원, 직사광선 및 습기가 있는 벽체에서 멀리 두십시오. 어댑터를 본체에 삽입한 후 충전 스테이션에 연결합니다.

1. 将充电站放置在远离热源、阳光直射或潮湿的地方。 将适配器插入电源并连接至充电站。

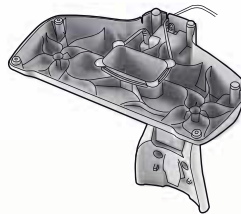

2. On the bottom of the charging station there is a hollow space where unused cable can be wound.

2. 충전 스테이션 아래쪽에는 사용하지 않는 케이블을 감아 저장할 수 있는 움푹한 공간이 있습니다.

2. 充电站底部有一处中空空间可以收藏多余的线缆。

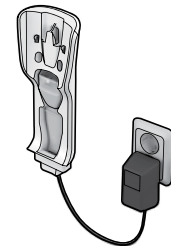

3. The wall unit can also be mounted on a wall. Separate it from the floor unit. Always ensure that the wall can withstand the weight of Ergorapido.

3. 벽체 장치는 벽에도 부착이 가능합니다. 바닥 장치에서 분리합니다. Ergorapido의 무게를 견딜 수 있는 벽체인지 확인합니다.

3. 墙壁组件也可以安装在墙壁上。 将其与地面组件分开放置。要始终确保墙壁能够承受Ergorapido的重量。

Charging / 충전하기 / 充电

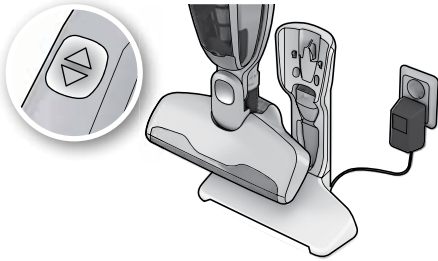

1. Ergorapido: The indicator light will come on once the Ergorapido is positioned correctly in the charging station. When fully charged, the LED will be on for a few seconds per minute.

1. Ergorapido: Ergorapido가 충전 스테이션에 정확하게 놓여지면 충전표시등은 한꺼번에 켜집니다. 안전하게 제품이 충전된 경우, 충전표시등의 LED는 1분당 몇 초간 켜지게 됩니다 (NiMH 제품에 한함)

1. Ergorapido: 将吸尘器正确安放在充电站上之后, 指示灯将点亮一次。充满电后, LED. 指示灯每分钟将亮起几秒钟。

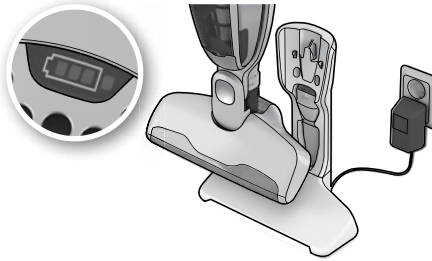

2. Ergorapido Plus: The battery capacity display lights will come on one after another as the machine is charging after being positioned correctly in the charging station.

2. Ergorapido Plus: 제품을 충전 스테이션에 정확하게 놓고 충전을 시작하면 배터리 용량 표시등이 하나씩 켜지기 시작합니다. (리튬 제품에 한함)

2. Ergorapido 增强版: .将吸尘器正确安放在充电站上后进行充电时, 电池电量显示指示灯将逐个亮起。

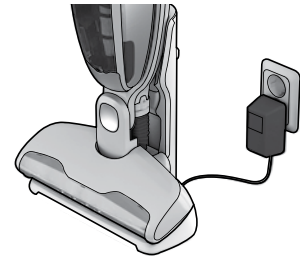

3. When fully discharged, approximately 16 hours' charging is required to regain full battery capacity (4 hours for Ergorapido Plus). Leave Ergorapido on charge when not used to maintain battery performance.

3. 완전히 방전된 경우, 배터리 용량을 완전히 채우려면 약 16시간 정도 충전해야 합니다 (Ergorapido Plus의 경우 4시간 소요). 배터리 성능을 최적으로 유지하려면 Ergorapido를 미사용시 항상 충전하십시오.

3. 电池电量耗尽时, 完全充电大约需要. 16. 小时 (Ergorapido. 增强版大约需要. 4. 小时)。为保持电池续航性能, 不使用时请保持. Ergorapido. 处于充电状态。

Battery capacity display* / 배터리 용량 표시부* / 电池电量显示*



1. 3 blue lights: battery capacity >75%
2 blue lights: battery capacity 75-25%
1 blue light: battery capacity <25%
1 blue blinking light: battery capacity - empty

1. 청색등 3개: 배터리 용량 75% 이상
청색등 2개: 배터리 용량 75-25%
청색등 1개: 배터리 용량 25% 미만
청색등 1개가 깜빡이는 경우: 배터리 용량 - 없음

1. 3. 只蓝色指示灯: 电池电量 >75%
. 2. 只蓝色指示灯: 电池电量. 75-25%
. 1. 只蓝色指示灯: 电池电量. <25%
. 1. 只蓝色指示灯闪烁: 电池电量. - 耗尽



2. If a red light is lit: Unit is too hot. Clean filters, brush roll, hose and put on charge.
3. If a red light is blinking: Motor is overloaded. Clean brush roll.

2. 적색등이 켜지는 경우: 장치가 과열되어 있습니다. 필터, 브러쉬 롤 및 호스를 청소한 후 충전하십시오.
3. 적색등이 깜빡이는 경우: 모터가 과부하 상태입니다. 브러쉬 물을 청소합니다.

2. 如果红色指示灯亮起: 吸尘器组件过热。请清洁过滤器、刷辊和软管, 然后进行充电。
3. 如果红色指示灯闪烁: .电机超过负荷。请清洁刷辊。



4. When fully charged: LED's will turn off and go into standby mode = much lower power consumption, indicated with one blink per minute.
5. If red and blue light are blinking: please refer to page 9.

4. 완전히 충전된 경우: LED가 꺼진 후 대기 모드로 전환됩니다. 이때 전원 소모는 매우 낮은 상태이며 1분당 불이 한 번 깜빡입니다.
5. 청색등과 적색등이 깜빡이는 경우: 9페이지를 참조하십시오.

4. 充电完成时: LED. 灯将熄灭, 吸尘器进入待机模式. = 此时耗电量极低, 指示灯每分钟闪烁一次。
5. 如果红色和蓝色指示灯同时闪烁: 请参见第. 9. 页。

Vacuuming floors and carpets / 바닥과 카펫 진공 청소하기 / 对地板和地毯进行吸尘清洁

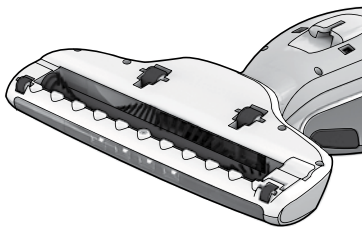

1. **You should regularly check** that the nozzle wheels and the brush roll are clean in order to avoid scratching sensitive floors.

1. 노즐 바퀴와 브러쉬 롤이 깨끗한지 정기적으로 확인하여 민감한 바닥의 긁힘을 방지하십시오.

1. 您应该定期检查确保吸头滚轮和刷辊清洁，以避免刮坏易受损的地板。

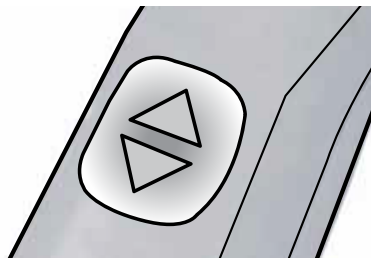

2. Start Ergorapido by pushing the on/off button.

2. 전원 버튼을 눌러 Ergorapido를 시작합니다.

2. 按下电源开关启动Ergorapido.

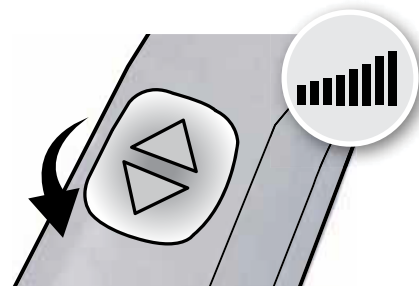

3. Adjust the power level by pushing the lower part of the on/off button.

3. 전원 아래쪽 버튼을 누르면서 출력 수준을 조정합니다.

3. 触按开关按钮下半部调节功率大小。

Vacuuming furniture, car seats etc. / 가구 및 자동차 시트 등을 진공 청소하기 / 对家具、汽车坐垫等进行吸尘清洁

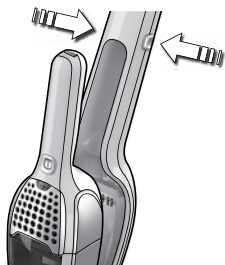

1. **Remove the hand unit by pressing the release buttons.** The crevice nozzle and small brush are stored in the charging station.

1. 해제 버튼을 누르면서 휴대 장치를 제거합니다. 충전 스테이션에 틈새 노즐 및 작은 브러쉬가 보관되어 있습니다.

1. 按下释放按钮取下吸尘器的手持组件。缝隙吸嘴和小刷头存放在充电站中。

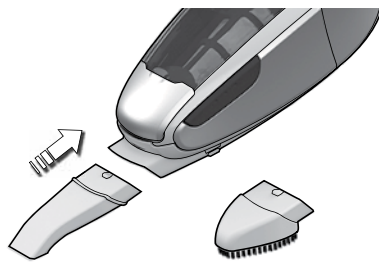

2. **Attach the crevice nozzle** to facilitate cleaning of areas difficult to reach, or attach the brush for dusting.

2. 틈새 노즐을 부착하여 접근하기 힘든 영역을 청소하거나 브러쉬를 부착하여 먼지를 제거합니다.

2. 安装缝隙吸嘴可以清洁难以抵达的卫生死角，安装小刷头可以清扫灰尘。



3. Start/stop the hand unit by pushing the start button.

3. 시작 버튼을 눌러 휴대용 장치를 시작하거나 정지합니다.

3. 按下开关可以启动/停止手持组件。

Emptying and cleaning

Ergorapido's dust container must be emptied regularly and the dust container and the filters need to be cleaned to maintain a high suction power.

Never wash dust containers or filters in a dishwasher.

비우기 및 청소하기

Ergorapido의 먼지통은 반드시 정기적으로 비우고 먼지통과 필터를 청소해야 높은 흡입력을 유지할 수 있습니다.

식기세척기에서 먼지통이나 필터를 세척하지 마십시오.

清空及清洁

Ergorapido의 集尘盒必须定期清空，并且集尘盒与过滤器都需要进行清洁，以保持较高的抽吸功率。

切勿使用洗碗机清洗集尘盒或过滤器。

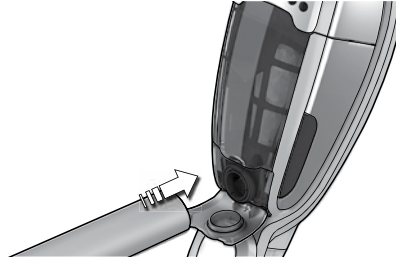

1. Quick emptying of the dust container. Open the vacuum cleaner lid. Clean the dust container by placing the hose of another vacuum cleaner at the opening.

1. 먼지통 신속하게 비우기. 진공 청소기 뚜껑을 엽니다. 다른 진공 청소기의 호스를 삽입하여 먼지통을 청소합니다.

1. 快速清空集尘盒. 打开真空吸尘器盖。将另一真空吸尘器的软管置于开口处，清洁集尘盒。



2. Emptying of the dust container. Remove the filters, empty the contents into a dustbin. Return filters and click dust container back into place.

2. 먼지통을 비웁니다. 필터를 제거하고 쓰레기통에 먼지를 버립니다. 필터를 다시 삽입하고 먼지통을 다시 끼워 넣습니다.

2. 清空集尘盒. 取下过滤器，将污物倒入垃圾桶。将过滤器装回并将集尘盒扣回原位。

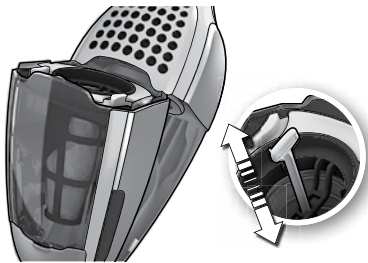

3. Quick cleaning of the fine filter. (Recommended every cleaning). Release the dust container, pull/release spring 5-6 times to dislodge dust.

3. 미세 필터를 신속하게 청소하기. (매번 청소시 권장합니다). 먼지통을 빼서 스프링을 당겼다 다시 놓기를 5 ~ 6회 반복하여 먼지를 제거합니다.

3. 快速清洁细滤器. (建议每次使用后均进行此项清洁)。释放集尘盒，然后拉起/释放弹簧 5-6次以清掉灰尘。



4a. Cleaning of dust container and filters. (Recommended every 5th cleaning). Release dust container, take out both filters by pressing release buttons.

4a. 먼지통 및 필터 청소. (매 5회 사용 후 권장합니다). 먼지통을 뺀 뒤, 해제 버튼을 누르며 필터 두 개를 모두 뺍니다.

4a. 清洁集尘盒和过滤器. (建议每使用5.次后进行此项清洁)。释放集尘盒，按下释放按钮取下所有过滤器。



4b. Separate both filters. Dust container and filters can be shaken clean or rinsed in warm water (never in dishwasher). All parts must be dry before reassembled in reverse order.

4b. 필터 두 개를 모두 분리합니다. 먼지통과 필터는 털어내거나 온수에서 헹굴 수 있습니다. (식기 세척기 사용 금지). 부품을 역순으로 재조립하기 전에 반드시 건조합니다.

4b. 分离两只过滤器. 集尘盒和过滤器可以进行晃动清洁或以温水漂洗(切勿使用洗碗机清洗)。所有部件必须在晾干后按与拆卸时相反的顺序装回。

Cleaning the brush roll with the BRUSHROLLCLEAN™ function* / BRUSHROLLCLEAN™ 기능을 활용하여 브러쉬 롤 청소하기* / 使用 BRUSHROLLCLEAN™ 功能 清洁刷辊*

The brush roll, the hose and the wheels may need to be cleaned if they become blocked or jammed for any reason.

Some Ergorapido models are equipped with **BRUSHROLLCLEAN™** – a brush cleaning function that helps to keep a clean brush easily.

Please note that the **BRUSHROLLCLEAN™** function might not be able to remove thick threads, wires or thick carpet fibres caught in the brush roll.

It is recommended to use this function once a week. For best results use the **BRUSHROLLCLEAN™** function when the Ergorapido is fully charged.

브러쉬 롤, 호스 및 바퀴가 막히거나 걸리는 경우 반드시 청소하시기 바랍니다.

몇몇 Ergorapido 모델에는 **BRUSHROLLCLEAN™** 기능이 포함되어 있습니다. 이 기능은 브러쉬 청소 기능으로서 브러쉬를 손쉽게 청소할 수 있습니다.

BRUSHROLLCLEAN™ 기능으로 두꺼운 실 및 와이어 또는 브러쉬 롤에 낀 두꺼운 카펫 조각을 제거할 수 없는 경우도 있습니다.

이 기능은 매주 1회 정도 사용하기를 권장합니다. 최적의 성능을 누리시려면 **BRUSHROLLCLEAN™** 기능은 Ergorapido가 완전히 충전되었을 때 사용하십시오.

如果刷辊、软管和滚轮因任何原因阻塞不畅，则需要对其进行清理。

部分型号的Ergorapido,配备了**BRUSHROLLCLEAN™**刷头清洁功能，有助于轻松保持刷头的清洁。

请注意，**BRUSHROLLCLEAN™**功能可能无法清除刷辊上吸附的粗线头、金属丝或粗地毯纤维。此项功能建议每周使用一次。

为了获得**BRUSHROLLCLEAN™**功能的最佳效果，请在Ergorapido,已完全充电时使用该功能。

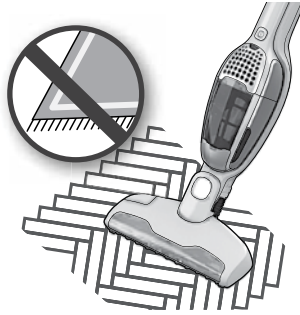

1. Make sure the cleaner is switched on and stands on hard even surface. Do not use the **BRUSHROLLCLEAN™** function on deep carpets or long haired rugs.

1. 클리너가 켜지고 단단하고 균등한 면에 스탠드가 세워졌는지 확인합니다. **BRUSHROLLCLEAN™** 기능은 두꺼운 카펫 또는 긴 털이 있는 양탄자에 사용하지 마십시오.

1. 确保吸尘器已开启并置于坚硬平坦的表面之上。请勿在较厚的地毯或长毛毯上使用 **BRUSHROLLCLEAN™** 功能。



2. Press the **BRUSHROLLCLEAN™** button with your foot while the cleaner is switched on. Hold for ca. 5 seconds or until all dirt and hair is removed. Release the button.

During **BRUSHROLLCLEAN™** use the sound level will be increased which is normal.

2. **BRUSHROLLCLEAN™** 버튼을 클리너가 켜진 상태에서 발로 누릅니다. 약 5초 동안 또는 모든 먼지나 머리카락이 제거될 때까지 누릅니다. 버튼을 해제합니다.

BRUSHROLLCLEAN™ 기능을 사용하는 동안 음압이 증가하는 데 이는 정상입니다.

2. 在吸尘器启动的情况下，用脚踩压 **BRUSHROLLCLEAN™** 功能按钮。保持大约5秒，钟或直至所有污垢和头发均清除干净。松开按钮。

在**BRUSHROLLCLEAN™**使用过程中，噪音将会增大，这是正常现象。

Cleaning the brush roll with the BRUSHROLLCLEAN™ function* / BRUSHROLLCLEAN™ 기능을 활용하여 브러쉬 롤 청소하기* / 使用 BRUSHROLLCLEAN™ 功能`清洁刷辊`

The BRUSHROLLCLEAN™ function is equipped with an overheating protection. It will deactivate the brush roll if the BRUSHROLLCLEAN™ function has been activated for more than 30 sec (constant or interrupted) within one discharging period.

BRUSHROLLCLEAN™에는 과열 방지 기능이 있습니다. 만약 한 방전 기간 동안 BRUSHROLLCLEAN™ 기능이 30초 이상 (지속적 또는 간헐적으로) 작동하는 경우 자동으로 브러쉬 작동이 중지됩니다.

安全的.BRUSHROLLCLEAN™ 功能配有过热保护措施。在一个放电期间，如果 BRUSHROLLCLEAN™ 功能的激活时间超过 30 秒（连续或累计），刷辊将停止工作。

1. Ergorapido plus:

If - while holding the BRUSHROLLCLEAN™ button pressed down – the brush stops rotating, the nozzle front lights -switch off and the battery indicator light blinks red and blue, release the BRUSHROLLCLEAN™ button.

1. Ergorapido plus:

BRUSHROLLCLEAN™ 버튼을 누르는 동안 브러쉬가 회전을 멈추거나, 노즐 전면등이 꺼지는 경우, BRUSHROLLCLEAN™ 버튼을 해제합니다.

1. Ergorapido 增强版 :

如果按下 BRUSHROLLCLEAN™ 按钮时刷头停止转动，吸头正面指示灯熄灭，并且电池指示灯闪烁红、蓝两色，请松开.BRUSHROLLCLEAN™ 按钮。

2. Ergorapido:

If - while holding the BRUSHROLLCLEAN™ button pressed down – the brush stops rotating and the nozzle front lights switch off, release the BRUSHROLLCLEAN™ button.

2. Ergorapido:

BRUSHROLLCLEAN™ 버튼을 누르는 동안 브러쉬가 회전을 멈추거나 노즐 전면등이 꺼지는 경우, BRUSHROLLCLEAN™ 버튼을 해제합니다.

2. Ergorapido :

如果按下.BRUSHROLLCLEAN™ 按钮时刷头停止转动，并且吸头正面指示灯熄灭，请松开 BRUSHROLLCLEAN™ 按钮。

When the button is released, the brush is rotating and the nozzle front lights are on again. You can continue to use the Ergorapido for vacuuming as usual. The BRUSHROLLCLEAN™ function will remain disabled. To reset, the Ergorapido must be charged continuously for at least 10 minutes in the charging stand.

버튼이 해제되면, 브러쉬는 다시 회전하고 노즐 전면등은 다시 켜지게 됩니다. 그 뒤 Ergorapido 제품을 다시 평상시처럼 진공 청소기로 사용할 수 있습니다. BRUSHROLLCLEAN™ 기능은 계속 꺼진 상태를 유지합니다. 재설정하려면, Ergorapido를 반드시 10분 이상 지속적으로 충전대에서 충전해야 합니다.

松开按钮时，刷头和吸头正面指示灯将再次旋转和点亮。您可以继续正常使用.Ergorapido.进行清洁。此时.BRUSHROLLCLEAN™.功能将保持禁用状态。要重置此功能，必须将.Ergorapido.置于充电基座上持续充电至少.10.分钟。

GB

KOR

CHS

CHT

THA

IND

VIE

Cleaning the brush roll / 브러쉬 롤 청소 / 清洁刷辊

To remove thicker threads or wires as well as on models that are not equipped with the **BRUSHROLLCLEAN™**, the brush should be cleaned according to the following instructions.

BRUSHROLLCLEAN™ 이 장착되어 있지 않은 모델을 포함하여 두꺼운 실이나 와이어를 제거하려면, 브러쉬를 다음 절차에 따라 청소합니다.

要去除吸附的较粗线头或金属丝，无论吸尘器的型号是否具有 **BRUSHROLLCLEAN™** 功能，均应按照以下说明清洁刷头。

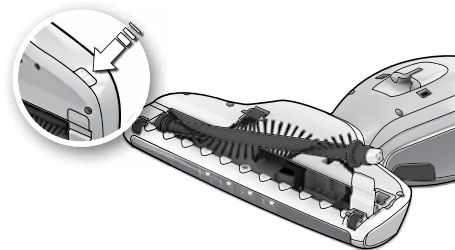

1. First turn Ergorapido off. Push the brush roll release button. The hatch cover will come slightly free and the brush roll can be removed.

1. 먼저 Ergorapido 의 전원을 끕니다. 그 뒤 브러쉬 롤 해제 버튼을 누릅니다. 해치 커버가 약간 열리면서 브러쉬 롤을 뺄 수 있습니다.

1. 首先关闭 Ergorapido. 按下刷辊释放按钮。刷辊盖会微微松开，此时可以取出刷辊。

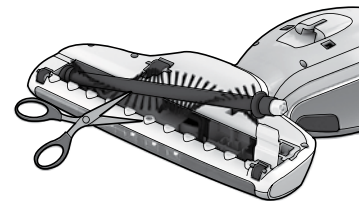

2. Lift out the brush roll and clean it. Use a sharp object to remove threads. Reassemble the roll, making sure it can spin freely. Close hatch cover.

2. 브러쉬 롤을 들어올려 청소합니다. 날카로운 물체를 사용하여 실을 제거합니다. 롤이 자유롭게 회전할 수 있도록 재조립합니다. 해치 커버를 닫습니다.

2. 向上拉出刷辊并进行清洁。 使用尖锐物体去除吸附的线头。将刷辊装回原位，并确认其可自由转动。合上刷辊盖。

Cleaning the hose and wheels / 호스 및 바퀴 청소 / 清洁软管和滚轮

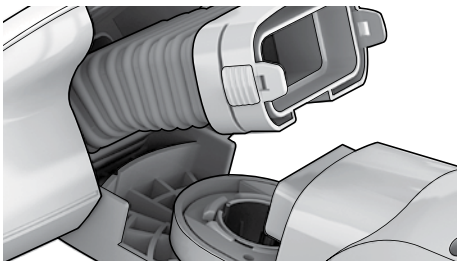

1. Loosen the catch and pull the hose from the attachment. Remove any debris. Put the hose back, lock using the catch.

1. 걸쇠를 풀 뒤 제품에 부착되어 있는 호스를 잡아 당깁니다. 이물질을 제거합니다. 호스를 다시 넣고 걸쇠를 걸어 잠급니다.

1. 松开卡扣。 并将软管从连接装置中拉出。清除污垢。装回软管并锁紧卡扣。

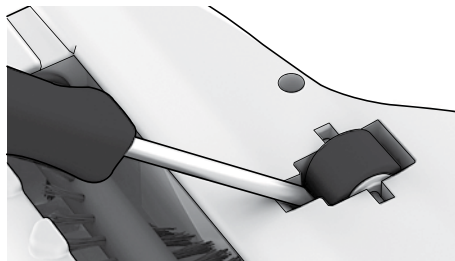

2. If the wheels need to be cleaned, remove them carefully by using a small screwdriver.

2. 바퀴를 청소하려면, 작은 드라이버로 바퀴를 주의하여 빼냅니다.

2. 如果需要清洁滚轮，使用小号螺丝刀小心取下滚轮。

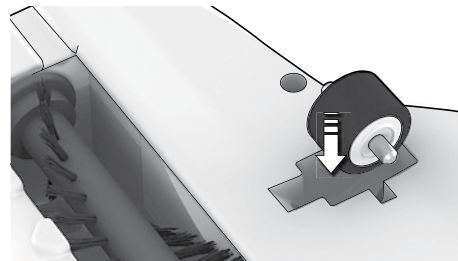

3. Remove objects that may have become jammed in the wheel shafts. Reassemble the wheels by pressing them back into their tracks.

3. 바퀴 축에 끼여있는 물체가 있다면 제거합니다. 트랙에 바퀴를 다시 눌러 놓으면서 재조립합니다.

3. 清除轮轴上可能造成阻塞的物体。 通过按压将滚轮装回滚轮槽。

Removing the batteries / 배터리 제거 / 取出電池

Improper handling of the batteries may be hazardous. Return the complete handheld unit to a recycling station. Batteries must be removed from the appliance before it is scrapped or recycled.

Never dispose used batteries with household waste.

배터리를 부적절하게 사용하는 것은 위험합니다. 제품을 분리하지 않은 완전한 형태의 휴대용 제품은 재활용으로 분리수거합니다. 제품을 폐기하거나 재활용하려면 제품에서 배터리를 제거합니다.

사용한 배터리는 가정용 쓰레기와 함께 버리지 않습니다.

对电池的处理不当可能会带来危险。请将完整的手持组件送至回收站。在销毁或回收本设备之前，请务必先取下电池。

切勿将使用过的电池与生活垃圾一起处理。

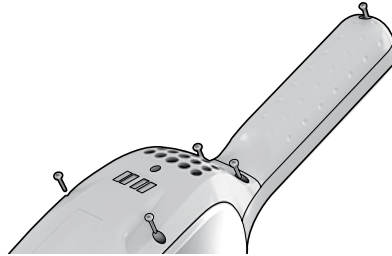

1. Batteries should always be run flat before removed. **Ergorapido must be disconnected from the charging station when removing the batteries.** Undo the screws. Carefully lift the hood.

1. 배터리를 제거하기 전에 다 소모되었는지 먼저 확인합니다. 배터리를 제거하기 전에 Ergorapido를 먼저 충전 스테이션에서 분리합니다. 나사를 풀니다. 덮개를 주의하여 들어올립니다.
2. 取出電池前，应始终确保电量已耗尽。取出電池时，务必要断开 Ergorapido 与充电站的连接。拧下螺丝。小心地抬起盖板。

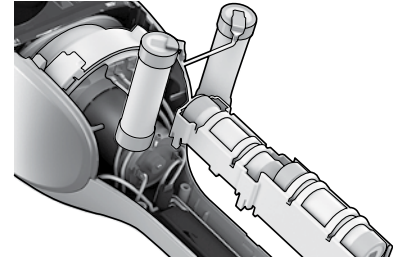

2. **Cut the connecting cables**, remove the batteries, put tape over the visible metal areas. Place batteries in suitable packaging.

2. 연결 케이블을 분리하고, 배터리를 제거한 후, 금속이 보이는 부분에 테이프를 붙입니다. 적절한 봉투에 배터리를 넣습니다.
2. 切断连接线缆，取下电池，在裸露的金属区域上包裹绝缘带。将电池放置在适当的包装中。

GB
KOR
CHS

CHT
THA
IND

VIE

Safety precaution

Ergorapido should only be used by adults and only for normal vacuuming in a domestic environment. Make sure the vacuum cleaner is stored in a dry place. All servicing and repairs must be carried out by an authorized Electrolux service centre.

This appliance is not intended for use by persons (including children) with reduced physical, sensory or mental capabilities, or lack of experience and knowledge, unless they have been given supervision or instruction concerning use of the appliance by a person responsible for their safety.

Please remove the plug from the socket outlet before cleaning or maintaining the appliance.

Children should be supervised to ensure that they do not play with the appliance.

Packaging material, e.g. plastic bags should not be accessible to children to avoid suffocation.

Each vacuum cleaner is designed for a specific voltage. Check that your supply voltage is the same as that stated on the rating plate on the charging adaptor. Use only the original charging adaptor designed for this model.

Never use the vacuum cleaner:

- In wet areas.
 - Close to flammable gases, etc.
 - When housing shows visible signs of damage.
 - On sharp objects or fluids.
 - On hot or cold cinders, lighted cigarette butts, etc.
 - On fine dust, for instance from plaster, concrete, flour, hot or cold ashes.
-
- Do not leave the vacuum cleaner in direct sunlight.
 - Avoid exposing the vacuum cleaner or battery to strong heat.
 - The battery must not be dismantled, short-circuited, placed against a metal surface or exposed to strong heat.
 - Never use the vacuum cleaner without its filters.
 - **Do not try to touch the brush roll while the cleaner is switched on and the brush roll is turning.**

Using the vacuum cleaner in the above circumstances may cause serious damage to the product. Such damage is not covered by the warranty.

안전 주의사항

Ergorapido는 반드시 성인이 사용해야 하며 가정의 정상적인 진공 청소시에만 사용해야 합니다. 본 진공 청소기는 반드시 건조한 환경에서 보관해야 합니다. 모든 서비스와 수리는 공인 Electrolux 서비스 센터에서 받으셔야 합니다.

이 제품은 신체적, 감각적, 또는 정신적 능력이 저하되거나 경험과 지식이 부족한 사람(어린이 포함)의 사용을 제한합니다. 부득이하게 사용되는 경우, 제품의 안전을 책임질 수 있는 사람의 감독 또는 주의가 요구됩니다.

제품을 청소하거나 유지보수 하기 전에 반드시 콘센트에서 전원 코드를 분리합니다.

어린이가 제품을 가지고 장난하지 않도록 세심한 주의를 기울여야 합니다.

질식사를 방지하기 위해 포장재, 특히 비닐봉지는 아이가 만질 수 없는 곳에 보관해야 합니다.

각 진공 청소기에는 고유 전압이 지정되어 있습니다. 충전 어댑터에 표시된 정격 전압과 가정의 공급 전압이 일치하는지 확인합니다.

다음과 같은 상황에서 진공 청소기 사용을 금합니다.

- 습기가 있는 지역
 - 인화성 가스 및 기타 유사한 물질과 인접한 지역
 - 제품의 외관 손상 정도가 분명하게 드러난 경우
 - 날카로운 물체 또는 액체 위
 - 뜨겁거나 차가운 담뱃재 또는 불이 붙어 있는 담배 공초 등
 - 미세 먼지, 석고, 콘크리트, 밀가루 및 뜨겁거나 차가운 재가 있는 환경
-
- 직사광선에 진공 청소기를 두지 마십시오.
 - 열이 강한 곳에 진공 청소기 또는 배터리를 두지 마십시오.
 - 배터리를 분리하거나 단락시킨 상태로 보관하지 않으며, 금속 표면에 접촉하거나 강력한 열 근처에 두지 마십시오.
 - 필터를 삽입하지 않은 채로 청소기를 사용하면 안됩니다.
 - 클리너가 켜져 있고 브러쉬 롤이 회전하고 있는 경우에는 브러쉬 롤을 만지지 마십시오.

위와 같은 상황에서 진공 청소기를 사용하면 제품에 심각한 손상을 입힐 수 있습니다. 또한 그렇게 발생한 손상은 품질 보증 혜택을 받으실 수 없습니다.

安全防范措施

Ergorapido .仅应由成年人操作，并且仅用于家庭环境的普通吸尘清洁。请确保将真空吸尘器存放于干燥处。所有服务或维修均应由授权的伊莱克斯服务中心进行。

本设备不可由肢体伤残、感觉或精神障碍以及缺乏相关经验和知识的人员(包括儿童)使用，除非有安全负责人对其进行看管或指导。

在对本产品进行清洁或维护之前，请将电源插头从插座中拔出。

应对儿童施加看管，确保他们不将本产品作为玩具。

塑料袋等包装材料应放置在儿童不易接近的地方，以免造成窒息危险。

每款真空吸尘器都有特定的电压设计。请检查您的供电电压是否与充电适配器铭牌上的标称电压一致。请仅使用为本型号产品设计的原装充电适配器。

切勿在以下情况下使用真空吸尘器：

- 在潮湿环境中。
 - 靠近易燃气体等。
 - 产品外壳出现明显损坏迹象时。
 - 在尖锐物体或液体之上。
 - 在热或冷的炭渣、未熄灭的烟蒂等污物之上。
 - 在细粉尘(例如石膏粉、水泥、面粉以及热或冷的灰烬)之上。
-
- 避免真空吸尘器受到阳光直射。
 - 避免真空吸尘器或其电池暴露于高温环境下。
 - 电池不得拆解、短接、接触金属表面或暴露于高温环境下。
 - 切勿在未安装过滤器的情况下使用真空吸尘器。
 - 请勿在吸尘器尚未关闭并且刷辊仍在转动时触碰刷辊。

在上述情况下使用真空吸尘器可能会导致产品严重损坏。此类损坏不在产品质量范围之内。

Consumer information

Servicing or repairs

In cases of breakdown or faults, your Ergorapido must be taken to an authorized Electrolux service centre. If the supply cord or charger is damaged, it must be replaced by Electrolux or its service agent or an equally qualified person in order to avoid a hazard.

Consumer information

Share more of our thinking at www.electrolux.com



The symbol  on the product or on its packaging indicates that this product may not be treated as household waste. Instead it should be handed over to the applicable collection point for the recycling of electrical and electronic equipment. By ensuring this product is disposed of correctly, you will help prevent potential negative consequences for the environment and human health, which could otherwise be caused by inappropriate waste handling of this product. For more detailed information about recycling of this product, please contact your local city office, your household waste disposal service or the shop where you purchased the product.

소비자 정보

서비스 또는 수리

고장이나 제품에 이상이 발견되면 반드시 Ergorapido 제품을 공식 Electrolux 서비스 센터로 가져가시기 바랍니다. 전원 코드 및 충전기가 손상된 경우 위험을 방지하려면 Electrolux, 서비스 대리점 또는 동등한 자격을 갖춘 전문가가 교환해야 합니다.

애프터 서비스

www.electrolux.com에서 더 많은 정보를 확인하십시오.



제품 또는 포장재 상의 기호  는 이 제품을 일반 가정용 폐기물로 처리해서는 안 됨을 나타냅니다. 그 대신 전기 및 전자 장비 재활용을 담당하는 해당 수집소에 보내서 처리하도록 해야 합니다. 제품을 올바르게 폐기 처분하면 환경과 인류에 미치는 잠재적인 부정적 영향을 방지할 수 있습니다. 이 제품의 재활용에 관한 자세한 설명은 가까운 동사무소, 가정용 폐기물 서비스 센터 또는 제품 구입처로 문의하시기 바랍니다.

用户须知

服务或维修

您的 Ergorapido 如遇到故障或存在问题，必须送至伊莱克斯授权的服务中心。如果电源线或充电器损坏，必须由伊莱克斯或其维修代理或具备同等资质的人员进行更换，以免发生危险。

用户须知

体验更多新鲜创意，尽在 www.electrolux.com



产品或其包装上的  符号表示本产品不可作为生活垃圾处理，而应交至相应的回收站进行电气和电子设备的回收利用。确保合理处置本产品，有助于防止本产品废弃物的处理不当可能对环境和人体健康造成的负面影响。有关回收利用本产品的更多详细信息，请联系您当地的城市办事处、生活垃圾处理服务站或您购买产品的商店。

GB

KOR

CHS

CHT

THA

IND

VIE

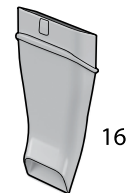
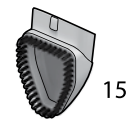
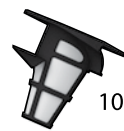
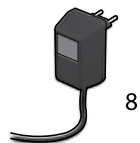
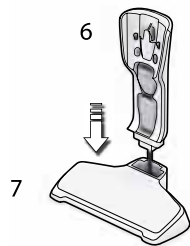
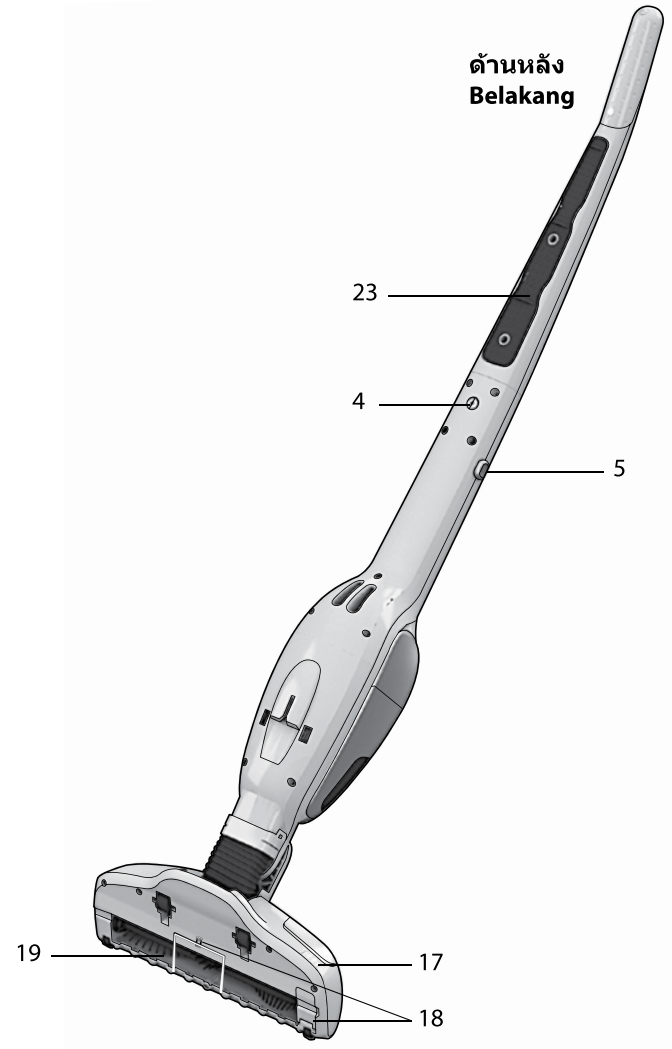
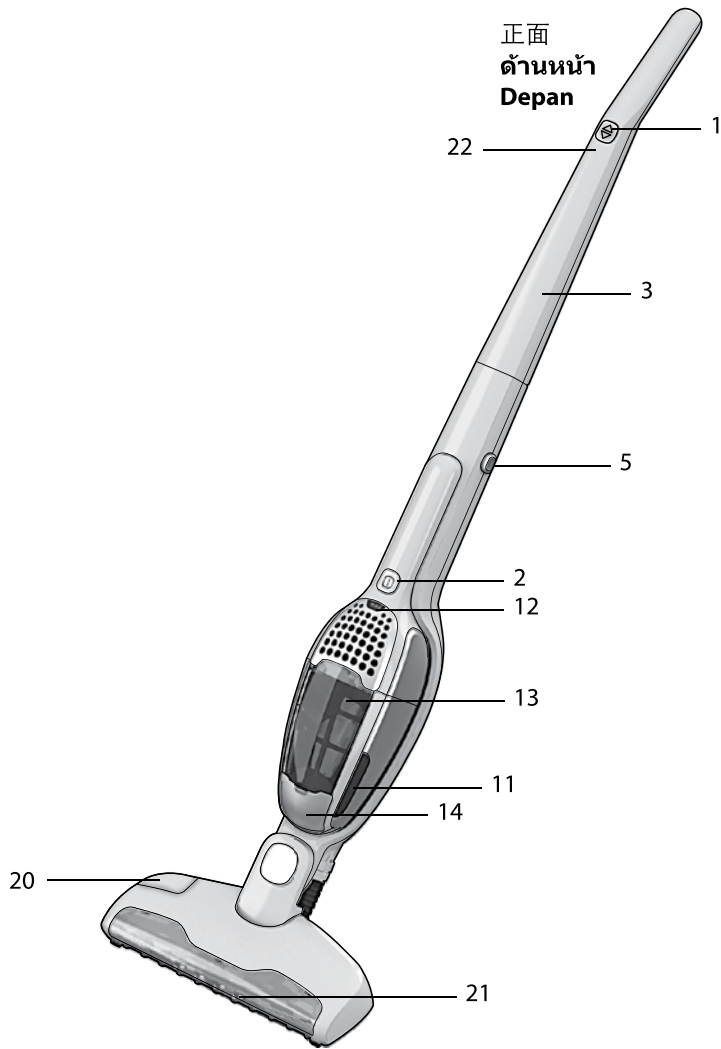

繁體中文

目錄
 拆封與組裝.....16
 充電.....17
 使用吸塵器.....18
 清空與保養.....19
 清潔滾刷、軟管與轉輪.....20
 移除電池.....23
 安全注意事項.....24
 消費者資訊.....25

功能/配件

1 開/關按鈕
 2 手持裝置開/關按鈕
 3 手把
 4 鎖定螺絲
 5 手持裝置釋放按鈕
 6 壁式充電座
 7 座充式充電座
 8 變壓器
 9 細濾網 (內部濾網)
 10 前濾網 (外部濾網)
 11 集塵盒釋放按鈕
 12 電池顯示，鋰電池版本*
 13 集塵盒
 14 集塵盒前蓋
 15 毛刷
 16 細縫吸頭
 17 滾刷釋放按鈕*
 18 滾刷蓋*
 19 滾刷
 20 BRUSHROLLCLEAN™ 按鈕*
 21 吸頭前指示燈
 22 充電顯示燈，鎳氫電池版本*
 23 止滑桿

ไทย

สารบัญ
 การแกะหีบห่อบรรจุและการประกอบเครื่อง..... 16
 การชาร์จไฟ..... 17
 การดูดฝุ่น..... 18
 การเทฝุ่นและการทำความสะอาด..... 19
 การทำความสะอาดแปรงลูกกลิ้ง ท่อดูด และล้อ..... 20
 การถอดแบตเตอรี่..... 23
 มาตรการด้านความปลอดภัย..... 24
 ข้อมูลผู้บริโภค..... 25

คุณสมบัติ/อุปกรณ์เสริม

1 ปุ่มเปิด/ปิด
 2 ปุ่มเปิด/ปิด, เครื่องดูดฝุ่นชนิดมือถือ
 3 ด้ามจับ
 4 สกรูล็อค
 5 ปุ่มปลดล็อค, เครื่องดูดฝุ่นชนิดมือถือ
 6 แท่นชาร์จแบบติดกับผนัง
 7 แท่นชาร์จแบบวางกับพื้น
 8 อะแดปเตอร์
 9 แผ่นกรองฝุ่นชนิดละเอียด (แผ่นกรองภายใน)
 10 แผ่นกรองฝุ่นชนิดหยาบ (แผ่นกรองด้านนอก)
 11 ปุ่มปลดล็อค, กล้องเก็บฝุ่น
 12 ไฟสัญญาณแบตเตอรี่, รุ่นลิเทียม*
 13 กล้องเก็บฝุ่น
 14 ฝาปิดเครื่องดูดฝุ่น
 15 แปรง
 16 หัวดูดสำหรับซอกมุม
 17 ปุ่มปล่อยแปรงลูกกลิ้ง*
 18 ฝาครอบสำหรับแปรงลูกกลิ้ง*
 19 แปรงลูกกลิ้ง
 20 ปุ่ม BRUSHROLLCLEAN™ *
 21 ไฟที่ด้านหน้าหัวดูด
 22 ไฟสัญญาณการชาร์จ, รุ่น NiMH*
 23 แถบยางกันลื่น

Bahasa Indonesia

Daftar isi
 Membuka kemasan dan merakit.....16
 Mengisi daya.....17
 Menyedot debu.....18
 Mengosongkan dan membersihkan.....19
 Membersihkan rol sikat, selang, dan roda.....20
 Mengeluarkan baterai.....23
 Tindakan pencegahan demi keselamatan.....24
 Informasi bagi konsumen.....25

Fitur/Aksesoris

1 Tombol On/Off
 2 Tombol On/Off, unit genggam
 3 Handel
 4 Sekrup pengunci
 5 Tombol pelepas, unit genggam
 6 Stasiun pengisian daya, unit dinding
 7 Stasiun pengisian daya, unit lantai
 8 Adaptor
 9 Filter halus (filter dalam)
 10 Pra-filter (filter luar)
 11 Tombol pelepas, kantong debu
 12 Layar baterai, versi Litium*
 13 Kantung debu
 14 Tutup penyedot debu
 15 Sikat
 16 Nosel berongga
 17 Tombol pelepas rol sikat*
 18 Tutup untuk rol sikat*
 19 Rol sikat
 20 Tombol BRUSHROLLCLEAN™ *
 21 Lampu depan nosel
 22 Indikator pengisian daya, versi NiMH*
 23 Strip parkir

* 仅限特定機型

* บางรุ่นเท่านั้น

* Hanya model tertentu

拆封及組合 / การแกะหีบห่อบรรจุและการประกอบเครื่อง / Membuka kemasan dan merakit

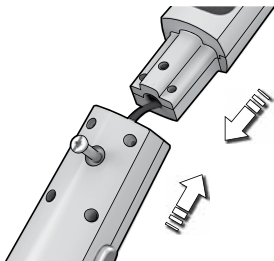

1. 檢查是否所有的零件都在包裝箱內，將手柄小心插入吸塵器中，確認別讓電線纏住。

1. ตรวจสอบว่าชิ้นส่วนทั้งหมดอยู่ในกล่อง ติดตั้งด้ามจับ โดยค่อยๆ สวมเข้ากับตัวเครื่องหลัก ตรวจสอบให้แน่ใจว่าไม่มีสายไฟพันกัน

1. Periksa bahwa komponen di dalam kotak sudah lengkap. Pasang handel dengan memasukkannya ke bodi utama bagian bawah. Pastikan kabelnya tidak tersangkut.



2. 使用螺絲起子或硬幣將內附的螺絲鎖緊，以讓手柄不會鬆動。

2. ยึดด้ามจับให้เข้าที่อย่างแน่นหนา โดยใช้สกรูล๊อคที่ให้มา ใช้ไขควงหรือเหรียญ

2. Pasang handel dengan mengencangkan sekrup pengunci yang disertakan. Gunakan obeng atau koin.

充電座 / แท่นชาร์จ / Stasiun pengisian daya

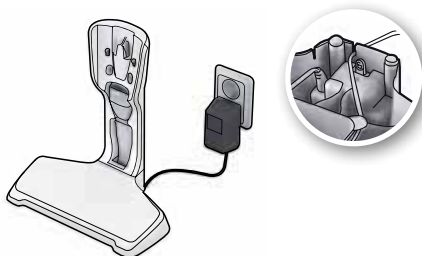

1. 讓充電座遠離熱源、陽光直射或潮濕的地方。把變壓器插入電源插座，接上充電座。

1. จัดวางแท่นชาร์จ ให้ห่างจากแหล่งความร้อน แสงแดดที่ส่องกระทบโดยตรง หรือบริเวณที่เปียกชื้น เลี่ยงอะแดปเตอร์เข้ากับสายเมน และเชื่อมต่อกับแท่นชาร์จ

1. Letakkan stasiun pengisian daya jauh dari sumber panas, sinar matahari langsung, atau tempat yang lembab. Colokkan adaptor ke stopkontak listrik dan sambungkan ke stasiun pengisian daya.

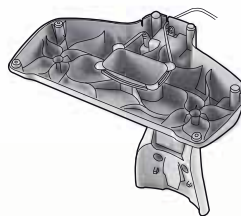

2. 充電座底部有一個中空區域，可將多餘的電線捲起並收藏其中。

2. ที่ส่วนล่างของแท่นชาร์จ มีช่องว่างสำหรับเก็บสายไฟที่ไม่ได้ใช้

2. Di bagian bawah stasiun pengisian daya ada ruang kosong untuk menggulung kabel yang tidak digunakan.

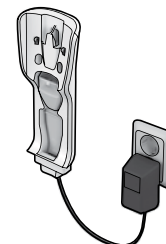

3. 壁式充電座也可以安裝在牆壁上。請先將壁掛式充電座與底座分離。請務必確保牆壁可承受 Ergorapido 的重量。

3. แท่นชาร์จแบบติดกับผนัง สามารถยึดติดไว้กับผนังได้ โดยแยกออกจากแท่นชาร์จแบบวางกับพื้น ตรวจสอบให้แน่ใจว่าผนังสามารถรับน้ำหนักของ Ergorapido

3. Unit dinding juga dapat dipasang di dinding. Pisahkan dari unit lantai. Periksa dan pastikan bahwa dinding cukup kuat untuk menahan berat Ergorapido.

充電 / การชาร์จไฟ / Mengisi daya

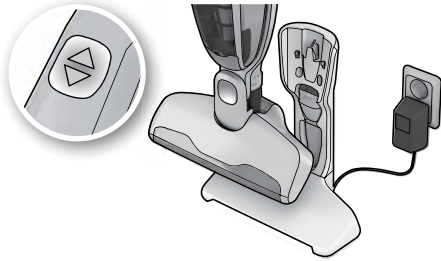

1. **Ergorapido:** 將 Ergorapido 正確放置於充電座之後，指示燈將會亮起。電量充飽後，LED 燈每分鐘會持續亮起數秒鐘。

1. **Ergorapido:** ไฟสัญญาณจะติดสว่างในทันทีที่ Ergorapido ถูกตั้งวางในแท่นชาร์จอย่างถูกต้อง เมื่อชาร์จไฟจนเต็ม ไฟสัญญาณจะติดสว่างนาน 2-3 วินาทีต่อนาที

1. **Ergorapido:** Lampu indikator akan hidup setelah Ergorapido diletakkan dengan benar di stasiun pengisian daya. Apabila pengisian daya penuh, LED akan hidup selama beberapa detik setiap menitnya.

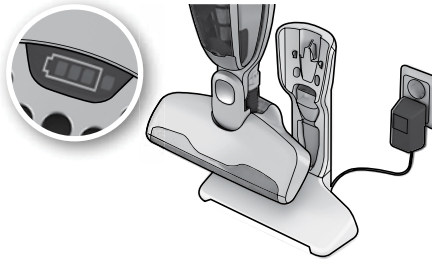

2. **Ergorapido Plus:** 將吸塵器正確放置於充電座之後，電池電量顯示燈號會接連亮起。

2. **Ergorapido Plus:** ไฟแสดงประจุแบตเตอรี่จะติดสว่างทีละดวงขณะที่กำลังชาร์จไฟหลังจากที่ตั้งวางในแท่นชาร์จอย่างถูกต้อง

2. **Ergorapido Plus:** Lampu layar kapasitas baterai akan saling hidup bergantian saat mesin diisi daya setelah diletakkan dengan benar di stasiun pengisian daya.

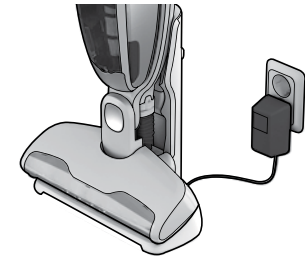

3. 完全放電後，會需要約 16 小時充飽至全電量 (Ergorapido Plus 為 4 小時)。沒有使用時，請讓 Ergorapido 保持充電狀態以維持電池效能。

3. **เมื่อคายประจุไฟจนหมด** ต้องชาร์จไฟประมาณ 16 ชั่วโมงเพื่อให้แบตเตอรี่มีไฟเต็มอีกครั้ง (4 ชั่วโมงสำหรับ Ergorapido Plus) เมื่อไม่ได้ใช้งาน ให้วาง Ergorapido ไว้ที่แท่นชาร์จ เพื่อรักษาประสิทธิภาพของแบตเตอรี่

3. **Apabila daya benar-benar habis,** diperlukan waktu mengisi daya sekitar 16 jam hingga kapasitas baterai penuh (4 jam untuk Ergorapido Plus). Isi daya Ergorapido saat tidak digunakan untuk mempertahankan performa baterai.

電池電量顯示* / การแสดงระดับประจุไฟในแบตเตอรี่* / Layar kapasitas baterai*



1. 3 個藍燈：電池電量 > 75%
2 個藍燈：電池電量 75-25%
1 個藍燈：電池電量 < 25%
1 個閃爍藍燈：電池電量--用完

1. ไฟสีฟ้า 3 ดวง: ประจุแบตเตอรี่ >75%
ไฟสีฟ้า 2 ดวง: ประจุแบตเตอรี่ 75-25%
ไฟสีฟ้า 1 ดวง: ประจุแบตเตอรี่ <25%
ไฟกะพริบสีฟ้า 1 ดวง: ประจุแบตเตอรี่ - ว่างเปล่า

1. 3 lampu biru: kapasitas baterai >75%
2 lampu biru: kapasitas baterai 75-25%
1 lampu biru: kapasitas baterai <25%
1 lampu biru berkedip: kapasitas baterai - kosong



2 如果紅燈亮起：裝置太熱。清理濾網、滾刷、軟管，然後開始充電。
3. 如果紅燈正在閃爍：馬達超載。請清理滾刷。

2 **หากไฟติดเป็นสีแดง:** ตัวเครื่องร้อนเกินไป ทำความสะอาดแผ่นกรอง แปรงลูกกลิ้ง ท่อดูด และชาร์จไฟ
3. **หากไฟกะพริบเป็นสีแดง:** มอเตอร์ทำงานหนักเกินไป ทำความสะอาดแปรงลูกกลิ้ง

2 **Apabila lampu merah hidup:** Unit terlalu panas. Bersihkan filter, rol sikat, selang dan isi daya.
3. **Apabila lampu merah berkedip:** Motor kelebihan beban. Bersihkan rol sikat.



4. 電量充飽：LED 燈將熄滅並進入待機模式，此時耗電量極低，燈號會每分鐘閃爍一次。
5. 如果紅燈與藍燈同時閃爍：請參考第 21 頁。

4. **เมื่อชาร์จไฟจนเต็ม:** ไฟสัญญาณจะดับลง และเข้าสู่โหมดสแตนด์บาย = ใช้พลังงานน้อยลงอย่างมาก, ไฟกะพริบหนึ่งครั้งต่อนาที
5. **หากไฟกะพริบเป็นสีแดงและสีฟ้า:** โปรดดูหน้า 9

4. **Apabila pengisian daya penuh:** LED akan mati dan masuk ke mode siaga = konsumsi daya jauh lebih rendah, ditandai dengan satu kali berkedip setiap menitnya.
5. **Apabila lampu merah dan biru berkedip:** baca halaman 9.

使用吸塵器 / การดูดฝุ่นบนพื้นและพรม / Menyedot debu di lantai dan karpet

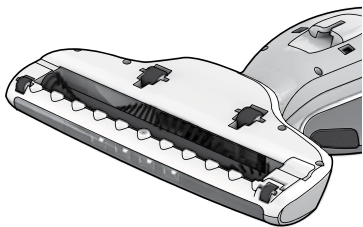

1. 您應當定期檢查以確保噴嘴滾輪及刷輓清潔，以便防止刮傷脆弱的地板。

1. ควรมีการตรวจสอบเป็นประจำว่าล้อและแปรงสะอาด เพื่อป้องกันไม่ให้พื้นเกิดรอยขีดข่วน

1. **Anda harus rutin memeriksa** kebersihan roda nosel dan rol sikat untuk menghindari goresan pada lantai yang sensitif.

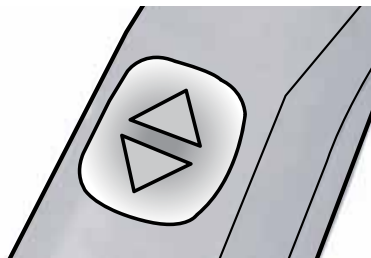

2. 按下開/關按鈕以可啟動 Ergorapido。

2. เริ่มการทำงานของ Ergorapido โดยกดปุ่มเปิด/ปิดเครื่อง

2. Hidupkan Ergorapido dengan menekan tombol on/off.

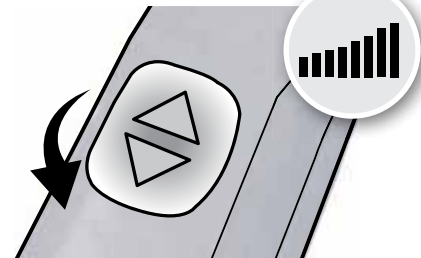

3. 按「開/關」按鈕的下半位置以調整電力等級：

3. ปรับระดับพลังงาน โดยกดส่วนล่างของปุ่มเปิด/ปิดเครื่อง.

3. Setel level daya dengan menekan bagian bawah tombol on/off.

在傢俱、汽車座椅等使用吸塵器 / การดูดฝุ่นบนเฟอร์นิเจอร์ เมาะที่นั่งในรถยนต์ ฯลฯ / Menyedot debu mebel, jok mobil, dsb.

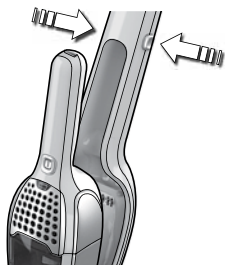

1. 按下釋放按鈕，就可取下手持裝置。縫隙吸頭和小刷子存放在充電座內。

1. ถอดเครื่องดูดฝุ่นชนิดมือถือออกโดยกดที่ปุ่มคลายล็อค หัวดูดสำหรับซอกมุมและแปรงขนาดเล็ก จะเก็บอยู่ในแท่นชาร์จ

1. **Lepaskan unit genggam dengan menekan tombol pelepas.** Nosel berongga dan sikat kecil disimpan di stasiun pengisian daya.

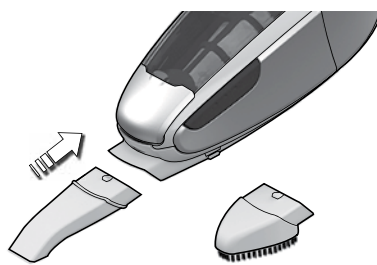

2. 把縫隙吸頭裝到吸塵器上，可以清理較難清理到的地方，或裝上刷子吸頭清除灰塵。

2. ประกอบหัวดูดสำหรับซอกมุมเข้ากับเครื่องดูดฝุ่น เพื่อช่วยทำความสะอาดบริเวณที่เข้าถึงได้ยาก หรือประกอบแปรงสำหรับขัดฝุ่น

2. **Pasang nosel berongga** untuk membantu membersihkan bagian yang sulit dijangkau, atau pasang sikat untuk membersihkan debu.



3. 只要按下啟動按鈕，即可啟動/停止手持裝置。

3. ให้เปิด/ปิดการทำงานของเครื่องดูดฝุ่นชนิดมือถือด้วยการกดปุ่มเปิด

3. Hidupkan/matikan unit genggam dengan menekan tombol start.

清空與保養

請定期清空 Ergorapido 集塵盒並清理集塵盒與濾網以維持強勁的吸力。

切勿在洗碗機裡清洗集塵盒或濾網。

การเทฝุ่นและการทำความสะอาด

เทฝุ่นในกล่องเก็บฝุ่นของ Ergorapido ให้อย่างสม่ำเสมอ และหมั่นทำความสะอาดกล่องเก็บฝุ่นและแผ่นกรองเป็นประจำเพื่อรักษาแรงดูดของเครื่องดูดฝุ่น

ห้ามล้างกล่องเก็บฝุ่นหรือแผ่นกรองโดยใช้เครื่องล้างจาน

Mengosongkan dan membersihkan

Kantung debu Ergorapido harus dikosongkan secara rutin dan kantong debu serta filter harus dibersihkan untuk mempertahankan kekuatan sedotannya.

Jangan mencuci kantong debu atau filter di bak cuci piring.

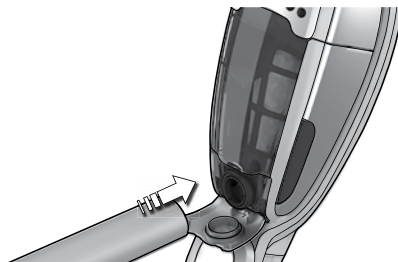

1. 快速淨空集塵盒。打開吸塵器蓋子。將另一台吸塵器的軟管放到蓋子開口處來清理集塵盒。

1. การเทฝุ่นในกล่องเก็บฝุ่นอย่างรวดเร็ว เปิดฝาครอบเครื่องดูดฝุ่น ดุดทำความสะอาดกล่องเก็บฝุ่นด้วยการประกอบท่อดูดของเครื่องดูดฝุ่นอีกเครื่องหนึ่งเข้ากับช่องเทฝุ่น

1. Kosongkan kantong debu dengan cepat. Buka tutup penyedot debu. Bersihkan kantong debu dengan meletakkan selang penyedot debu lainnya di depan lubang.



2. 淨空集塵盒。取下濾網，然後將集塵盒內含物淨空到垃圾桶中。放回濾網，並將集塵盒扣回原位。

2. การเทฝุ่นในกล่องเก็บฝุ่น ถอดแผ่นกรอง เทฝุ่นลงในถังขยะ ใส่แผ่นกรองกลับเข้าที่ และกดกล่องเก็บฝุ่นกลับเข้าที่ตามเดิมจนกระทั่งล็อกเข้าที่

2. Kosongkan kantong debu. Lepaskan filter, buang kotoran ke keranjang sampah. Pasang kembali filter dan kantong debu ke tempatnya.

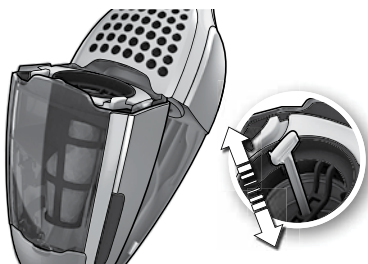

3. 快速清理內部濾網。(建議每次使用後清理)。取下集塵盒，然後拉起並放開過濾網的彈簧 5 - 6 次，以便清除濾網上的灰塵。

3. การทำความสะอาดแผ่นกรองแบบละเอียดอย่างรวดเร็ว (ควรทำหลังจากการใช้งานทุกครั้ง) ถอดกล่องเก็บฝุ่น ดึง/ปล่อยสปริง 5-6 ครั้ง เพื่อกำจัดฝุ่นออกจากแผ่นกรอง

3. Membersihkan filter halus dengan cepat. (Disarankan setelah membersihkan). Lepaskan kantong debu, tarik/lepaskan pegas 5-6 kali untuk mengeluarkan debu.



- 4a. 清理集塵盒與濾網。(建議每使用5次後清理一次)。取下集塵盒，並按釋放按鈕分別取出內外兩個濾網。

- 4a. การทำความสะอาดกล่องเก็บฝุ่นและแผ่นกรอง (ควรทำหลังจากการใช้งานทุก 5 ครั้ง) ถอดกล่องเก็บฝุ่นออก ถอดแผ่นกรองทั้งสองออกโดยกดปุ่มคลายลอค

- 4a. Membersihkan kantong debu dan filter. (Disarankan setelah 5 kali membersihkan). Lepaskan kantong debu, keluarkan kedua filter dengan menekan tombol pelepas.



- 4b. 分開放置兩個濾網。集塵盒與濾網可以用手抖動的方式，或用溫水清潔、洗淨(請勿放到洗碗機內清洗)。以相反順序重新組合前，先確定所有零件都已乾燥。

- 4b. แยกแผ่นกรองทั้งสองออกจากกัน ทำความสะอาดกล่องเก็บฝุ่นและแผ่นกรองด้วยการเคาะเบาๆ หรือล้างด้วยน้ำอุ่น (ห้ามทำความสะอาดด้วยเครื่องล้างจาน) ชิ้นส่วนทั้งหมดต้องแห้งสนิทก่อนประกอบกลับเข้าไปใหม่ในลำดับย้อนหลัง

- 4b. Pisahkan kedua filter. Kantong debu dan filter dapat diguncangkan hingga bersih atau dibilas dengan air hangat (bukan di bak cuci piring). Semua komponen harus benar-benar kering sebelum dirakit kembali dengan urutan sebaliknya.

利用 BRUSHROLLCLEAN™ 功能清潔滾刷* / การทำความสะอาดแปรงลูกกลิ้งที่มีฟังก์ชัน BRUSHROLLCLEAN™* /
Membersihkan rol sikat dengan fungsi BRUSHROLLCLEAN™*

如果滾刷、軟管及轉輪被堵住或卡住，則需要進行清理。部分型號的 Ergorapido 機型配備了 BRUSHROLLCLEAN™ – 吸頭滾刷清潔功能，能輕鬆協助您保持刷子的清潔。

請注意，BRUSHROLLCLEAN™ 功能可能無法除去卡在滾刷中較粗的線頭、電線或粗的地毯纖維。

建議每週使用這個功能一次。
若要得到最佳效果，請在 Ergorapido 完全充電時使用 BRUSHROLLCLEAN™ 功能。

อาจจะต้องทำความสะอาดแปรงลูกกลิ้ง ท่อดูด และล้อ หากเกิดการอุดตันหรือติดขัดไม่ว่าจะด้วยสาเหตุใดก็ตาม เครื่องดูดฝุ่น Ergorapido บางรุ่นประกอบด้วย BRUSHROLLCLEAN™ – ฟังก์ชันการทำความสะอาดแปรง ที่ช่วยดูแลรักษาแปรงให้สะอาดได้อย่างง่ายดาย โปรดทราบว่าฟังก์ชัน BRUSHROLLCLEAN™ อาจไม่สามารถขจัดด้ายหนาๆ เส้นผม หรือเส้นใยพรมหนาๆ ที่ติดอยู่ในแปรงลูกกลิ้ง ขอแนะนำให้ใช้ฟังก์ชันนี้สัปดาห์ละครั้ง เพื่อให้ได้ผลลัพธ์ที่ดีที่สุด ให้ใช้ฟังก์ชัน BRUSHROLLCLEAN™ เมื่อ Ergorapido ชาร์จไฟจนเต็ม

Rol sikat, selang dan roda perlu dibersihkan apabila tiba-tiba macet atau tersumbat dan tidak dapat bergerak.

Beberapa model Ergorapido dilengkapi dengan BRUSHROLLCLEAN™ – suatu fungsi untuk membersihkan sikat yang membantu dan mempermudah pembersihan sikat. Ingat, fungsi BRUSHROLLCLEAN™ mungkin tidak dapat membersihkan benang atau kawat yang tebal, dan serat karpet yang tebal yang tersangkut di rol sikat.

Anda disarankan untuk menggunakan fungsi ini sekali seminggu.

Untuk hasil terbaik, gunakan fungsi BRUSHROLLCLEAN™ apabila isi daya Ergorapido penuh.

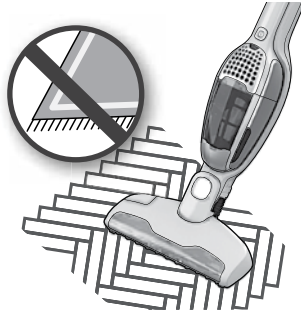

1. 確保吸塵器是開啟的，且站立於平坦的堅硬表面上。不可在厚的地毯或長毛線地毯上使用 BRUSHROLLCLEAN™ 功能。

1. ตรวจสอบให้แน่ใจว่าเครื่องดูดฝุ่นเปิดสวิตช์แล้วและตั้งวางไว้บนพื้นผิวที่แข็งและราบเรียบ อย่าใช้ฟังก์ชัน BRUSHROLLCLEAN™ บนพรมที่หนานุ่มหรือพรมขนยาว

1. Pastikan penyedot debu dihidupkan dan diletakkan di atas pada permukaan yang kuat dan rata Jangan menggunakan fungsi BRUSHROLLCLEAN™ pada karpet yang tebal atau permadani dengan benang yang panjang.



2. 當吸塵器開啟時，用您的腳踩下 BRUSHROLLCLEAN™ 按鈕。踩住大約5秒，或直到已移除所有的灰塵及毛髮為止，即可放開鈕。在使用 BRUSHROLLCLEAN™ 過程中，聲響的音量會增大，這屬於正常現象。

2. กดปุ่ม BRUSHROLLCLEAN™ ด้วยเท้าของท่าน ขณะที่เครื่องดูดฝุ่นเปิดสวิตช์อยู่ กดค้างไว้ประมาณ 5 วินาที หรือจนกว่าฝุ่นผงและเส้นผมทั้งหมดจะถูก ขจัดออกไป กดปุ่มคลายลอค ระหว่างการใช้งาน BRUSHROLLCLEAN™ เสียงของเครื่องจะดังขึ้นซึ่งเป็นเรื่องปกติ

2. Tekan tombol BRUSHROLLCLEAN™ dengan kaki saat penyedot debu dihidupkan. Tahan selama sekitar 5 detik atau hingga semua kotoran dan rambut dibersihkan. Lepaskan tombol. Selama tombol BRUSHROLLCLEAN™ digunakan akan terdengar suara yang lebih tinggi, dan ini normal.

利用 BRUSHROLLCLEAN™ 功能清潔滾刷* / การทำความสะอาดแปรงลูกกลิ้งที่มีฟังก์ชัน BRUSHROLLCLEAN™* /

Membersihkan rol sikat dengan fungsi BRUSHROLLCLEAN™*

此 BRUSHROLLCLEAN™ 功能具備過熱保護功能。如果 BRUSHROLLCLEAN™ 功能在單一放電期間內已被啟用超過 30 秒 (不論是持續或斷斷續續的累計)，滾刷將停止工作。

ฟังก์ชัน BRUSHROLLCLEAN™ ประกอบด้วยการป้องกันความร้อนสูงเกิน โดยจะปิดการใช้งานแปรงลูกกลิ้งหากว่าฟังก์ชัน BRUSHROLLCLEAN™ ถูกเปิดใช้งานนานเกินกว่า 30 วินาที (ต่อเนื่องหรือมีการขัดจังหวะ) ภายในหนึ่งช่วงเวลาหลังการชาร์จ

Fungsi BRUSHROLLCLEAN™ dilengkapi dengan perlindungan dari kepanasan. Fungsi ini akan menonaktifkan rol sikat jika fungsi BRUSHROLLCLEAN™ telah diaktifkan selama lebih dari 30 detik (terus-menerus atau jeda) dalam satu kali periode pemakaian.

1. Ergorapido Plus:

如果按下 BRUSHROLLCLEAN™ 按鈕時刷子停止轉動，吸頭前燈關閉且電池指示燈閃紅色與藍色光，請放開 BRUSHROLLCLEAN™ 按鈕。

1. Ergorapido plus:

ขณะที่กดปุ่ม BRUSHROLLCLEAN™ ดังไว้ หากแปรงหยุดหมุน ไฟที่ด้านหน้าหัวดูดดับลง และไฟสัญญาณแบตเตอรี่กะพริบเป็นสีแดงและฟ้า ให้ปล่อยปุ่ม BRUSHROLLCLEAN™

1. Ergorapido plus:

Apabila - saat menekan terus tombol BRUSHROLLCLEAN™ – sikat berhenti berputar, lampu depan nosel mati, dan lampu indikator baterai berkedip merah dan biru, lepaskan tombol BRUSHROLLCLEAN™ .

2. Ergorapido:

如果按下 BRUSHROLLCLEAN™ 按鈕時刷子停止旋轉，且吸頭前燈關閉，請放開 BRUSHROLLCLEAN™ 按鈕。

2. Ergorapido:

ขณะที่กดปุ่ม BRUSHROLLCLEAN™ ดังไว้ หากแปรงหยุดหมุนและไฟที่ด้านหน้าหัวดูดดับลง ให้ปล่อยปุ่ม BRUSHROLLCLEAN™

2. Ergorapido:

Apabila - saat menekan terus tombol BRUSHROLLCLEAN™ – sikat berhenti berputar dan lampu depan nosel mati, lepaskan tombol BRUSHROLLCLEAN™ .

放開按鈕後，刷子會開始旋轉，吸頭前燈會再次亮起。您可以照常繼續使用 Ergorapido。此時 BRUSHROLLCLEAN™ 功能將保持停用的狀態。若要重新啟用此功能，必須讓 Ergorapido 在充電座中持續充電至少 10 分鐘。

เมื่อปุ่มถูกปล่อย แปรงจะหมุนและไฟที่ด้านหน้าหัวดูดติดสว่างอีกครั้ง ท่านสามารถใช้งาน Ergorapido เพื่อดูดฝุ่นได้ตามปกติ ฟังก์ชัน BRUSHROLLCLEAN™ จะถูกปิดการใช้งาน ในการรีเซ็ต จะต้องชาร์จไฟ Ergorapido อย่างต่อเนื่องเป็นเวลาอย่างน้อย 10 นาทีในแท่นชาร์จ

Saat tombol dilepaskan, sikat akan berputar dan lampu depan nosel akan hidup lagi. Anda dapat terus menggunakan Ergorapido untuk menyedot debu seperti biasa. Fungsi BRUSHROLLCLEAN™ akan tetap dinonaktifkan. Untuk mereset, Ergorapido harus terus diisi daya selama minimal 10 menit di dudukan pengisian daya.

* ZB2932, ZB2933, ZB2934, ZB2935, ZB2941, ZB2942, ZB2943

清潔滾刷 / การทำความสะอาดแปรงลูกกลิ้ง / Membersihkan rol sikat

為了移除更粗的線頭或電線，以及在沒有配備 BRUSHROLLCLEAN™ 的機型上清理滾刷，應依照下列指示清理刷子

เพื่อขจัดเศษวัสดุชิ้นใหญ่หรือเส้นผม รวมถึงรุ่นที่ไม่มี BRUSHROLLCLEAN™ ควรจะทำความสะอาดแปรงตามขั้นตอนต่อไปนี้

Untuk melepaskan benang yang tebal atau kabel serta pada model yang tidak dilengkapi dengan BRUSHROLLCLEAN™, sikat harus dibersihkan sesuai dengan petunjuk berikut ini.

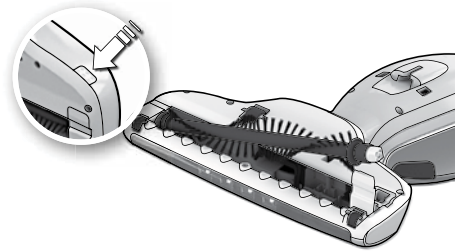

1. 首先關閉 Ergorapido 電源。按下滾刷釋放按鈕。這時滾刷蓋會稍微鬆開，方便您拆下滾刷。

1. **ขั้นแรก ให้ปิด Ergorapido** กดปุ่มปลดปล่อยแปรงลูกกลิ้ง ฝาจะเผยออกเล็กน้อย และจะสามารถถอดแปรงลูกกลิ้งออกได้

1. **Matikan Ergorapido terlebih dulu.** Tekan tombol pelepas rol sikat. Tutupny akan sedikit terbuka dan rol sikat dapat dilepaskan.

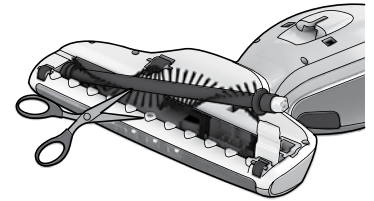

2. 把滾刷取出清理。使用尖銳物體來清除線頭。重新組裝滾刷，並確定可以自由滾動。蓋上滾刷蓋。

2. **ยกแปรงลูกกลิ้งออกและทำความสะอาด** ใช้วัตถุแหลมคมเพื่อเขี่ยเศษวัสดุออก ติดตั้งลูกกลิ้งกลับเข้าที่ตามเดิม และตรวจสอบว่าลูกกลิ้งสามารถหมุนอย่างอิสระ ปิดฝา

2. **Lepaskan rol sikat kemudian bersihkan.** Gunakan benda yang tajam untuk melepaskan benang. Pasang kembali sikat, pastikan sikat dapat berputar dengan lancar. Tutup kembali.

清潔軟管與轉輪 / การทำความสะอาดท่อดูดและล้อ / Membersihkan selang dan roda

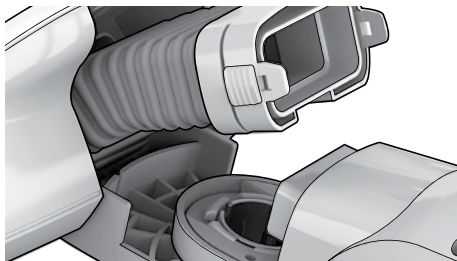

1. 鬆開門扣，然後把軟管拉出連接裝置。清除碎屑。放回軟管，並使用門扣鎖緊。

1. **คลายตัวยึด** และดึงท่อออกจากส่วนยึดติด เอาเศษผงออก เสียบท่อกลับเข้าที่ และล็อกโดยใช้ตัวยึด

1. **Kendurkan gesper** dan tarik selang dari pengaitnya. Bersihkan kotoran yang ada. Pasang kembali selang, kunci gespernya.

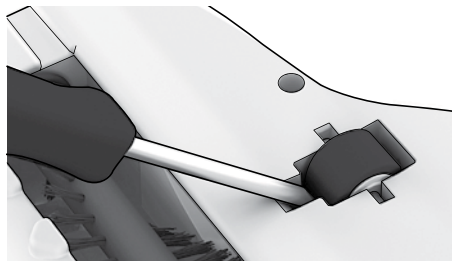

2. 如果要清潔轉輪，用小型螺絲起子小心地將其取出。

2. **หากจำเป็นต้องทำความสะอาดล้อ** ให้ถอดล้อออกอย่างระมัดระวัง โดยใช้ไขควงขนาดเล็ก

2. **Apabila roda perlu dibersihkan,** congkel dengan hati-hati menggunakan obeng kecil.



3. 除去任何可能會卡在轉輪轉軸上的物品。以按壓方式將其壓回軌道上，將轉輪重新組回。

3. **ขจัดวัตถุที่อาจติดค้างอยู่** ในเพลาล้อ ติดตั้งล้อกลับเข้าที่ตามเดิม โดยดันเข้าไปในร่อง

3. **Bersihkan benda-benda yang menyumbat** di dalam poros roda. Pasang kembali roda dengan menekannya ke wadahnya.

移除電池 / การถอดแบตเตอรี่ / Mengeluarkan baterai

在要報廢此吸塵器時，電池處理不當可能會造成危險。請將完整的手持式裝置送至回收站進行處理。在拆卸或回收電器用品時，請務必拆除電池。請勿將用過的電池與家用廢棄物一起處理。

การจัดการแบตเตอรี่อย่างไม่เหมาะสมอาจก่อให้เกิดอันตราย ให้ส่งคืนชุดพกพาทั้งหมดไปยังศูนย์รีไซเคิล โดยจะต้องถอดแบตเตอรี่ออกจากอุปกรณ์ก่อนที่จะกำจัดหรือรีไซเคิล
อย่าทิ้งแบตเตอรี่ใช้แล้วรวมกับขยะในครัวเรือน

Penanganan baterai yang tidak benar dapat membahayakan. Bawa unit genggam lengkap ke lokasi daur ulang. Baterai harus dikeluarkan sebelum alat dihancurkan atau didaur ulang.
Jangan membuang baterai bekas bersama dengan limbah rumah tangga.

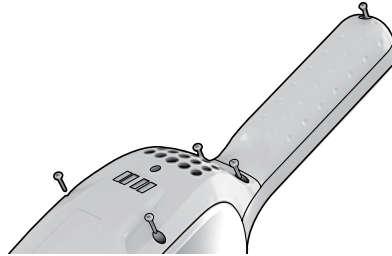

1. 拆除電池之前，請務必確認電池電量已完全用盡。拆除電池時，必須將 Ergorapido 從充電座卸下。鬆開螺絲。小心取下蓋子。
1. จะต้องคายประจุไฟออกจากแบตเตอรี่จนหมดก่อนที่จะถอดออก **ต้องถอด Ergorapido ออกจากที่ชาร์จก่อนที่จะถอดแบตเตอรี่** คลายสกรู ค่อยๆ ยกฝาขึ้น
1. Baterai harus dipakai sampai habis sebelum dibuang. **Egorapido harus dicabut dari stasiun pengisian daya apabila baterai akan dikeluarkan.** Kendorkan sekrup. Lepaskan tutupnya perlahan-lahan.

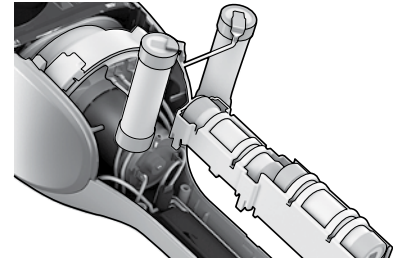

2. 拔下電線、拆下電池，然後在看得到的金屬部位貼上膠帶。將電池妥善的包裝好。
** 請只有在要報廢此吸塵器時，才拆除其電池。
2. **ถอดสายเชื่อมต่อ ถอดแบตเตอรี่ ติดเทปไว้บน** ส่วนที่เป็นโลหะและเห็นได้ชัดเจน ใส่แบตเตอรี่ไว้ในที่บ่มบรรจุที่เหมาะสม
2. **Potong kabel sambungan,** keluarkan baterai, lapiasi bagian logam yang terlihat dengan selotip. Masukkan baterai ke kemasan yang sesuai.

安全注意事項

Ergorapido 僅能由成人操作使用，而且僅適用於居家環境的一般吸塵打掃。請確定將吸塵器存放在乾燥處。所有服務與維修都必須經由 Electrolux 的授權服務中心處理。

本電器不適合身體、精神不健全或心智能力不成熟的人（包括幼童）使用，而且不具備本電器使用經驗或知識的人，也必須在有人負責其安全並提供監督或指示的情況下，方可使用本電器。

要清理或維護本電器之前，請先將插頭從插座拔除。

請小心看管幼童，以免他們把電器用品當作玩具。

請勿讓幼童任意拿到塑膠袋之類包裝材料，避免窒息危險。

每台吸塵器都設計使用特定的電壓。請檢查您的電源電壓是否和充電變壓器銘版上標示的額定電壓相同。只能使用針對這型產品設計的原廠電源供應器。

切勿於下列情況使用吸塵器：

- 在潮濕的環境中。
- 靠近可燃氣體等
- 外殼有明顯的損壞跡象。
- 在尖銳的物品或流體上。
- 有高溫或低溫的灰燼、點燃的煙蒂等。
- 有大量粉塵，例如來自石膏、混凝土、粉末、高溫或低溫的灰燼。

- 不要讓吸塵器直接被陽光照射。
- 避免讓吸塵器或電池接觸劇熱。
- 不得分解電池、使其短路、放在金屬表面上或接觸劇熱。
- 尚未裝上濾網前請勿使用吸塵器。
- 當吸塵器開啟且滾刷正在轉動時，不要嘗試觸摸滾刷。

在上述情形中使用吸塵器可能造成產品的嚴重損壞。這類損壞不在保固範圍內。

มาตรการด้านความปลอดภัย

Ergorapido ควรใช้โดยผู้ใหญ่เท่านั้นและใช้สำหรับกำจัดฝุ่นในบ้านเรือนตามปกติเท่านั้น ตรวจสอบให้แน่ใจว่าเครื่องดูดฝุ่นถูกเก็บไว้ในที่แห้ง การบริการและการซ่อมแซมทั้งหมดจะต้องดำเนินการโดยศูนย์บริการของ Electrolux

อุปกรณ์นี้ไม่ได้ออกแบบมา สำหรับการใช้งานโดยผู้ใหญ่ (และเด็ก) ที่มีความบกพร่อง ทางร่างกาย ทางประสาทรับรู้ หรือทางจิตใจ รวมถึงผู้ที่มีความบกพร่อง และความรู้ เว้นแต่จะมีผู้ดูแล หรือมีผู้ให้คำแนะนำ ในการใช้อุปกรณ์อย่างปลอดภัย

ให้ถอดปลั๊กออกจากเต้ารับไฟฟ้าก่อนที่จะทำความสะอาดหรือบำรุงรักษาอุปกรณ์

เด็กควรมีผู้ดูแล ในการใช้งาน เพื่อให้แน่ใจว่า จะไม่เล่นกับเครื่อง

วัสดุบรรจุภัณฑ์ เช่น ถุงพลาสติก ควรเก็บไว้ให้พ้นมือเด็ก เพราะอาจทำให้หายใจไม่ออกได้

เครื่องดูดฝุ่นแต่ละเครื่องได้รับการออกแบบเพื่อใช้แรงดันไฟฟ้าที่เฉพาะเจาะจง ตรวจสอบว่าแรงดันไฟฟ้าที่จ่ายเข้าตรงกับที่ระบุไว้บนแผ่นป้ายบอกกำลังไฟที่อะแดปเตอร์ชาร์จไฟ ใช้อะแดปเตอร์ชาร์จไฟดั้งเดิมซึ่งออกแบบมาเพื่อใช้ร่วมกับผลิตภัณฑ์รุ่นนี้เท่านั้น

ห้ามใช้เครื่องดูดฝุ่น:

- ในบริเวณที่เปียกชื้น
- ใกล้กับก๊าซไวไฟ ฯลฯ
- เมื่อตัวเครื่องมีร่องรอยชำรุดเสียหาย
- กับขงมีคมหรือของเหลว
- ดุดซีเตอร์หรือเย็บ ก้นหรือตัดไฟ ฯลฯ
- ดุดฝุ่นเนื้อละเอียด เช่น จากปูนปลาสเตอร์ คอนกรีต แป้ง ซีเตอร์หรือเย็บ

- อย่าวางเครื่องดูดฝุ่นไว้ในตำแหน่งที่โดนแสงแดดโดยตรง
- อย่าวางเครื่องดูดฝุ่นหรือแบตเตอรี่ไว้ใกล้กับแหล่งความร้อนสูง
- ห้ามถอดแยกแบตเตอรี่ ลัดวงจร วางไว้บนพื้นผิวโลหะ หรือวางไว้ใกล้กับแหล่งความร้อนสูง
- ห้ามใช้เครื่องดูดฝุ่นโดยปราศจากแผ่นกรองฝุ่น
- อย่าพยายามแกะแปรงลูกกลิ้งขณะที่เปิดสวิทช์เครื่องดูดฝุ่นและแปรงลูกกลิ้งกำลังหมุน

การใช้เครื่องดูดฝุ่นในสถานการณ์ข้างต้นอาจก่อให้เกิดความเสียหายอย่างรุนแรงต่อผลิตภัณฑ์ ความเสียหายดังกล่าวไม่อยู่ภายใต้การรับประกัน

Tindakan pencegahan demi keselamatan

Ergorapido sebaiknya hanya digunakan oleh orang dewasa dan untuk tujuan menyedot debu di lingkungan rumah tangga. Pastikan Anda menyimpan penyedot debu di tempat yang kering. Semua servis dan reparasi harus dilakukan oleh pusat servis resmi Electrolux.

Alat ini tidak ditujukan untuk digunakan oleh orang (termasuk anak-anak) yang memiliki keterbatasan kemampuan secara fisik, inderawi atau keterbelakangan mental, atau orang yang kurang berpengalaman dan kurang berpengetahuan, kecuali mereka telah mendapatkan pengarahannya atau petunjuk mengenai cara penggunaan oleh orang yang bertanggung jawab terhadap keselamatannya.

Cabut steker dari stopkontak sebelum membersihkan atau melakukan perawatan alat.

Anak-anak harus diawasi agar mereka tidak bermain dengan alat ini

Jauhkan bahan pengemas, misalnya kantong plastik dari jangkauan anak-anak untuk menghindari mati lemas.

Setiap penyedot debu didesain untuk digunakan pada voltase tertentu. Periksa apakah voltase listrik Anda sama dengan yang tercantum di pelat rating pada adaptor pengisi daya. Hanya gunakan adaptor pengisi daya asli yang khusus dirancang untuk model ini.

Jangan menggunakan penyedot debu:

- Di tempat yang basah.
- Di dekat gas yang mudah terbakar, dsb.
- Apabila rangkanya menunjukkan tanda-tanda kerusakan.
- Pada benda tajam atau cairan.
- Pada bara api atau arang bekas pembakaran, puntung rokok yang menyala, dsb.
- Untuk debu yang halus, misalnya debu gips, beton, tepung, abu panas atau dingin.
- Jangan meletakkan penyedot debu di bawah sinar matahari langsung.
- Hindarkan penyedot debu atau baterai dari panas yang berlebihan.
- Baterai tidak boleh dibongkar, dibuat sirkuit pendek, diletakkan di atas permukaan dari logam atau terpapar ke panas yang berlebihan.
- Jangan menggunakan penyedot debu tanpa memasang filternya.
- **Jangan berusaha menyentuh rol sikat saat alat dihidupkan dan saat rol sikat sedang berputar.**

Menggunakan penyedot debu dalam kondisi di atas dapat menyebabkan kerusakan yang serius pada produk. Kerusakan tersebut tidak dikover oleh garansi.

消費者資訊

服務與維修

故障或出問題時，您必須將 Ergorapido 交給 Electrolux 授權的服務中心處理。如果電源線或充電座損壞，必須交由 Electrolux、服務代理商或者同樣合格的人員更換，以免發生危險。

用戶須知

欲知詳情，請光臨我們的網站：
www.electrolux.com。

產品上  或其包裝上的標記表示不能把該產品作為家庭垃圾處理。應該將其送往電器與電子設備報廢的適當回收站點。透過正確棄置本產品，您也可以協助避免由於不適當處理廢品，而為環境和人類健康帶來潛在的負面影響。如需關於回收本品的更詳細資訊，請聯絡您當地的資源回收單位、環保局或清潔隊，或您購買產品的商店。

ข้อมูลผู้บริโภค

การบริการหรือซ่อมแซม

ในกรณีที่อุปกรณ์เสียหรือมีข้อบกพร่อง จะต้องนำ Ergorapido ไปยังศูนย์บริการของ Electrolux หากอุปกรณ์หรือสายไฟเสียหาย ให้ส่งซ่อมกับ Electrolux ตัวแทนให้บริการหรือบุคลากรผู้เชี่ยวชาญเพื่อป้องกันอันตรายที่อาจเกิดขึ้น

ข้อมูลสำหรับผู้บริโภค

ดูแนวคิดอื่นๆ ของเราได้ที่นี่ www.electrolux.com ข้อมูลสำหรับผู้บริโภค

สัญลักษณ์  ที่กำกับอยู่บนผลิตภัณฑ์ หรือบรรจุภัณฑ์ แสดงว่าท่านไม่สามารถทิ้งผลิตภัณฑ์ดังกล่าวรวมกับขยะในครัวเรือนได้ โดยให้นำไปจำหน่ายทิ้ง ณ จุดจัดเก็บที่เหมาะสมเพื่อทำการรีไซเคิลส่วนประกอบทางไฟฟ้าและอุปกรณ์อิเล็กทรอนิกส์ การจำหน่ายผลิตภัณฑ์ดังกล่าวทิ้งอย่างถูกวิธี เป็นการช่วยป้องกันผลกระทบที่อาจเกิดขึ้นต่อสภาพแวดล้อมและสุขภาพของมนุษย์ ซึ่งอาจเกิดขึ้นได้เนื่องจากการกำจัดเครื่องใช้เหลือทิ้งอย่างไม่ถูกวิธี สอบถามข้อมูลเพิ่มเติมเกี่ยวกับการรีไซเคิลผลิตภัณฑ์ได้จากหน่วยงานในพื้นที่ ผู้ให้บริการจัดเก็บขยะประจำพื้นที่ของท่าน หรือร้านที่จำหน่ายผลิตภัณฑ์นี้

Informasi bagi konsumen

Servis atau reparasi

Apabila alat rusak atau tidak dapat berfungsi, Ergorapido harus dibawa ke pusat servis resmi Electrolux. Jika kabel listrik atau alat pengisi daya rusak, penggantian hanya boleh dilakukan oleh Electrolux, agen servis atau orang yang memiliki kualifikasi serupa untuk menghindari bahaya.

Informasi tentang konsumen

Berbagi pemikiran kami lebih lanjut di www.electrolux.com

Simbol  pada produk ini atau kemasannya menandakan, bahwa produk ini tidak boleh diperlakukan sebagai limbah rumah tangga. Melainkan, produk ini harus diserahkan ke tempat pengumpulan limbah daur-ulang untuk perangkat listrik dan elektronik. Dengan memastikan, bahwa produk ini dibuang dengan cara yang benar, Anda akan membantu mencegah timbulnya konsekuensi negatif terhadap lingkungan dan kesehatan manusia, yang bisa muncul jika limbah produk ini tidak ditangani secara benar. Untuk rincian informasi mengenai daur ulang produk ini, hubungi kantor pemda setempat, layanan pembuangan limbah rumah tangga atau toko tempat Anda membeli produk ini.

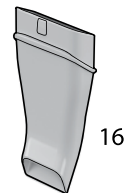
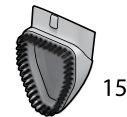
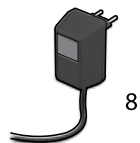
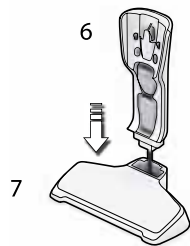
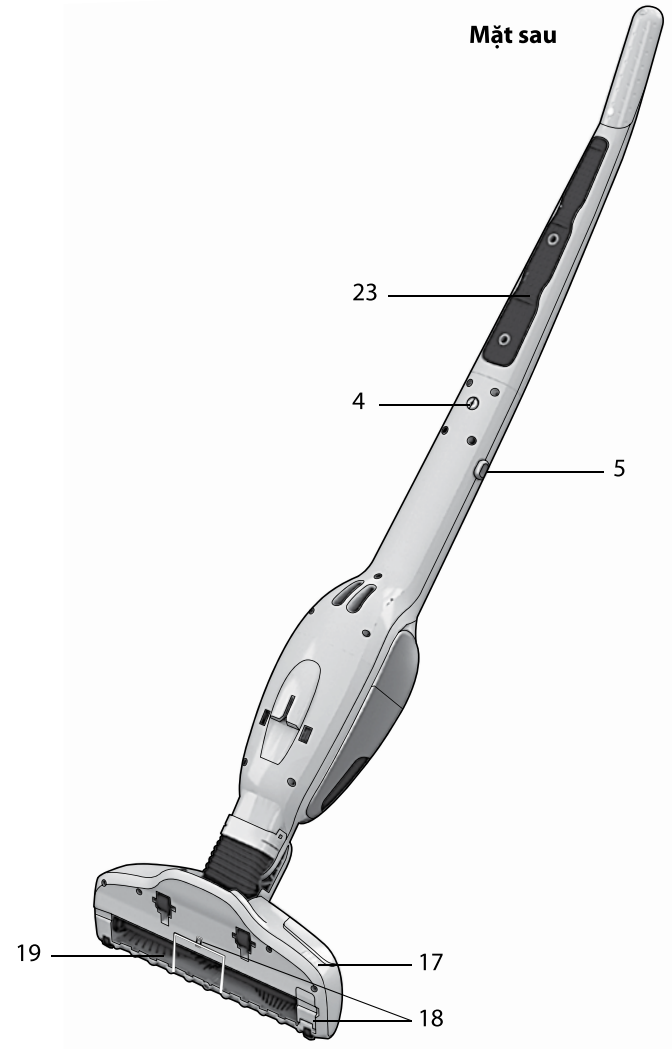
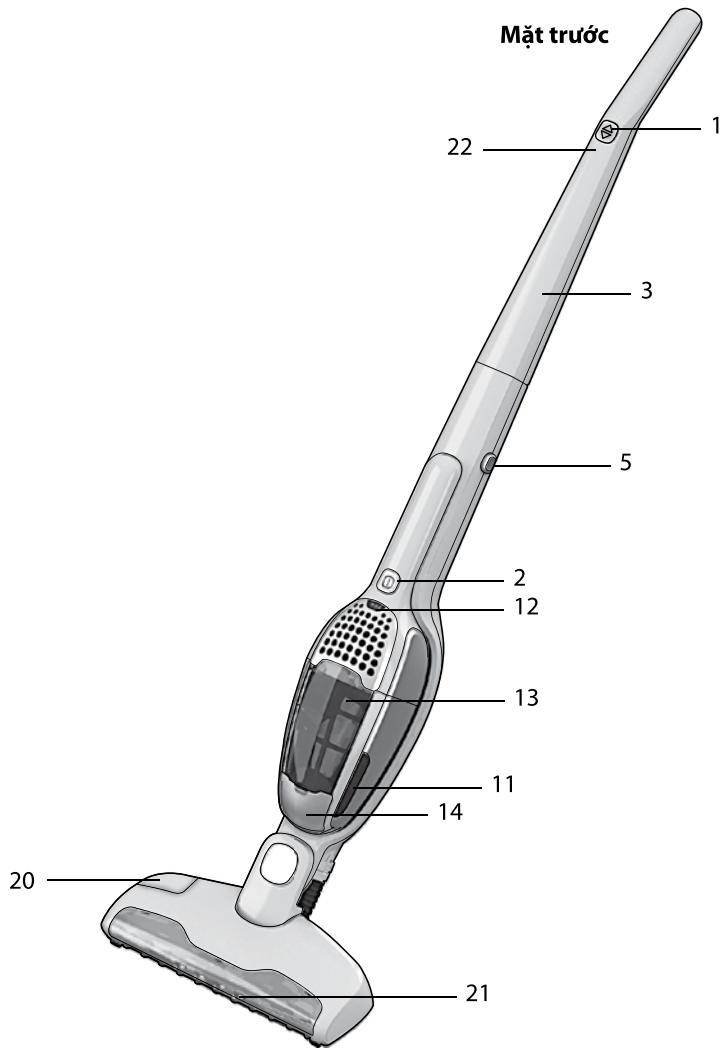

Tiếng Việt

Mục lục

Tháo bao bì và lắp ráp.....	28
Sạc pin	29
Hút bụi	30
Xả bụi và làm sạch	31
Làm sạch trực bàn chải, ống mềm và bánh xe.....	32
Tháo pin.....	35
Biện pháp an toàn	36
Thông tin người tiêu dùng	37

Tính năng/Phụ tùng

1 Nút bật/tắt
2 Nút bật/tắt, thiết bị cầm tay
3 Tay cầm
4 Đinh vít khóa
5 Nút nhà, thiết bị cầm tay
6 Bộ đế sạc, thiết bị treo tường
7 Bộ đế sạc, thiết bị đặt trên sàn
8 Bộ sạc điện
9 Bộ lọc tinh (bộ lọc bên trong)
10 Bộ lọc trước (bộ lọc bên ngoài)
11 Nút nhà, túi bụi
12 Màn hình hiển thị pin, kiểu Lithium*
13 Túi bụi
14 Nắp máy hút bụi
15 Bàn chải
16 Đầu hút khe
17 Nút nhà trực bàn chải*
18 Nắp đậy trực bàn chải*
19 Trực bàn chải
20 Nút BRUSHROLLCLEAN™ *
21 Đèn trước đầu hút
22 Chỉ báo đang sạc, kiểu NiMH*
23 Bảng hãm

* Chỉ dành cho một số kiểu máy

GB

KOR

CHS

CHT

THA

IND

VIE

Tháo bao bì và lắp ráp

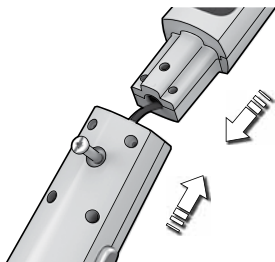

- 1. Kiểm tra xem mọi bộ phận đều có trong hộp hay chưa.** Điều chỉnh tay cầm bằng cách lắp cân thận vào phần thân dưới. Đảm bảo dây cáp không vướng.



- 2. Giữ chặt tay cầm** bằng cách siết chặt đinh ốc khóa được cung cấp. Dùng tua vít hoặc nôm.

Bộ đế sạc

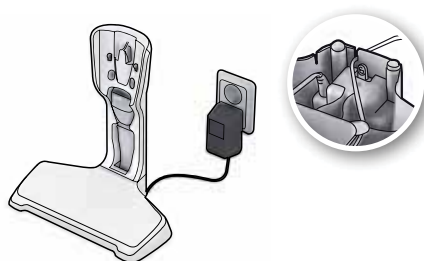

- 1. Đặt bộ đế sạc** cách thật xa nguồn nhiệt, ánh sáng mặt trời trực tiếp hoặc nơi ẩm ướt. Lắp bộ sạc vào nguồn chính và kết nối nó với bộ đế sạc.

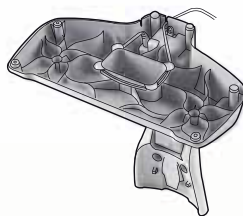

- 2. Ở đáy bộ đế sạc** có một chỗ lõm nơi dây cáp không dùng có thể được quấn lại.

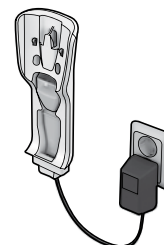

- 3. Thiết bị treo tường** cũng có thể được lắp trên tường. Tách riêng nó khỏi thiết bị đặt trên sàn. Luôn đảm bảo rằng tường có thể chịu được trọng lượng của Ergorapido.

Sạc pin

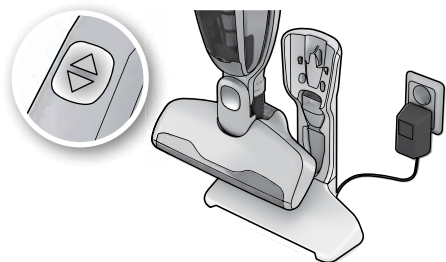

- 1. Ergorapido:** Đèn chỉ báo sẽ bật sáng ngay sau khi đặt Ergorapido ở vị trí chính xác trong bộ đế sạc. Khi sạc đầy, đèn LED sẽ bật lên vài giây trong một phút.

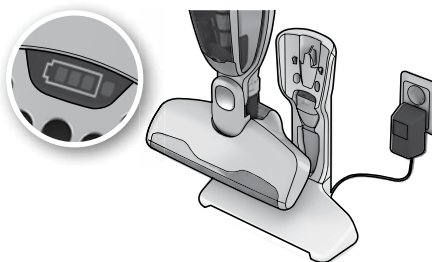

- 2. Ergorapido Plus:** Đèn hiển thị công suất pin sẽ thay nhau bật sáng khi thiết bị đang sạc sau khi đặt thiết bị ở vị trí chính xác trên bộ đế sạc.

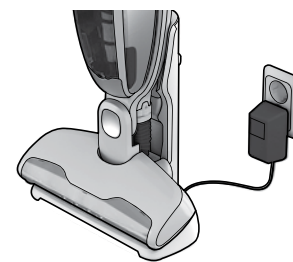

- 3. Khi pin hết hoàn toàn** cần phải sạc trong khoảng 16 giờ để có được lại công suất pin đầy đủ (4 giờ dành cho Ergorapido Plus). Để Ergorapido ở chế độ sạc khi không dùng để duy trì hiệu năng hoạt động của pin.

GB
KOR
CHSCHT
THA
IND

VIE

Màn hình hiển thị công suất pin*



- 1.** 3 đèn xanh: công suất pin >75%
2 đèn xanh: công suất pin 75-25%
1 đèn xanh: công suất pin <25%
1 đèn xanh nhấp nháy: công suất pin – hết



- 2. Nếu một đèn đỏ bật sáng:** Thiết bị quá nóng. Làm sạch bộ lọc, trục bàn chải, ống mềm và sạc điện.
3. Nếu 1 đèn đỏ nhấp nháy: Động cơ đang quá tải. Làm sạch trục bàn chải.



- 4. Khi được sạc đầy:** Đèn LED sẽ tắt và chuyển về chế độ dự phòng –điện năng tiêu thụ thấp hơn nhiều, được chỉ báo bằng một đèn nhấp nháy mỗi phút.
5. Nếu đèn đỏ và xanh nhấp nháy: vui lòng tham khảo trang 9.

Hút bụi trên sàn và thảm

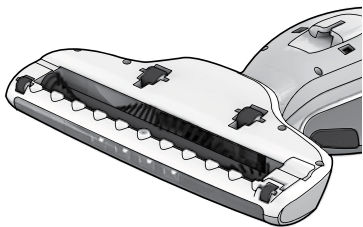

1. **Bạn cần thường xuyên kiểm tra để đảm bảo** rằng bánh xe đầu phun và trục bàn chải phải sạch sẽ để tránh làm trầy xước những sàn nhà dễ bị hỏng.

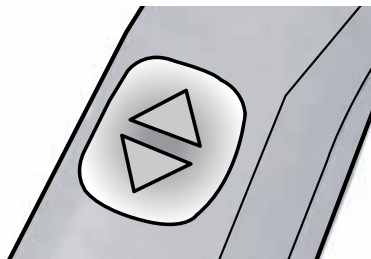

2. Khởi động Ergorapido bằng cách ấn nút bật/tắt.

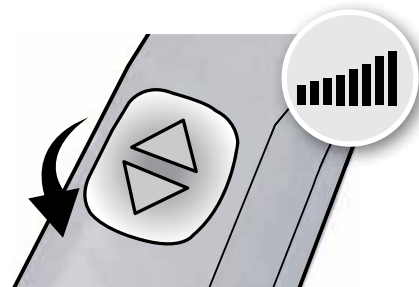

3. Điều chỉnh mức công suất bằng cách ấn vào phần dưới của nút bật/tắt.

Hút bụi trên đồ đạc, ghế xe hơi, v.v...

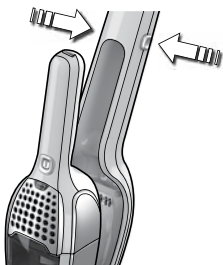

1. **Tháo rời thiết bị cầm tay bằng cách ấn các nút** nhả ra. Đầu hút khe và bàn chải nhỏ đều được cất giữ tại bộ để sạc.

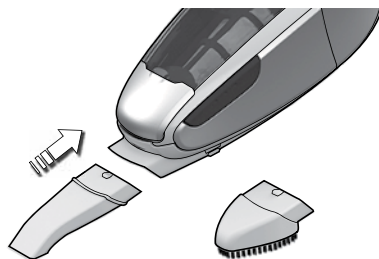

2. **Nổi đầu hút khe** để tạo điều kiện làm sạch những khu vực khó với tới hay nổi bàn chải để quét bụi.



3. Khởi động/Ngừng thiết bị cầm tay bằng cách ấn nút khởi động.

Xả bụi và làm sạch

Túi bụi của Ergorapido phải được xả bụi đều đặn và túi bụi và bộ lọc cần được làm sạch để duy trì sức hút mạnh.

Không bao giờ được giặt túi bụi hay bộ lọc trong máy rửa bát.

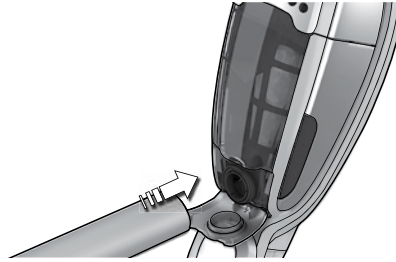

1. Xả bụi nhanh túi bụi. Mở nắp máy hút bụi. Làm sạch túi bụi bằng cách đặt ống mềm của máy hút bụi khác ở miệng.



2. Xả sạch túi bụi. Tháo bộ lọc ra, đổ hết những thứ trong bộ lọc vào thùng rác. Trả bộ lọc lại và ấn túi bụi trở lại vị trí.

GB
KOR
CHS

CHT
THA
IND

VIE

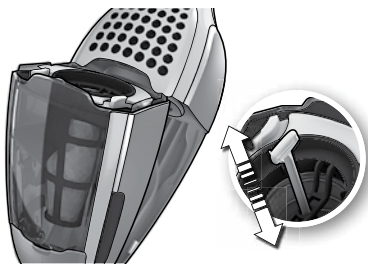

3. Làm sạch nhanh bộ lọc tinh. (Khuyến cáo làm sạch hàng ngày). Nhả túi bụi ra, kéo/nhả lò xo 5-6 lần để đổ hết bụi ra.



4a. Làm sạch túi bụi và bộ lọc.
(Khuyến cáo thực hiện vào mỗi lần làm sạch thứ 5). Nhả túi bụi ra, lấy ra cả hai bộ lọc bằng cách ấn nút nhỏ.



4b. Tách hai bộ lọc. Có thể lắc làm sạch hoặc giặt sạch túi bụi và bộ lọc bằng nước ấm (*không bao giờ bằng máy rửa bát*). Phải chắc chắn mọi bộ phận đều được để khô trước khi lắp lại ở vị trí theo trình tự ngược lại.

Làm sạch trục bàn chải bằng chức năng BRUSHROLLCLEAN™*

Trục bàn chải, ống mềm và bánh xe có thể cần phải được làm sạch nếu chúng bị chặn hay vướng vì bất cứ lý do gì.

Một số kiểu Ergorapido được trang bị với **BRUSHROLLCLEAN™** – một chức năng làm sạch bằng bàn chải, giúp duy trì bàn chải sạch một cách dễ dàng. Vui lòng lưu ý là chức năng **BRUSHROLLCLEAN™** có thể không có khả năng tháo hết các sợi dày, dây hay các sợi thảm dày mắc trong trục bàn chải. Khuyến cáo nên sử dụng chức năng này một lần một tuần.

Để đạt được kết quả tốt nhất, hãy sử dụng chức năng **BRUSHROLLCLEAN™** khi Ergorapido được sạc đầy.

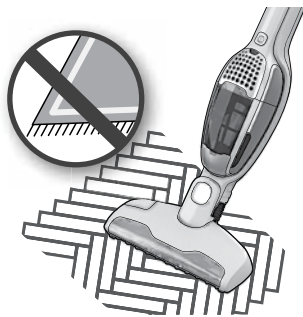

1. Đảm bảo máy hút bụi được bật lên và dựng đứng trên bề mặt cứng bằng phẳng. Không được dùng chức năng **BRUSHROLLCLEAN™** trên các thảm dày hay thảm trải sàn có lông dài.



2. Ấn nút **BRUSHROLLCLEAN™** bằng chân trong khi máy hút bụi được bật. Giữ nút này trong khoảng 5 giây hoặc đến khi gỡ bỏ hết mọi bụi bẩn và tóc. Nhả nút ra. Trong khi sử dụng **BRUSHROLLCLEAN™**, âm lượng sẽ tăng và điều này là bình thường.

Làm sạch trục bàn chải bằng chức năng BRUSHROLLCLEAN™*

Chức năng BRUSHROLLCLEAN™ được trang bị với bộ bảo vệ quá nhiệt. Thiết bị bảo vệ này sẽ tắt hoạt động trục bàn chải nếu chức năng BRUSHROLLCLEAN™ đã được kích hoạt trong hơn 30 giây (liên tục hoặc ngắt trong vòng một chu kỳ xả pin).

1. Ergorapido plus:

Trong khi đang giữ nút BRUSHROLLCLEAN™ ấn xuống, nếu bàn chải ngừng quay, các đèn trước đầu hút tắt và đèn chỉ báo pin nhấp nháy đỏ và xanh, thì hãy nhả nút BRUSHROLLCLEAN™ ra.

2. Ergorapido:

Trong khi đang giữ nút BRUSHROLLCLEAN™ ấn xuống, nếu bàn chải ngừng quay và đèn trước đầu phun tắt, thì hãy nhả nút BRUSHROLLCLEAN™ ra.

Khi nút được nhả ra, bàn chải sẽ quay và các đèn trước đầu hút sẽ bật lên lại. Bạn có thể tiếp tục sử dụng Ergorapido để hút bụi như thông thường. Chức năng BRUSHROLLCLEAN™ sẽ tiếp tục bị vô hiệu hóa. Để thiết lập lại, phải sạc Ergorapido liên tục ít nhất trong vòng 10 phút ở để sạc pin.

Làm sạch trục bàn chải

Để lấy hết các sợi dày hơn hoặc dây cũng như trên các kiểu máy không được trang bị BRUSHROLLCLEAN™, cần phải làm sạch trục bàn chải theo các hướng dẫn sau đây.

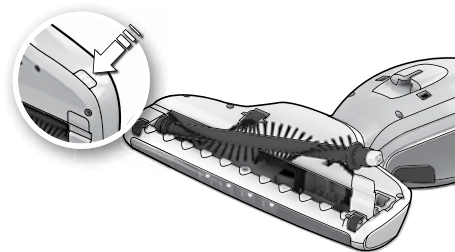

1. Trước tiên tắt Ergorapido. Ấn nút nhả trục bàn chải. Nắp đậy sẽ mở ra khá dễ dàng và trục bàn chải có thể được tháo ra.

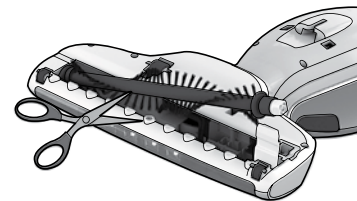

2. Rút trục bàn chải ra và làm sạch nó. Dùng một vật sắc để lấy hết các sợi chỉ. Lắp lại trục, đảm bảo nó có thể quay thoải mái. Đóng nắp đậy lại.

Làm sạch ống mềm và bánh xe

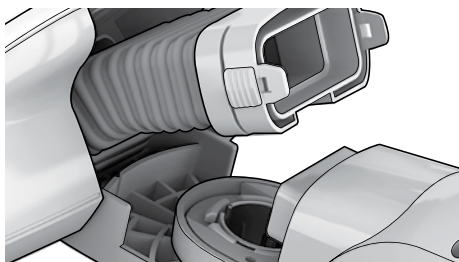

1. Nới lỏng chốt hãm và kéo ống mềm khỏi đầu nối. Gỡ hết các mảnh vụn. Đặt ống mềm trở lại, dùng chốt hãm khóa lại.

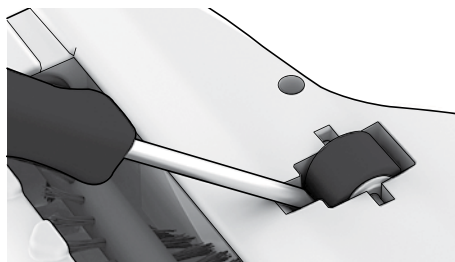

2. Nếu bánh xe cần làm sạch, tháo chúng ra một cách cẩn thận bằng cách dùng tua vít nhỏ.



3. Tháo các vật mà có thể đã bị vướng trong các trục bánh xe. Lắp lại bánh xe bằng cách ấn chúng vào lại rãnh.

Tháo pin

Nếu xử lý pin không đúng cách có thể gây nguy hiểm. Hãy trả toàn bộ thiết bị cầm tay về một trạm tái chế. Phải tháo pin ra khỏi thiết bị trước khi nó được đập vụn hay tái chế.

Không bao giờ vứt pin đã dùng cùng rác thải gia đình.

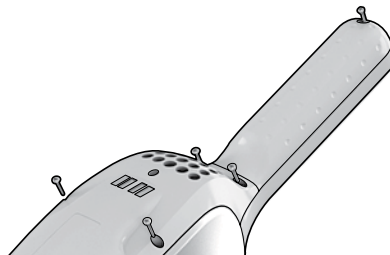

1. Phải luôn sử dụng hết sạch pin trước khi tháo. **Phải ngắt kết nối Ergorapido khỏi bộ để sạc khi tháo pin.** Tháo đinh vít. Nâng nắp đậy lên một cách cẩn thận.

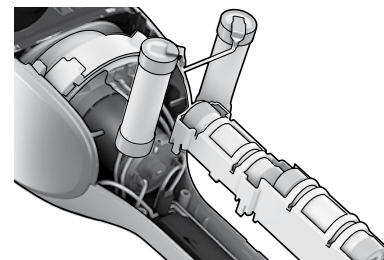

2. **Cắt dây cáp kết nối**, tháo pin ra, dán băng dính lên các vùng kim loại nhìn thấy được. Đặt pin vào trong bao gói thích hợp.

GB
KOR
CHS

CHT
THA
IND

VIE

Biện pháp an toàn

Chỉ có người trưởng thành mới được sử dụng Ergorapido và chỉ dành cho việc hút bụi thông thường trong môi trường trong nhà. Đảm bảo máy hút bụi được cất giữ ở nơi khô ráo. Mọi việc bảo dưỡng và sửa chữa phải do trung tâm dịch vụ được ủy quyền của Electrolux tiến hành.

Thiết bị này không được thiết kế để sử dụng bởi các cá nhân (kể cả trẻ em) có khuyết tật về thể chất, cảm giác hoặc thần kinh, hoặc thiếu kinh nghiệm và kiến thức, trừ phi họ được giám sát hoặc chỉ dẫn sử dụng thiết bị bởi một người chịu trách nhiệm về sự an toàn của họ.

Hãy tháo phích cắm khỏi ổ cắm trước khi lau dọn hay bảo dưỡng thiết bị.

Trẻ em phải được giám sát để đảm bảo chúng không nghịch phá thiết bị này.

Các vật liệu bao bì, như túi nhựa, không được để tiếp xúc với trẻ em để tránh trường hợp ngạt thở.

Tùng máy hút bụi được thiết kế cho một điện áp cụ thể. Kiểm tra xem điện áp cung cấp của bạn có giống như đã ghi trên nhãn máy trên bộ sạc điện hay chưa. Chỉ sử dụng bộ sạc điện chính hãng được thiết kế cho kiểu máy này.

Không bao giờ sử dụng máy hút bụi:

- Ở những khu vực ẩm ướt.
 - Ở gần sát các chất khí dễ cháy, v.v...
 - Khi vỏ máy có những dấu hiệu hư hại có thể nhìn thấy được.
 - Trên các vật sắc hoặc chất lỏng.
 - Trên than xỉ nóng hoặc lạnh, mẫu thuốc lá đã cháy, v.v...
 - Trên bụi mịn, chẳng hạn như từ thạch cao, bê tông, bột, tro nóng hoặc lạnh.
-
- Không được để máy hút bụi dưới ánh sáng mặt trời trực tiếp.
 - Tránh để máy hút bụi hay pin tiếp xúc với nhiệt mạnh.
 - Không được tháo dỡ, làm đoạn mạch pin, hay đặt pin dựa vào một bề mặt kim loại hay để pin tiếp xúc với nhiệt mạnh.
 - Không bao giờ sử dụng máy hút bụi mà không có bộ lọc của nó.
 - **Không được cố chạm vào trục bàn chải trong khi bật máy hút bụi và khi trục bàn chải đang quay.**

Việc sử dụng máy hút bụi trong các trường hợp trên có thể làm hư hỏng nghiêm trọng sản phẩm. Những hư hỏng như vậy không nằm trong chế độ bảo hành.

Thông tin người tiêu dùng

Bảo dưỡng hoặc sửa chữa

Trong trường hợp trục trặc hay hỏng hóc, phải mang Ergorapido của bạn đến một trung tâm dịch vụ được ủy quyền của Electrolux. Nếu dây cáp nguồn hay bộ sạc bị hư hại, nó phải được thay thế bởi Electrolux hoặc đại lý dịch vụ của Electrolux hoặc một người có đủ trình độ tương đương để tránh nguy hiểm.

Thông tin cho người tiêu dùng

Hãy đóng góp thêm ý kiến trên www.electrolux.com



Biểu tượng  trên sản phẩm hoặc bao bì của nó cho biết rằng không được xử lý sản phẩm này như rác thải gia đình. Thay vào đó, phải chuyển thiết bị đến điểm thu gom áp dụng để tái chế thiết bị điện và điện tử. Khi đảm bảo vứt bỏ đúng cách sản phẩm này, bạn sẽ giúp phòng tránh những hậu quả tiêu cực có thể có đối với môi trường và sức khỏe con người, là những hậu quả do việc xử lý rác thải không đúng cách đối với sản phẩm này. Để biết thêm thông tin chi tiết về việc tái chế sản phẩm này, vui lòng liên hệ văn phòng thành phố địa phương của bạn, cơ quan phụ trách vứt bỏ rác thải gia đình hoặc cửa hàng nơi bạn đã mua sản phẩm.

GB
KOR
CHSCHT
THA
IND

VIE

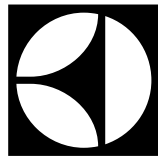

Thinking of you
Electrolux