



ultrapower™

21,6V
25,2V

EN	Vacuum cleaner	User manual
KR	진공 청소기	사용자 설명서
IND	Pengisap debu	Buku petunjuk penggunaan
CH	吸尘器	用户手册
TH	เครื่องดูดฝุ่น	คู่มือผู้ใช้
TW	吸塵器	使用指南
VIET	Máy hút bụi	Tài liệu hướng dẫn sử dụng



Thank you for choosing an Electrolux ULTRAPOWER vacuum cleaner. ULTRAPOWER is a cordless stick vacuum cleaner intended for indoor use on light dry household dust and debris. In order to ensure the best results, always use original Electrolux accessories and spare parts. They have been designed especially for your vacuum cleaner.

Electrolux ULTRAPOWER 진공 청소기를 구입해 주셔서 감사합니다. ULTRAPOWER는 가정용 무선 스틱형 진공 청소기로써 강력하고 편리하게 먼지와 부스러기를 제거하는 데 사용할 수 있습니다. 최적의 제품 사용 성능을 위해서는 항상 정품 Electrolux 부속품 및 예비 부품을 사용하시기 바랍니다. 정품 Electrolux 부속품은 Electrolux 진공 청소기에 맞춰 설계되었습니다.

Terima kasih Anda telah memilih pengisap debu Electrolux ULTRAPOWER. ULTRAPOWER adalah stik pengisap debu tanpa kabel untuk membersihkan debu dan kotoran ringan di dalam ruangan. Untuk memastikan hasil terbaik, selalu gunakan aksesoris dan suku cadang Electrolux yang asli. Aksesoris tersebut khusus dirancang untuk pengisap debu Anda.

感谢您选择伊莱克斯 ULTRAPOWER 吸尘器。ULTRAPOWER 是一种无绳立式吸尘器，用于清洁室内轻度干燥的日常灰尘和碎屑。为确保获得最佳的清洁效果，请使用原装伊莱克斯配件和备件。这些配件专为您的吸尘器设计。

ขอขอบคุณที่เลือกใช้เครื่องดูดฝุ่น Electrolux ULTRAPOWER ULTRAPOWER เป็นเครื่องดูดฝุ่นตามแบบไร้สายสำหรับใช้ภายในอาคารเพื่อดูดฝุ่นและผงแห้งเท่านั้น เพื่อให้ประสิทธิภาพการทำงานสูงสุด ให้ใช้อุปกรณ์เสริมและอะไหล่แท้ของ Electrolux ทุกครั้ง เนื่องจากอุปกรณ์เหล่านี้ออกแบบมาสำหรับเครื่องดูดฝุ่นของคุณโดยเฉพาะ

感謝您選購 Electrolux ULTRAPOWER 吸塵器。ULTRAPOWER 為一款無線長棍型吸塵器，可用來清除家中室內較輕的乾燥灰塵與碎屑。為了確保達到最佳效果，請務必使用 Electrolux 原廠配件與備用零件。配件都是特別針對吸塵器而設計的。

Cảm ơn quý vị đã chọn máy hút bụi Electrolux ULTRAPOWER. ULTRAPOWER là máy hút bụi dạng cây không dây để sử dụng trong nhà và máy này dùng để hút bụi và mảnh vụn khô nhẹ trong gia đình. Để đảm bảo đạt kết quả tốt nhất, luôn sử dụng phụ tùng và phụ kiện Electrolux chính hãng. Chúng được thiết kế dành riêng cho máy hút bụi.

BEFORE STARTING

- Check that the package includes all parts described in this ULTRAPOWER instruction manual
- Read this instruction manual carefully.
- Pay special attention to the safety precautions chapter.

TABLE OF CONTENTS

Safety precautions	3
Unpacking and charging	12
Cleaning the filters and dust container	20
Cleaning brush roll, wheels and hose	24
Removing the battery pack	31
Consumer information	35

EN

Enjoy your Electrolux ULTRAPOWER!

KR

IND

사용 전

- 본 ULTRAPOWER 사용 설명서에 명시된 모든 부품이 제품 패키지에 포함되어 있는지 확인하십시오.
- 본 사용 설명서를 자세히 읽어 보시기 바랍니다.
- 안전 주의사항은 좀 더 주의 깊게 읽어 보시기 바랍니다.

CH

목차

안전주의사항	4
포장 풀기 및 충전	12
필터 및 먼지통 청소	20
브러쉬 롤, 바퀴 및 호스 청소	24
배터리 팩 제거	31
소비자 정보	35

TH

VIET

Electrolux ULTRAPOWER로 자유로운 무선 라이프를 시작하세요!

SEBELUM PENGGUNAAN

- Periksa kelengkapan paket penjualan yang terdiri dari semua komponen yang disebutkan pada buku petunjuk ULTRAPOWER ini
- Bacalah buku petunjuk ini dengan seksama.
- Khususnya bab tindakan pencegahan demi keselamatan.

DAFTAR ISI

Tindakan pencegahan demi keselamatan.....	5
Membuka kemasan dan mengisi daya.....	12
Membersihkan saringan dan kantong debu.....	20
Membersihkan rol sikat, roda, dan selang.....	24
Melepaskan baterai.....	32
Informasi bagi konsumen.....	35

Selamat menggunakan Electrolux ULTRAPOWER Anda!

准备工作

- 检查包装中是否包含本 ULTRAPOWER 说明手册中所述的所有部件。
- 仔细阅读本说明手册。
- 应特别注意“安全预防措施”一章。

目录

安全预防措施	6
拆除包装及充电	12
清洁过滤器和集尘盒	20
清洁刷辊、滚轮和软管	24
拆下电池组	32
用户须知	35

享受伊莱克斯 ULTRAPOWER 的优越清洁性能!

ก่อนเริ่มใช้งาน

- ตรวจสอบอุปกรณ์ภายในกล่องว่าครบถ้วนตามที่แจ้งในคู่มือของ ULTRAPOWER
- อ่านรายละเอียดในคู่มือชุดนี้โดยละเอียด
- ปฏิบัติตามหมายเหตุด้านความปลอดภัยอย่างเคร่งครัด

สารบัญ

มาตรการด้านความปลอดภัย.....	7
การแกะกล่องและชาร์จเครื่อง.....	12
การทำความสะอาดตัวกรองและที่เก็บฝุ่น.....	20
การทำความสะอาดแปรงลูกกลิ้งล้อและท่อดูด.....	24
การถอดแบตเตอรี่.....	33
ข้อมูลผู้บริโภค.....	36

ขอให้สนุกกับการใช้ Electrolux ULTRAPOWER!

開始使用之前

- 請檢查產品包裝是否含有本 ULTRAPOWER 說明書中所提到的全部零件
- 請仔細閱讀本說明手冊。
- 請特別注意安全防範措施一章。

目錄

安全防範措施	8
打開包裝與充電	12
清潔濾網及集塵容器	20
清潔刷棍、轉輪與軟管	24
取下電池組	33
消費者資訊	36

享用 Electrolux ULTRAPOWER 的絕佳功能!

TRƯỚC KHI BẮT ĐẦU

- Kiểm tra đảm bảo rằng bao bì đóng gói gồm có tất cả các bộ phận nêu trong tài liệu hướng dẫn về sản phẩm ULTRAPOWER này
- Hãy đọc kỹ tài liệu hướng dẫn này.
- Đặc biệt chú ý đến chương về biện pháp phòng ngừa an toàn.

MỤC LỤC

Biện pháp phòng ngừa an toàn.....	9
Tháo và sạc	12
Làm sạch các bộ lọc và túi bụi.....	20
Làm sạch trục bàn chải, ống mềm và bánh xe	24
Tháo ngăn chứa pin ra.....	34
Thông tin người tiêu dùng.....	36

Hãy tận hưởng sản phẩm ULTRAPOWER từ Electrolux của quý vị!

This appliance can be used by children aged from 8 years and above and persons with reduced physical, sensory or mental capabilities or lack of experience and knowledge if they have been given supervision or instruction concerning use of the appliance in a safe way and understand the hazards involved. Cleaning and user maintenance of the appliance shall not be made of children without supervision.

- Make sure the vacuum cleaner is stored in a dry place.
- All service or repairs must be carried out by an authorized Electrolux service centre.
- Unplug the charging adapter and remove the battery pack before cleaning or maintaining your ULTRAPOWER.
- Children should be supervised to ensure that they do not play with the appliance.
- Packaging material, e.g. plastic bags should not be accessible to children to avoid suffocation.
- Each vacuum cleaner is designed for a specific voltage. Check that your supply voltage is the same as that stated on the rating plate on the charging adaptor.
- Use only the original charging adaptor designed for ULTRAPOWER
- If the cord is damaged, it must be replaced only by an authorized Electrolux service centre in order to avoid a hazard. Damage to the vacuum cleaner's cord is not covered by the warranty.

Caution

This appliance contains electrical connections:

- Never vacuum any liquid
- Do not immerse in any liquid for cleaning
- The hose should be checked regularly and must not be used if damaged.

Never use the vacuum cleaner or battery pack:

- In wet areas.
- Close to flammable gases, etc.
- When the product shows visible signs of damage.
- On sharp objects or fluids.
- On hot or cold cinders, lighted cigarette butts, etc.
- On fine dust, for instance from plaster, concrete, flour, hot or cold ashes.
- Do not leave the vacuum cleaner or battery pack in direct sunlight.
- Avoid exposing the vacuum cleaner or battery to strong heat.
- The battery pack or the battery cells within must not be dismantled, short circuited, placed against a metal surface .
- Never use the vacuum cleaner without its filters.
- Do not try to touch the brush roll while the cleaner is switched on and the brush roll is turning.

Using the vacuum cleaner in the above circumstances may cause serious personal injury or damage to the product. Such injury or damage is not covered by the warranty or by Electrolux.

EN

KR

IND

CH

TH

TW

VIET

4 안전 주의사항

이 제품은 신체적, 감각적, 또는 정신적 능력이 축소되거나 경험과 지식이 부족한 사람(어린이 포함)의 사용이 제한되어 있습니다. 만약 해당되는 사람이 사용해야 할 경우, 본 제품 사용에 대한 안전을 책임질 수 있는 사람의 감독 또는 주의가 요구됩니다.

EN

KR

IND

CH

TH

TW

VIET

- ULTRAPOWER는 반드시 성인이 사용해야 하며 가정 내에서의 일반적인 진공 청소 시에만 사용해야 합니다.
- 본 진공 청소기는 반드시 건조한 환경에서 보관해야 합니다.
- 모든 서비스 또는 수리는 반드시 공식 Electrolux 서비스 센터에서 받으셔야 합니다.
- ULTRAPOWER를 청소하거나 유지보수 하시기 전에 충전 어댑터의 플러그를 뽑고 배터리 팩을 제거하십시오.
- 어린이가 제품을 가지고 장난하지 않도록 세심한 주의를 기울여야 합니다.
- 아이의 질식사를 방지하기 위해 포장재, 특히 비닐봉지는 아이 손에 닿지 않는 곳에 보관해야 합니다.
- 울트라파워의 어댑터는 220V에 맞게 제작되었습니다. 충전 어댑터에 표시된 정격전압이 220V인지 확인합니다.
- ULTRAPOWER에 지정된 정품 충전 어댑터만을 사용하십시오.
- 전원 코드가 손상된 경우 위험을 방지하기 위해 공식 Electrolux 서비스 센터에서만 교체해야 합니다. 진공 청소기 코드가 손상된 경우, 보증 혜택을 받으실 수 없습니다.

주의

- 이 제품에는 전기 연결부가 포함되어 있습니다.
- 액체가 있는 곳에는 절대 사용하지 마십시오.
- 청소 시 어떤 액체에도 담그지 마십시오.
- 연결 호스를 정기적으로 확인하여 파손된 경우 사용하지 마십시오.

다음과 같은 상황에는 진공 청소기나 배터리 팩의 사용을 금합니다.

- 습기가 있는 지역.
- 인화성 가스 및 기타 유사한 물질과 인접한 지역.
- 제품의 손상 정도가 분명하게 드러난 경우.
- 날카로운 물체 또는 액체 위.
- 뜨겁거나 차가운 담뱃재 또는 불이 붙어 있는 담배 공초 등.
- 미세 먼지, 가령 석고, 콘크리트, 밀가루 및 뜨겁거나 차가운 재가 있는 환경.
- 직사광선에 진공 청소기나 배터리 팩을 두지 마십시오.
- 열이 강한 곳에 진공 청소기 또는 배터리를 두지 마십시오.
- 배터리 팩 또는 배터리 셀은 해체하거나, 단락 또는 금속 표면에 접촉시키지 마십시오.
- 필터를 삽입하지 않은 채로 청소기를 사용하면 안 됩니다.
- 청소기가 작동하고 있으며 브러쉬 롤이 회전하고 있는 경우에는 브러쉬 롤을 만지지 마십시오.

위와 같은 상황에서 진공 청소기를 사용하면 사람에게 심각한 부상이나 제품에 심각한 손상을 입힐 수 있습니다. 그렇게 발생한 부상이나 손상은 보증 혜택을 받을 수 없으며 Electrolux 에서 서비스를 제공하지 않습니다.

Alat ini bukan untuk digunakan oleh orang (termasuk anak kecil) yang memiliki keterbatasan kemampuan secara fisik, indera atau mental, atau tidak berpengalaman dan kurang memiliki pengetahuan, kecuali mereka yang sudah mendapatkan pengarahan atau petunjuk mengenai penggunaannya oleh orang yang bertanggung jawab atas keselamatan mereka.

- ULTRAPOWER sebaiknya hanya digunakan oleh orang dewasa dan untuk tujuan mengisap debu di lingkungan rumah tangga.
- Pastikan Anda menyimpan pengisap debu di tempat yang kering.
- Semua servis atau reparasi harus dilakukan oleh pusat servis resmi Electrolux.
- Cabut adaptor pengisi daya dan lepaskan baterai sebelum membersihkan atau merawat ULTRAPOWER Anda.
- Anak-anak harus diawasi agar mereka tidak bermain dengan alat ini.
- Jauhkan bahan pengemas, misalnya kantong plastik dari jangkauan anak-anak untuk menghindari mati lemas.
- Setiap pengisap debu didesain untuk digunakan pada voltase tertentu. Periksa apakah voltase listrik Anda sama dengan yang tercantum di pelat rating pada adaptor pengisi daya.
- Hanya gunakan adaptor pengisi daya asli yang khusus dirancang untuk ULTRAPOWER
- Kabel yang rusak harus diganti, penggantian hanya boleh dilakukan oleh pusat servis resmi Electrolux untuk menghindari bahaya. Kerusakan kabel pada pengisap debu tidak dikover oleh garansi.

Perhatian

- Alat ini memiliki sambungan listrik:
- Jangan pernah mengisap cairan apapun
- Jangan membersihkan alat dengan direndam di dalam cairan apapun
- Selang harus diperiksa secara rutin dan tidak boleh digunakan jika rusak.

Jangan pernah gunakan pengisap debu atau baterai:

- Di tempat yang basah.
- Di dekat gas yang mudah terbakar, dsb.
- Apabila produk menunjukkan tanda-tanda kerusakan.
- Pada benda tajam atau cairan.
- Pada bara api atau arang bekas pembakaran, puntung rokok yang menyala, dsb.
- Untuk debu yang halus, misalnya debu gips, beton, tepung, abu panas atau dingin.
- Jangan meletakkan pengisap debu atau baterai di bawah sinar matahari langsung.
- Hindarkan pengisap debu atau baterai dari panas yang berlebihan.
- Baterai atau isi baterai di dalamnya tidak boleh dibongkar, dialiri hubungan arus pendek, jangan ditempatkan di atas permukaan logam.
- Jangan menggunakan pengisap debu tanpa memasang saringannya.
- Jangan berusaha menyentuh rol sikat saat alat dihidupkan dan saat rol sikat sedang berputar.

Menggunakan pengisap debu dalam kondisi di atas dapat menyebabkan cedera pribadi atau kerusakan yang serius pada produk. Cedera atau kerusakan yang terjadi tidak dikover oleh garansi ataupun oleh Electrolux.

EN

KR

IND

CH

TH

TW

VIET

6 安全预防措施

本器具不可由肢体伤残、感觉或精神障碍以及缺乏相关经验和知识的人员（包括儿童）使用，除非有负责其安全的人员对其进行看管或指导。

- **ULTRAPOWER** 仅应由成年人操作，并且仅用于家庭环境的普通吸尘清洁。
- 请确保将吸尘器存放于干燥处。
- 所有服务或维修均应由伊莱克斯授权的服务中心进行。
- 清洁或维护 **ULTRAPOWER** 之前，请拔出充电适配器并拆下电池组。
- 应对儿童加以看管，确保他们不将该器具作为玩具。
- 塑料袋等包装材料应放置在儿童不易接近的地方，以免造成窒息危险。
- 每款吸尘器都有特定的电压设计。请检查您的供电电压是否与充电适配器铭牌上的标称电压一致。
- 请仅使用为 **ULTRAPOWER** 设计的原装充电适配器
- 如果电源线受损，为了避免造成危险，必须由伊莱克斯授权的服务中心进行更换。吸尘器电源线的损伤不在产品保修范围之内。

EN

KR

IND

CH

TH

TW

VIET

小心

- 本器具内含电气连接：
- 切勿抽吸任何液体
- 请勿浸入任何液体之中进行清洁
- 应定期检查软管，如有损坏，不得使用。

面临以下情况时，切勿使用吸尘器或电池组：

- 在潮湿环境中。
- 靠近易燃气体等。
- 产品外壳出现明显损坏迹象时。
- 在尖锐物体或液体之上。
- 在热或冷的炭渣、未熄灭的烟蒂等污物之上。
- 在细粉尘（例如石膏粉、水泥、面粉以及热或冷的灰烬）之上。
- 避免吸尘器或电池组受到阳光直射。
- 避免吸尘器或其电池暴露于高温环境下。
- 电池组或其中的电池不得拆卸、短路或接触金属表面放置。
- 切勿在未安装过滤器的情况下使用吸尘器。
- 请勿在吸尘器尚未关闭并且刷辊仍在转动时触碰刷辊。

在上述情况下使用吸尘器，可能会导致人员严重受伤或器具严重损坏。此类受伤或损坏不在伊莱克斯的保修范围内。

อุปกรณ์นี้ไม่ได้ออกแบบมา สำหรับการใช้งานโดยผู้ใหญ่ (และเด็ก) ที่มีความบกพร่องทางร่างกายทางประสาทรับรู้ หรือทางจิตใจ รวมถึงผู้ที่ขาดประสบการณ์ และความรู้ เว้นแต่จะมีผู้ดูแล หรือมีผู้ให้คำแนะนำในการใช้อุปกรณ์อย่างปลอดภัย

- ใช้ ULTRAPOWERS โดยผู้ใช้เพื่อการดูดฝุ่นในอาคารเท่านั้น
- ตรวจสอบให้แน่ใจว่าเครื่องดูดฝุ่นถูกเก็บไว้ในที่แห้ง
- การบริการและการซ่อมแซมทั้งหมดจะต้องดำเนินการโดยศูนย์บริการของ Electrolux
- ถอดปลั๊กหัวชาร์จและนำแบตเตอรี่ออกก่อนทำความสะอาดหรือซ่อมบำรุง ULTRAPOWERS
- เด็กควรมีผู้ดูแล ในการใช้งาน เพื่อให้แน่ใจว่า จะไม่เล่นกับเครื่อง
- วัสดุบรรจุภัณฑ์ เช่น ถุงพลาสติก ควรเก็บไว้ให้พ้นมือเด็ก เพราะอาจทำให้หายใจไม่ออกได้
- เครื่องดูดฝุ่นแต่ละเครื่องได้รับการออกแบบมาภายใต้พิกัดแรงดันไฟฟ้าเฉพาะ ตรวจสอบว่าแรงดันไฟฟ้าที่จ่ายเข้าตรงกับที่ระบุไว้บนแผ่นพิกัดบอกกำลังไฟที่อะแดปเตอร์ชาร์จไฟ
- ใช้เฉพาะหัวต่อชาร์จที่จัดมาให้พร้อมกับ ULTRAPOWERS เท่านั้น
- หากสายไฟเสียหาย ให้เปลี่ยนโดยศูนย์บริการของ Electrolux ที่ได้รับอนุญาตเพื่อป้องกันอันตรายที่อาจเกิดขึ้น ความเสียหายต่อสายเครื่องดูดฝุ่นไม่อยู่ในประกันสินค้า

คำเตือน

- เครื่องมีส่วนเชื่อมต่อทางไฟฟ้า:
- อย่าใช้ดูดของเหลว
- อย่าจุ่มในของเหลวเพื่อทำความสะอาด
- ควรตรวจสอบท่อดูดเป็นประจำ และอย่าใช้งานหากพบว่ามีความเสี่ยง

อย่าใช้เครื่องดูดฝุ่นหรือแบตเตอรี่:

- ในบริเวณที่เปียกชื้น
- ใกล้กับกาซไวไฟ ฯลฯ
- เมื่อตัวเครื่องมีร่องรอยชำรุดเสียหาย
- กับของมีคมหรือของเหลว
- ดูดซีเมนต์หรือเย็น ก้อนหรือดีดไฟ ฯลฯ
- ดูดฝุ่นเนื้อละเอียด เช่น จากปูนปลาสเตอร์ คอนกรีต แป้ง ซีเมนต์หรือเย็น
- อย่าวางเครื่องดูดฝุ่นหรือแบตเตอรี่ไว้ในตำแหน่งที่โดนแสงแดดโดยตรง
- อย่าวางเครื่องดูดฝุ่นหรือแบตเตอรี่ไว้ใกล้กับแหล่งความร้อนสูง
- ห้ามถอดแยกชุดแบตเตอรี่หรือแบตเตอรี่ ลัดวงจร หรือวางไว้บนพื้นผิวโลหะ
- ห้ามใช้เครื่องดูดฝุ่นโดยไม่ติดตั้งที่กรอง
- อย่าพยายามแกะแปรงลูกกลิ้งขณะที่เปิดสวิตซ์เครื่องดูดฝุ่นและแปรงลูกกลิ้งกำลังหมุน

การใช้เครื่องดูดฝุ่นในกรณีนี้อาจทำให้เกิดการบาดเจ็บรุนแรงหรือความเสียหายต่อเครื่อง การบาดเจ็บหรือความเสียหายดังกล่าวไม่อยู่ในการรับประกันสินค้าของ Electrolux

EN

KR

IND

CH

TH

TW

VIET

8 安全防範措施

本機設計不適合體格、感官或精神能力不健全、或者是缺少經驗和知識的人士（包括兒童）使用，除非他們已透過負責他們安全的人士獲得有關使用本設備的監督或說明。

- **ULTRAPOWER** 只能由成年人使用，且僅能作為家用環境的一般吸塵器使用。
- 請確保吸塵器存放於乾燥的地方。
- 所有的維護或修理皆要由授權的 **Electrolux** 服務中心進行。
- 請在清理或維護 **ULTRAPOWER** 之前，先拔除充電器，並取下電池組。
- 請監督兒童確保他們不會把玩本機。
- 切勿讓兒童接觸到包裝材料（如塑膠袋）以預防發生窒息。
- 每台吸塵器都是為特定電壓而設計的。請檢查您的電源電壓與充電轉接器銘牌上標示的是否一樣。
- 僅能使用為 **ULTRAPOWER** 而設計的原廠充電轉接器
- 如果電源線損壞，則必須僅由授權的 **Electrolux** 服務中心更換，以避免危險。保固並不含蓋對吸塵器電源線的損壞。

EN

KR

IND

CH

TH

TW

VIET

注意

本機包含電氣接頭：

不可以吸除任何液體

不可以浸在液體中清洗

應定期檢查軟管，若損壞，則不應使用。

在以下情況絕對不得使用吸塵器或電池組：

- 於濕漉的區域。
- 靠近可燃性氣體等。
- 產品顯示眼睛可見的損壞跡象。
- 用於尖銳物品或液體上。
- 用於高溫或低溫的餘燼、點燃的香煙等。
- 用於微塵，例如來自於灰泥、水泥、麵粉、高溫或低溫灰燼的微塵。
- 切勿將吸塵器或電池組放在陽光直接照射的地方。
- 避免讓吸塵器或電池暴露於高溫下。
- 不可將內部的電池組或電池拆除、短路，或置於金屬表面上。
- 不可在沒有濾網的情況下使用吸塵器。
- 當吸塵器開啟且刷輥正在轉動時，不要嘗試觸摸刷輥。

在上述情況下使用吸塵器，可能會對產品或個人造成嚴重的損害。保固服務或 **Electrolux** 並不負責此類的受傷或損害。

Thiết bị này có thể sử dụng bởi trẻ em từ 8 tuổi và người có thể lực hạn chế, khả năng giác quan hoặc tâm thần yếu, hoặc thiếu kinh nghiệm và kiến thức, nếu như họ được giám sát hoặc hướng dẫn về cách sử dụng thiết bị một cách an toàn và hiểu được những nguy hiểm có thể xảy ra.

- Việc làm sạch và bảo trì không nên được thực hiện bởi trẻ em nếu như không có sự giám sát.
- Đảm bảo máy hút bụi được cất giữ ở nơi khô ráo.
- Mọi việc bảo dưỡng hoặc sửa chữa phải do trung tâm dịch vụ được ủy quyền của Electrolux tiến hành.
- Rút phích cắm bộ sạc điện ra và tháo ngăn chứa pin ra trước khi làm sạch hoặc bảo trì máy ULTRAPOWER của quý vị.
- Trẻ em phải được giám sát để đảm bảo chúng không nghịch phá thiết bị này.
- Các vật liệu bao bì, như túi nhựa, không được để tiếp xúc với trẻ em để tránh trường hợp ngạt thở.
- Tủng máy hút bụi được thiết kế cho một điện áp cụ thể. Kiểm tra xem điện áp cung cấp của bạn có giống như đã ghi trên nhãn máy trên bộ sạc điện hay chưa.
- Chỉ sử dụng bộ sạc điện chính hãng được thiết kế cho ULTRAPOWER.
- Nếu dây điện bị hỏng, nó cần được trung tâm dịch vụ được ủy quyền của Electrolux thay thế để tránh nguy hiểm. Việc làm hỏng dây máy hút bụi không được bao trả theo chế độ bảo hành.

Thận trọng

- Thiết bị này có các kết nối điện.
- Không hút bất kỳ chất lỏng nào
- Không nhúng vào bất kỳ chất lỏng nào để làm sạch
- Phải thường xuyên kiểm tra ống và không được sử dụng nếu ống bị hỏng

Không bao giờ sử dụng máy hút bụi hoặc ngăn chứa pin:

- Ở những khu vực ẩm ướt.
- Ở gần các chất khí dễ cháy, v.v...
- Khi sản phẩm có những dấu hiệu hư hại có thể nhìn thấy được.
- Trên các vật sắc hoặc chất lỏng.
- Trên than xỉ nóng hoặc lạnh, mẫu thuốc lá đã cháy, v.v...
- Trên bụi mịn, chẳng hạn như từ thạch cao, bê tông, bột, tro nóng hoặc lạnh.
- Không được để máy hút bụi hay ngăn chứa pin trực tiếp dưới ánh sáng mặt trời.
- Tránh để máy hút bụi hay pin tiếp xúc với nhiệt mạnh.
- Ngăn chứa pin và ngăn pin bên trong không được phép tháo rời, đoản mạch, đặt trên bề mặt kim loại.
- Không bao giờ sử dụng máy hút bụi mà không có bộ lọc của nó.
- Không được cố chạm vào trục bàn chải trong khi bật máy hút bụi và khi trục bàn chải đang quay.

Việc sử dụng máy hút bụi trong các trường hợp trên có thể gây thương tích nghiêm trọng cho cá nhân và làm hư hỏng nghiêm trọng sản phẩm. Thương tích hay hư hỏng như vậy không được bao trả theo chế độ bảo hành hoặc bởi Electrolux.

EN

KR

IND

CH

TH

TW

VIET

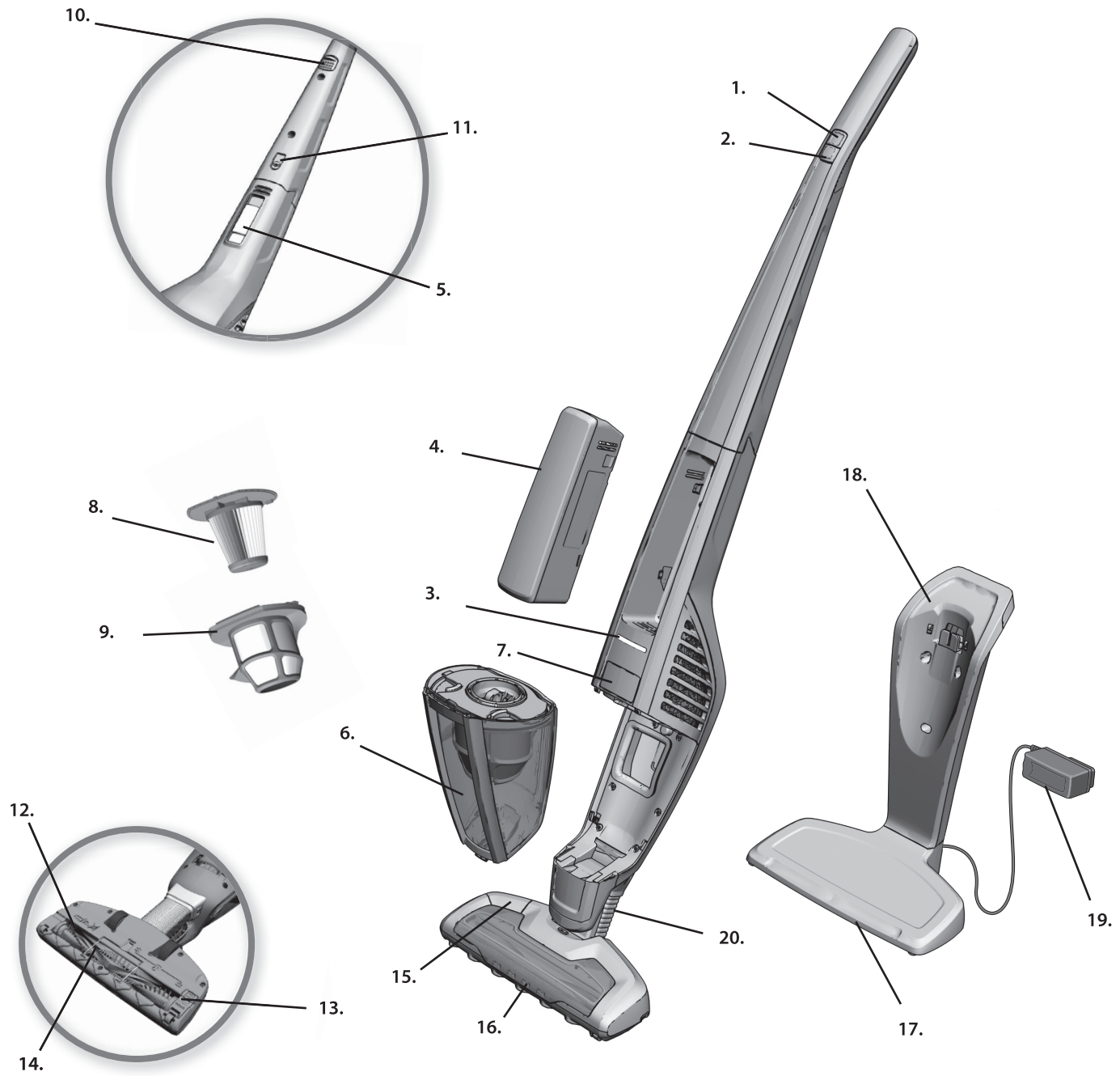

DESCRIPTION OF ULTRAPOWER

1. On/off button
2. Power regulation button
3. Charging/running indicator light
4. Battery pack
5. Battery pack release latch
6. Dust container
7. Dust container release button
8. Fine filter (inner filter)
9. Pre filter (outer filter)
10. Parking hook
11. Locking screw
12. Brush roll
13. Brush roll hatch cover
14. Cable protector
15. BRUSHROLLCLEAN™ pedal
16. Nozzle front lights
17. Charging station, floor unit
18. Charging station, wall unit
19. Charging adaptor
20. Hose

ULTRAPOWER부속품

1. 전원 버튼
2. 흡입력 조절 버튼
3. 충전/작동 표시등
4. 배터리 팩
5. 배터리 팩 분리 버튼
6. 먼지통
7. 먼지통 분리 버튼
8. 1차 필터(내부 필터)
9. 2차 필터(외부 필터)
10. 파킹 스트립
11. 잠금 나사
12. 브러쉬 롤
13. 브러쉬 롤 해지 커버
14. 케이블 보호기
15. 브러쉬 자동 청소™ 버튼
16. 노즐 전면등
17. 충전 거치대 하단부
18. 충전 거치대 상단부
19. 충전 어댑터
20. 연결 호스

PENJELASAN MENGENAI ULTRAPOWER

1. Tombol On/Off
2. Tombol pengatur kekuatan
3. Lampu indikator pengisian daya/sedang mengisi
4. Baterai
5. Kait untuk melepaskan baterai
6. Kantung debu
7. Tombol pelepas kantong debu
8. Filter halus (filter dalam)
9. Pra-filter (filter luar)
10. Pengait
11. Sekrup pengunci
12. Rol sikat
13. Penutup lubang rol sikat
14. Pelindung kabel
15. Pedal BRUSHROLLCLEAN
16. Lampu depan nozzle (mulut pipa)
17. Stasiun pengisian daya, unit lantai
18. Stasiun pengisian daya, unit dinding
19. Adaptor pengisi daya
20. Selang

ULTRAPOWER 说明

1. 电源开关
2. 功率调节按钮
3. 充电/运行指示灯
4. 电池组
5. 电池组释放门
6. 集尘盒
7. 集尘盒释放按钮
8. 细滤器 (内滤器)
9. 预滤器 (外滤器)
10. 停驻钩
11. 锁紧螺丝
12. 刷辊
13. 刷辊仓盖
14. 线缆保护装置
15. BRUSHROLLCLEAN™踏板
16. 吸头正面指示灯
17. 充电站, 地面组件
18. 充电站, 墙壁组件
19. 充电适配器
20. 软管

ULTRAPOWER 說明

1. 開/關按鈕
2. 電力控制按鈕
3. 充電/運作指示燈
4. 電池組
5. 電池組釋放門鎖
6. 集塵容器
7. 集塵容器釋放按鈕
8. 微塵濾網 (內部濾網)
9. 預用濾網 (外部濾網)
10. 停駐鉤
11. 鎖定螺絲
12. 刷輥
13. 刷輥艙蓋
14. 電線保護裝置
15. BRUSHROLLCLEAN™踏板
16. 吸嘴前燈
17. 充電座, 地板裝置
18. 充電座, 牆上裝置
19. 充電轉接器
20. 軟管

รายละเอียดของ ULTRAPOWER

1. ปุ่มเปิด/ปิด
2. ปุ่มควบคุมกำลังดูด
3. ไฟสถานะการชาร์จ/การทำงาน
4. ชุดแบตเตอรี่
5. ฝาปลดล็อกแบตเตอรี่
6. ที่เก็บฝุ่น
7. ปุ่มปลดล็อกที่เก็บฝุ่น
8. ที่กรองละเอียด (ตัวกรองด้านใน)
9. ที่กรองหยาบ (ตัวกรองด้านนอก)
10. ลื่นสำหรับวางพียงขอบโต๊ะ
11. สกรูล็อค
12. แปรงลูกกลิ้ง
13. ฝาครอบของแปรงลูกกลิ้ง
14. ชิ้นส่วนป้องกันสาย
15. แผ่น BRUSHROLLCLEAN™
16. ไฟที่ด้านหน้าหัวดูด
17. แท่นชาร์จแบบวางกับพื้น
18. แท่นชาร์จแบบติดกับผนัง
19. หัวต่อชาร์จ
20. ท่อดูด

BẢN MÔTẢ VỀ ULTRAPOWER

1. Nút bật/ tắt
2. Nút đ ể điều chỉnh ấi
3. Đèn báo sạc/ đ ể ang hoạt đ ể động
4. Ngăn chứa pin
5. Chốt nh ể ngăn chứa pin
6. Túi bụi
7. Nút nh ể túi bụi
8. Bộ lọc mịn (bộ lọc bên trong)
9. Bộ lọc sơ cấp (bộ lọc bên ngoài)
10. Móc treo
11. Đinh vít khóa
12. Trục bàn chải
13. Nắp mở trục bàn chải
14. Lớp bảo vệ cáp
15. Bàn đ ẹp TRUC B ỂN CH Ể ẦM S ỂCH
16. Đèn trước đầu phun
17. Bộ đ ể sạc, thiết bị đ ể đặt trên sàn
18. Bộ đ ể sạc, thiết bị đ ể treo tường
19. Bộ sạc
20. Ống mềm

EN

KR

IND

CH

TH

TW

VIET

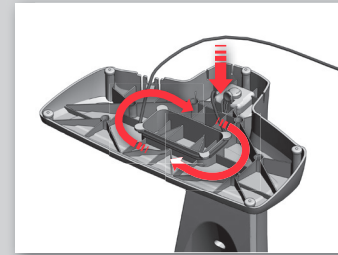
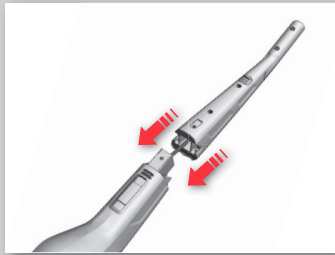

EN

Unpacking and assembly

1. Fit the handle by carefully inserting it into the main body.

KR

포장 풀기 및 조립

1. 손잡이를 주의하여 본체에 삽입해 고정합니다.

IND

Membuka kemasan dan merakit

1. Pasang handel dengan memasukkannya ke bodi utama.

CH

拆除包裝及組裝

1. 將手柄小心地插入吸塵器的主体。

TH

การแกะหีบห่อบรรจุและการประกอบเครื่อง

1. ติดตั้งตามจับโดยสอดเข้าไปในตัวเครื่อง

TW

打開包裝與組裝

1. 小心地將手把插入主體以完成組裝。

VIET

Tháo bao bì và lắp ráp

1. Điều chỉnh tay cầm bằng cách lắp cẩn thận vào phần thân chính.

2. Secure the handle by tightening the locking screw supplied. Use a screwdriver or a coin.

2. 제공된 나사를 조여 손잡이를 고정합니다. 드라이버 또는 동전을 사용합니다.

2. Pasang handel dengan mengencangkan sekrup pengunci yang tersedia. Gunakan obeng atau koin.

2. 固定手柄，方式为拧紧提供的锁紧螺丝。可以使用螺丝刀或硬币。

2. ยึดตามจับโดยขันแน่นสกรูล็อคที่จัดมาให้ ใช้ไขควงหรือเหรียญ

2. 將隨附的鎖定螺絲鎖緊以固定把手。可使用螺絲起子或硬幣。

2. Siết chặt tay cầm bằng cách vặn chặt ốc vít khóa được đi kèm với máy. Dùng tua vít hoặc cái nệm.

Charging station

1. Connect the plug it to the charging stand. There is a hollow space in the bottom of the charging station where unused cable can be wound .

충전 거치대

1. 충전 거치대에 플러그를 연결합니다. 충전 거치대 밑에는 불필요한 케이블을 감아 보관할 수 있는 움푹한 공간이 있습니다.

Stasiun pengisian daya

1. Sambungkan steker ke tempat pengisian daya. Terdapat ruang kosong di dasar stasiun pengisian daya dimana kabel yang tidak terpakai bisa rusak.

充電站

1. 將插頭連接到充電基座。充電站底部為中空式，不使用時可將線纜纏繞在該處。

แท่นชาร์จ

1. เสียบปลั๊กเข้ากับฐานชาร์จ จะมีช่องกวางอยู่ที่ด้านล่างของชุดชาร์จเพื่อใช้ขดสายที่ไม่ได้ใช้งาน

充電座

1. 將插頭插入充電座。在充電座底下有一個中空的區域，可將未使用的電線捲起存放於此。

Bộ đế sạc

1. Cắm phích bộ đế sạc với bộ sạc. Có một khoảng trống ở dưới đáy bộ đế sạc nơi có thể quấn cáp không sử dụng đến .



2. Insert the adaptor into the mains and position the charging station on a stable and horizontal surface away from heat sources, direct sunlight or wet places.

2. 어댑터를 충전 거치대에 연결한 후, 충전 거치대를 발열 물질, 직사광선 또는 젖은 공간을 피해 안전하고 수평한 평면에 놓습니다.

2. Colokkan adaptor ke sumber listrik dan stasiun pengisian daya pada posisi stabil dan horizontal jauh dari sumber panas, sinar matahari langsung atau tempat yang basah.

2. 将适配器插入电源，并将充电站放置在远离热源、直接光照或潮湿位置的稳固水平面上。

2. สอดหัวต่อเข้าไปในส่วนจ่ายไฟหลัก จากนั้นจัดวางชุดชาร์จไว้บนพื้นผิวที่ได้ระนามและมั่นคง รวมทั้งจะต้องไม่อยู่ใกล้ความร้อน แสงแดดหรือพื้นที่เปียกชื้น

2. 將轉接器插入主電源，並把充電座放在穩定平面上，並使之遠離熱源、陽光直射或濕漉的地方。

2. Cắm bộ sạc vào nguồn điện và Đặt bộ đế sạc trên bề mặt chắc chắn và nằm ngang cách xa các nguồn nhiệt, ánh sáng mặt trời trực tiếp hoặc chỗ ẩm ướt.

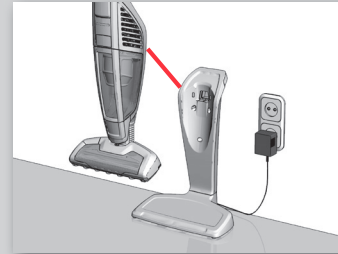

Charging ULTRAPOWER

The charging indicator will be lit when ULTRAPOWER is placed in the charging station. When ULTRAPOWER is fully charged, the charging indicator will blink slowly every 5 seconds.

ULTRAPOWER 충전하기

ULTRAPOWER가 충전 거치대에 놓여 있으면 충전 표시등이 들어옵니다. ULTRAPOWER가 완전히 충전되면, 충전 표시등은 매 5초마다 느리게 깜빡입니다.

Mengisi daya ULTRAPOWER

Indikator pengisian akan menyala ketika ULTRAPOWER ditempatkan di stasiun pengisian daya. Jika ULTRAPOWER sudah terisi penuh, indikator pengisi daya akan berkedip pelan selama 5 detik.

为 ULTRAPOWER 充电

将 ULTRAPOWER 放置到充电站中时，充电指示灯会亮起。ULTRAPOWER 的电充满时，充电指示灯会以每 5 秒一次的速度缓慢闪烁。

การชาร์จ ULTRAPOWER

ไฟแสดงการชาร์จจะติดสว่างเมื่อวาง ULTRAPOWER ไว้ที่ชุดชาร์จ ในกรณีที่ ULTRAPOWER ชาร์จไฟเต็ม ไฟแสดงการชาร์จจะติดกะพริบช้า ๆ ทุก 5 วินาที

對 ULTRAPOWER 充電

當 ULTRAPOWER 被放在充電座時，充電指示燈將會點亮。當 ULTRAPOWER 充飽電時，充電指示燈將會緩慢地每五秒閃一次燈。

Sạc ULTRAPOWER

Đèn chỉ báo sạc sẽ sáng khi đặt ULTRAPOWER trong bộ đế sạc. Khi ULTRAPOWER được sạc đầy, đèn chỉ báo sạc sẽ nhấp nháy chậm chậm cứ 5 giây một lần.

EN

KR

IND

CH

TH

TW

VIET

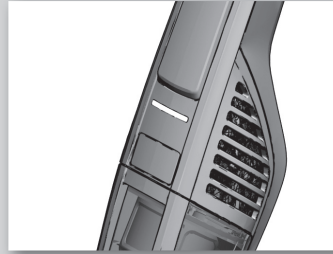

EN

On ULTRAPOWER Lithium the number of LED lamps will indicate the level of charge. 3 LED = fully charged.

If ULTRAPOWER is fully discharged it requires approximately 4 hours to regain the full battery capacity.

KR

ULTRAPOWER 리튬 모델의 경우 LED 램프의 개수는 충전 상태를 표시합니다. 3개 LED = 완전히 충전됨.

ULTRAPOWER가 완전히 방전된 경우, 배터리가 다시 완전히 충전되려면 대략 4시간 정도 충전해야 합니다.

IND

Jumlah lampu LED pada ULTRAPOWER Litium mengindikasikan tingkat pengisian daya. 3 LED = terisi penuh.

Jika ULTRAPOWER telah habis sepenuhnya, dibutuhkan waktu sekitar 4 jam untuk mendapatkan kapasitas baterai penuh.

CH

对于 ULTRAPOWER 锂电池，点亮的 LED 指示灯的数量指示充电量水平。3 个LED = 电充满。

如果 ULTRAPOWER 的电量完全用完，则需要约 4 个小时才能重新将电池充满。

TH

จำนวนของช่องไฟ LED บนด้านหน้าของ ULTRAPOWER Lithium มีเพื่อแสดงการชาร์จไฟ, ถาแสดงเต็ม 3 ช่อง = ชาร์จไฟเต็ม

หาก ULTRAPOWER หมดประจุ จะต้องใช้เวลาชาร์จไฟประมาณ 4 ชั่วโมง เพื่อให้แบตเตอรี่เต็มอีกครั้ง

TW

在 ULTRAPOWER 機身上，LED 燈亮的數目代表充電的程度。3 個 LED 燈 = 充飽電。

如果 ULTRAPOWER 完全沒電，需大約 4 小時的充電才能充足全部的電池電力。

VIET

Số lượng đèn LED trên ULTRAPOWER Lithium sẽ chỉ báo mức sạc. 3 LED = đã sạc đầy.

Nếu ULTRAPOWER đã xả hết điện, cần xấp xỉ 4 giờ để sạc lại đầy đủ dung lượng pin.

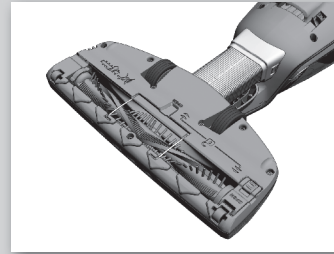

For better battery performance, always keep ULTRAPOWER on charge when it is not being used.

배터리 성능을 최적으로 유지하려면, ULTRAPOWER 를 미 사용시 항상 충전하십시오.

Isi daya ULTRAPOWER saat tidak digunakan untuk mendapatkan performa baterai yang lebih baik.

为提升电池的性能，不使用时，请始终将 ULTRAPOWER 保持充电状态。

เพื่อให้แบตเตอรี่ทำงานได้เต็มประสิทธิภาพ ให้ชาร์จ ULTRAPOWER ไว้เมื่อไม่ได้ใช้งาน

不使用 ULTRAPOWER 時，務必讓其持續充電以確保最佳電池效能。

Để có hiệu suất pin tốt hơn, hãy luôn để sạc ULTRAPOWER khi không được sử dụng.

Vacuuming with ULTRAPOWER

Before vacuuming, check that the nozzle wheels and the brush roll are clean from sharp objects in order to avoid scratching sensitive floors and to ensure full cleaning performance.

ULTRAPOWER 로 진공 청소하기

진공 청소를 하기 전에, 노즐 바퀴와 브러쉬 롤 주변에 날카로운 물체가 있는지 확인하여 민감한 바닥의 긁힘을 방지하고 완벽한 청소 성능을 유지하십시오.

Mengisap debu dengan ULTRAPOWER

Sebelum mengisap debu, cek apakah roda nozzle (mulut pipa) dan rol sikat bersih dari benda tajam untuk menghindari goresan pada lantai yang sensitif dan untuk memastikan performa pembersihan secara menyeluruh.

使用 ULTRAPOWER 进行吸尘清洁

进行吸尘清洁之前，应检查吸头滚轮和刷辊上是否没有锋利物体，以避免划伤脆弱的地面并确保完全发挥清洁性能。

การดูดฝุ่นด้วย ULTRAPOWER

ก่อนดูดฝุ่น ให้ตรวจสอบว่าล้อของหัวดูดและแปรงลูกกลิ้งไม่มีวัสดุที่แหลมคมติดค้างอยู่ ทั้งนี้เพื่อป้องกันไม่ให้เกิดรอยขีดข่วนบนพื้นที่เป็นรอยง่ายและเพื่อให้อากาศสะอาดได้อย่างมีประสิทธิภาพสูงสุด

使用 ULTRAPOWER 吸塵器

在使用吸塵器之前，請確認吸嘴滾輪及刷棍是否沒有尖銳物，以便預防刮傷脆弱的地板，並確保有完全的清潔效能。

Hút bụi với ULTRAPOWER

Trước khi hút bụi, hãy kiểm tra bánh xe đầu phun và trục bàn chải để đảm bảo chúng không có vật sắc để tránh làm trầy xước những sàn nhà dễ bị hỏng và để đảm bảo có được hiệu năng làm sạch đầy đủ.

EN

KR

IND

CH

TH

TW

VIET

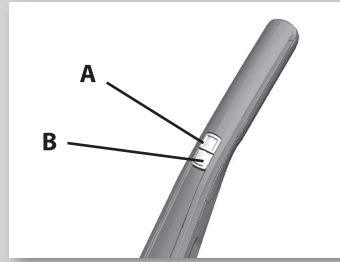

EN

Start and stop ULTRAPOWER by pushing the ON/OFF button A. ULTRAPOWER has 3 power settings which is regulated with button B

1. ULTRAPOWER will start on the "normal mode".
2. For tougher cleaning jobs, press the power regulation button "B" once for "Booster mode".
3. For more silent cleaning, press the B button one more time to activate the "Silent mode".

KR

전원 버튼을 눌러 ULTRAPOWER를 시작 및 정지하십시오. ULTRAPOWER는 3가지로 흡입력을 조절할 수 있으며 전원 버튼 아래 흡입력 조절 버튼으로 조절 가능합니다.

1. ULTRAPOWER는 항상 "노멀 모드"로 시작합니다.
2. 오염이 심한 경우, 흡입력 조절 버튼(B)을 눌러 "부스터 모드"를 작동시킵니다.
3. 보다 조용한 청소를 원할 경우, 흡입력 조절 버튼(B)을 한 번 더 눌러 "룸 모드"를 작동시킵니다.

IND

Tekan tombol A ON/OFF untuk menyalakan dan mematikan ULTRAPOWER. ULTRAPOWER mempunyai 3 pengaturan kekuatan yang diatur dengan tombol B

1. Ultrapower akan selalu berada pada 'Power Mode' ketika pertama kali dinyalakan yang akan memberikan kinerja tingkat tinggi hingga 20 menit.
2. Untuk pembersihan yang lebih bertenaga, tekan tombol B satu kali untuk mengaktifkan 'Booster Mode' yang akan memberikan performa maksimum hingga 15 menit.
3. Untuk pembersihan regular, tekan tombol B dua kali untuk mengaktifkan 'Regular Mode' yang akan memberikan kinerja daya selama 40-60 menit.

CH

按下电源开关 A 启动或停止 ULTRAPOWER。ULTRAPOWER 具有 3 种功率设置，可通过按钮 B 调节

1. Ultrapower 启动时通常为“强力模式”。
2. 对于顽渍，按一下 B 按钮以启动“增压模式”。
3. 对于常规清洁，按两下 B 按钮以启动“常规模式”。

TH

เปิดและปิด ULTRAPOWER โดยกดปุ่ม ON/OFF A ULTRAPOWER มีค่าระดับพลังงาน 3 ค่าที่ควบคุมผ่านปุ่ม B

1. Ultrapower จะเริ่มทำงานใน "Power Mode" ทุกครั้ง ซึ่งจะให้มีเวลาทำงานในระดับสูงสุดไม่เกิน 20 นาที
2. สำหรับการทำความสะอาดในพื้นที่ที่สกปรกมาก ให้กดปุ่ม B หนึ่งครั้งเพื่อเปิดใช้ "Booster Mode" ซึ่งจะให้มีเวลาทำงานระดับสูงสุดไม่เกิน 15 นาที
3. สำหรับการทำความสะอาดทั่วไป ให้กดปุ่ม B สองครั้งเพื่อเปิดใช้ "Regular Mode" ซึ่งจะให้มีเวลาทำงานตามปกติ 40-60 นาที

TW

按 ON/OFF (開/關) 按鈕 A 以啟動或關閉 ULTRAPOWER。ULTRAPOWER 有三種動力設定，您可使用按鈕 B 來調控。

1. Ultrapower 永遠會從「動力模式」開始。
2. 若要強效清潔，請按 B 按鈕一次以啟動「增強模式」。
3. 若要一般清潔，按 B 按鈕兩次以啟動「一般模式」。

VIET

Hãy bắt đầu và dừng ULTRAPOWER bằng cách nhấn nút A ON/OFF (BẬT/TẮT). ULTRAPOWER có 3 cài đặt nguồn điện được điều chỉnh bằng nút B

1. Ultrapower sẽ luôn khởi động ở 'Chế Độ Thường'
2. Để làm sạch mạnh nhất, nhấn một lần nút B để kích hoạt 'Chế Độ Tăng Cường'
3. Để làm sạch không ồn, nhấn hai lần nút B để kích hoạt 'Chế Độ Không Ổn'

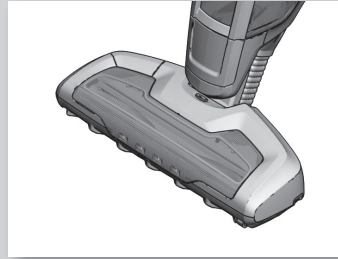

BRUSH ROLL CLEAN TECHNOLOGY™

All ULTRAPOWER models are equipped with BRUSH ROLL CLEAN™ Technology – a function that helps to keep the brush roll free from hair and fibres.

It is recommended to use this function once a week. For best results use the BRUSH ROLL CLEAN™ function when ULTRAPOWER is fully charged.

EN

BRUSH ROLL CLEAN TECHNOLOGY™ (브러쉬 자동 청소 기능)

모든 ULTRAPOWER 모델에는 브러쉬 자동 청소 기능이 적용되어 브러쉬 롤에서 머리카락이나 실 등을 제거할 수 있습니다.

이 기능은 매주 1회 정도 사용하기를 권장합니다. 브러쉬 자동 청소™ 기능은 ULTRAPOWER가 완전히 충전된 상태에서 가장 최적의 성능을 발휘합니다.

KR

TEKNOLOGI BRUSH ROLL CLEAN™

Semua model ULTRAPOWER dilengkapi dengan teknologi BRUSH ROLL CLEAN – fungsi yang menjaga rol sikat bebas dari rambut dan serat kain.

Anda disarankan untuk menggunakan fungsi ini sekali seminggu. Untuk hasil terbaik gunakan fungsi BRUSH ROLL CLEAN ketika baterai ULTRAPOWER terisi penuh.

IND

BRUSH ROLL CLEAN TECHNOLOGY™ (刷辊清洁技术)

所有 ULTRAPOWER 型号均配备了 BRUSH ROLL CLEAN™ (刷辊清洁) 技术 – 这种功能可帮助刷辊不被头发和纤维缠住。

此项功能建议每周使用一次。为获得最佳效果，请在 ULTRAPOWER 充满电时，使用 BRUSH ROLL CLEAN™ (刷辊清洁) 功能。

CH

เทคโนโลยี BRUSH ROLL CLEAN

ULTRAPOWER ทุกรุ่นจำหน่ายพร้อมเทคโนโลยี BRUSH ROLL CLEAN ซึ่งจะช่วยให้แปรงลูกกลิ้งปราศจากเศษผมและเส้นใยต่าง ๆ

ขอแนะนำให้ใช้ฟังก์ชันนี้สัปดาห์ละครั้ง เพื่อให้ได้ผลดีที่สุด ให้ใช้ฟังก์ชัน BRUSH ROLL CLEAN เมื่อชาร์จไฟ ULTRAPOWER ไว้เต็ม

TH

BRUSH ROLL CLEAN 技術

每一種 ULTRAPOWER 型號都採用 BRUSH ROLL CLEAN 技術，這是一種保持刷輥上無毛髮與纖維的功能。

建議每週使用這個功能一次。請在 ULTRAPOWER 充電時使用 BRUSH ROLL CLEAN 功能以獲得最佳效果。

TW

CÔNG NGHỆ BRUSH ROLL CLEAN (LÀM SẠCH BẰNG TRỤC BÀN CHẢI)

Tất cả các model ULTRAPOWER đều được trang bị Công Nghệ BRUSH ROLL CLEAN – chức năng giúp giữ trục bàn chải không dính tóc và sợi vải.

Nên sử dụng chức năng này một lần một tuần. Để có các kết quả tốt nhất hãy sử dụng chức năng BRUSH ROLL CLEAN™ khi đã sạc đầy ULTRAPOWER

VIET

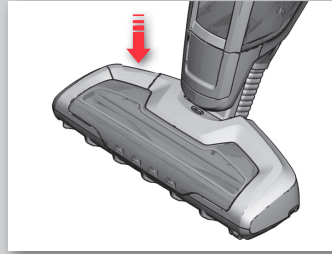

EN

1. Place ULTRAPOWER on a hard and even surface. Do not use the BRUSH ROLL CLEAN™ function on carpets.

2. Press the BRUSH ROLL CLEAN™ pedal with your foot while the cleaner is switched on. Hold for 5 seconds until hairs and fibres are removed and then release the pedal. There will be a cutting noise during this process, this is normal. If hairs remain on the brush roll repeat the process.

IND

Please note that the BRUSH ROLL CLEAN™ function might not be able to remove thicker threads, wires or fibres that are caught in the brush roll. See chapter "Removing the brush roll" for these situations.

CH

TH

1. 단단하고 평평한 표면에 ULTRAPOWER를 놓으십시오. 브러쉬 자동 청소™ 기능은 카페트에서 사용하지 마십시오.

2. 청소기가 작동하는 동안 브러쉬 자동 청소 버튼을 발로 누릅니다. 머리카락이나 실 등이 없어질 때까지 5초간 누르고 있다가 버튼에서 발을 뗍니다. 이 기능을 사용하는 동안 잘라지는 소리가 들리지만 정상입니다. 머리카락이 브러쉬 롤에 남아있으면 이 과정을 반복합니다.

VIET

브러쉬 자동 청소™ 기능으로 브러쉬 롤에 걸려 있는 굵은 실, 철사 또는 실 등은 제거하지 못할 수 있습니다. 이러한 상황이 발생한 경우, "브러쉬 롤 청소하기" 부분을 참조하십시오.

1. Tempatkan ULTRAPOWER di atas tempat yang keras dan datar. Jangan gunakan fungsi BRUSH ROLL CLEAN di atas karpet.

2. Tekan pedal BRUSH ROLL CLEAN™ dengan kaki Anda sementara pembersihan dijalankan. Tahan 5 detik sampai rambut dan serat kain hilang dan lepaskan pedal. Selama proses ini normal jika terdengar bising. Ulangi proses jika masih ada rambut yang tersisa.

Mohon diingat bahwa fungsi BRUSH ROLL CLEAN mungkin tidak dapat membersihkan benang tebal, kabel atau serat kain pada rol sikat. Lihat bab "Melepaskan rol sikat" untuk kondisi di atas.

1.將 ULTRAPOWER 放置在坚硬平坦的表面上。切勿在地毯上使用 BRUSH ROLL CLEAN™（刷辊清洁）功能。

2.启动吸尘器后，用脚踏下 BRUSH ROLL CLEAN™（刷辊清洁）踏板。持续 5 秒，直到头发和纤维被去除后，再松开踏板。此过程中可能会出现切割声，这很正常。如果刷辊上仍然有头发，请重复此过程。

请注意，BRUSH ROLL CLEAN™（刷辊清洁）功能无法去除刷辊上缠绕的较粗的线、丝或纤维。有关此类状况的信息，请参见“拆卸刷辊”一章。

1. วาง ULTRAPOWER ไว้บนพื้นผิวที่เรียบและมั่นคง อย่าใช้ฟังก์ชัน BRUSH ROLL CLEAN กับพรม

2. เหยียบที่แป้น BRUSH ROLL CLEAN ขณะเปิดเครื่อง กดค้างไว้ 5 นาทีจนกระทั่งเศษผมและเส้นใยต่าง ๆ หลุดออก จากนั้นจึงยกเท้าออก จะมีเสียงตัดให้ได้ยินระหว่างขั้นตอนนี้ซึ่งถือเป็นเรื่องปกติ หากยังมีเศษผมอยู่ที่แปรงลูกกลิ้ง ให้ทวนซ้ำขั้นตอนนี้

ฟังก์ชัน BRUSH ROLL CLEAN อาจไม่สามารถขจัดเส้นใย ลวดหรือด้ายที่หนาและติดค้างอยู่ในแปรงลูกกลิ้งได้ ดูในหัวข้อ "การถอดแปรงลูกกลิ้ง" ในกรณีนี้

1. 把 ULTRAPOWER 放在一坚硬平整的平面上。不可以在地毯上使用 BRUSH ROLL CLEAN 功能。

2. 在吸尘器啟動後，用腳踩下 BRUSH ROLL CLEAN 踏板。踩住 5 秒，並等到毛髮與纖維都清除後再鬆開踏板。過程中會出現切碎的聲音，此乃正常現象。若刷輥上仍殘留毛髮，請重複上述程序。

請注意 BRUSH ROLL CLEAN 功能可能無法除去卡在刷輥上較粗的線絲、電線或纖維。對於此類情況，請詳閱「取出刷輥」一章。

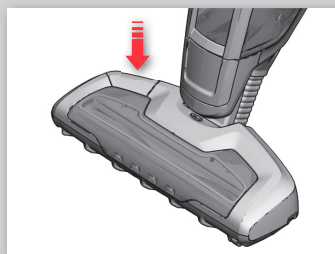

1. Đặt ULTRAPOWER lên bề mặt cứng và bằng phẳng. Không sử dụng chức năng BRUSH ROLL CLEAN™ trên các tấm thảm.

2. Dùng chân nhấn bàn đạp BRUSH ROLL CLEAN™ trong lúc máy hút bụi được bật. Giữ trong 5 giây cho đến khi gỡ được hết tóc và sợi vải ra và sau đó nhả bàn đạp. Sẽ có tiếng ồn cắt trong suốt quá trình này, điều này là bình thường. Nếu tóc vẫn ở trên trục bàn chải hãy lặp lại quá trình này.

Vui lòng lưu ý rằng chức năng BRUSH ROLL CLEAN™ không thể gỡ bỏ được các sợi chỉ, dây điện hay sợi vải dày hơn bị mắc trong trục bàn chải. Xem chương "Tháo trục bàn chải" để biết về các tình huống này.

EN

KR

IND

CH

TH

TW

VIET

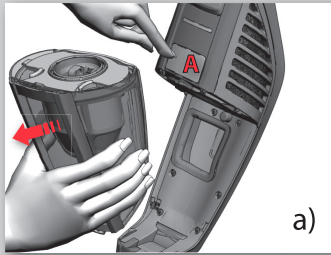

a)

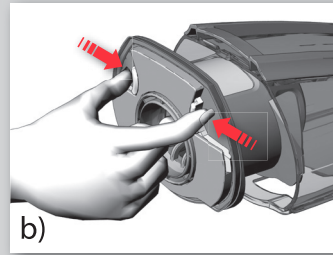

b)

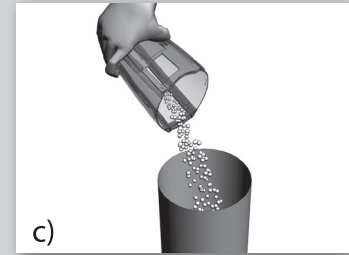

c)

EN

Emptying of the dust container.

a) Open the dust container by pressing the dust container button (A).

KR

먼지통을 비웁니다.

a) 먼지통 버튼(A)을 눌러 먼지통을 엽니다.

IND

Kosongkan kantong debu.

a) Buka kantong debu dengan memencet tombol kantong debu (A).

CH

清空集尘盒。

a) 按下集尘盒按钮 (A) 打开集尘盒。

TH

การทิ้งฝุ่นในที่เก็บฝุ่น

a) เปิดที่เก็บฝุ่นโดยกดที่ปุ่ม (A) ของที่เก็บฝุ่น

TW

集塵容器的清空。

a) 按下集塵容器按鈕 (A) 以開啟集塵容器。

VIET

Đổ sạch túi bụi.

a) Mở túi bụi bằng cách nhấn nút túi bụi (A).

b) Take out the filters by pressing the release buttons

b) 분리 버튼을 눌러 필터를 분리합니다.

b) Lepaskan filter dengan menekan tombol pelepas

b) 按下释放按钮取出过滤器

b) นำที่กรองออกโดยกดปุ่มปลดลิอด

b) 按下釋放按鈕以取出濾網

b) Lấy bộ lọc ra bằng cách nhấn các nút nhà

c) Empty the contents into a dustbin.

Never wash the dust container or filters in a dishwasher.

c) 먼지를 쓰레기 통에 버립니다.
식기세척기에서 먼지통이나 필터를 세척하지
마십시오.

c) Buang isinya ke tempat sampah.
*Jangan mencuci kantong debu atau saringan di
bak cuci piring.*

c) 将灰尘全部倒入垃圾箱。
切勿使用洗碗机清洗集尘盒或过滤器。

c) นำเศษผงต่าง ๆ ที่ตกลงในถังขยะ
ห้ามลงในที่เก็บฝุ่นหรือที่กรองโดยใช้เครื่องล้างจาน

c) 將內含物倒入集塵垃圾桶。
絕不可用洗碗機清洗集塵容器或濾網。

c) Đổ bụi vào trong thùng rác.
*Không bao giờ được giặt túi bụi hay bộ lọc trong máy
rửa bát.*

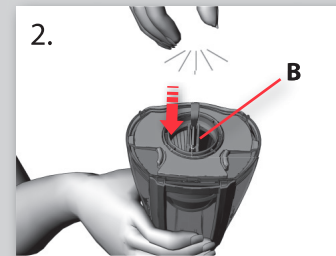
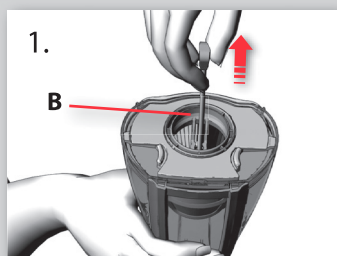

Quick cleaning of the inner filter. (Recommended at every emptying).
Open the dust container

내부 필터 간단히 청소하기. (먼지통을 비울 때 마다 사용하는 것을 권장합니다.)
먼지통을 엽니다.

Membersihkan filter dalam dengan cepat. (Disarankan untuk setiap pembersihan).
Buka kantong debu

快速清洁内滤器。 (建议每次清空后进行此项清洁)。
打开集尘盒

การทำความสะอาดตัวกรองด้านในอย่างรวดเร็ว (แนะนำให้ทำทุกครั้งที่ตั้งเศษฝุ่น)
เปิดที่เก็บฝุ่น

快速清潔內部濾網。 (建議於每次清空時進行)。
開啟集塵容器

Làm sạch nhanh bộ lọc bên trong. (Nên thực hiện trong mọi lần đổ sạch túi bụi).
Mở túi bụi ra

1. Pull the filter cleaning rod (B) to its end position and release it to remove dust from the inner filter.
2. Repeat 5 times.

1. 필터 청소 봉 (B)을 끝 쪽으로 잡아 당겼다 놓습니다. 이 작업을 통해 먼지가 이너필터에서 떨어져 나갑니다.
2. 5회 반복합니다.

1. Tarik tuas pembersih filter (B) sampai ke ujung atas dan lepaskan tuasnya untuk membersihkan debu dari filter dalam.
2. Ulangi 5 kali.

1. 将过滤器清洁杆 (B) 拉到末端然后释放，以去除内滤器上的灰尘。
2. 重复 5 次。

1. ดึงแกนทำความสะอาดที่กรอง (B) ให้สุด จากนั้นนำออกมาเพื่อขจัดฝุ่นออกจากที่กรองด้านใน
2. ทวนซ้ำขั้นตอน 5 ครั้ง

1. 把濾網清潔桿 (B) 拉到底，然後釋放，以除去內部濾網的灰塵。
2. 重複上述步驟 5 遍。

1. Kéo cần làm sạch bộ lọc (B) tới vị trí cuối và thả ra để loại bỏ bụi khỏi bộ lọc bên trong.
2. Lặp lại 5 lần.

EN

KR

IND

CH

TH

TW

VIET

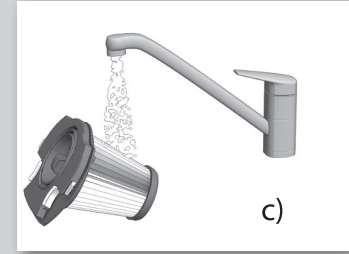
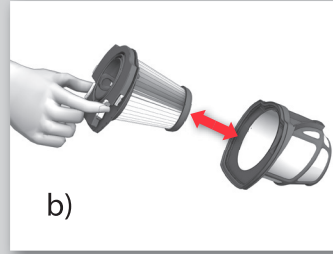
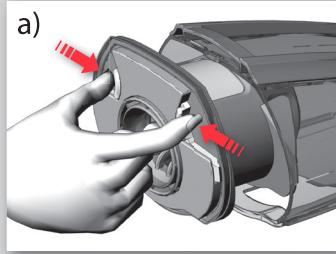

EN

3. Cleaning the filters. (Recommended every 5th emptying).

a) Take out both filters by pressing the release buttons
b) Separate both filters.

c) Rinse the filter parts carefully under lukewarm water without using any detergents. (*never use the dishwasher or washing machine*)

KR

3. 필터 청소하기. (먼지통을 5회 비울 때 마다 사용하는 것을 권장합니다.)

a) 분리 버튼을 눌러 필터를 분리합니다.
b) 필터 두 개를 모두 분리합니다.

c) 세제를 사용하지 말고 미지근한 물에 필터 부품을 주의하여 행굽니다. (*식기세척기 또는 세탁기를 사용하지 마십시오.*)

IND

3. Membersihkan saringan. (Disarankan setiap 5 kali pembersihan).

a) Lepaskan kedua saringan dengan menekan tombol pelepas
b) Pisahkan kedua saringan.

c) Cuci komponen saringan secara hati-hati dengan air hangat yang mengucur tanpa deterjen. (*jangan pernah gunakan mesin cuci piring atau mesin cuci*)

CH

3. 清洗过滤器。 (建议每清空 5 次后进行此项清洁)。

a) 按下释放按钮取出两只过滤器
b) 分离两只过滤器。

c) 用不加任何清洁剂的微温清水仔细冲洗过滤器部件。 (*切勿使用洗碗机或洗衣机*)

TH

3. การทำความสะอาดที่กรอง (แนะนำให้ทำทุก 5 ครั้งที่มีการทิ้งเศษฝุ่น)

a) นำที่กรองทั้งสองส่วนออกโดยกดปุ่มปลดล็อค
b) แยกที่กรองทั้งสองส่วน

c) ล้างที่กรองอย่างระมัดระวังในน้ำอุ่นโดยไม่ต้องใช้น้ำยาซักฟอก (*อย่าใช้เครื่องล้างจานหรือเครื่องซักผ้า*)

TW

3. 清潔濾網。 (建議每 5 次清空時進行)。

a) 按下釋放按鈕以取出兩個濾網
b) 將兩個濾網分離。

c) 使用溫水清洗濾網零件，不要使用任何清潔劑。 (*絕對不可使用洗碗機或洗衣機*)

VIET

3. Làm sạch các bộ lọc. (Nên làm sạch bộ lọc mỗi khi đổ sạch túi bụi lần thứ 5).

a) Lấy cả hai bộ lọc ra bằng cách nhấn các nút nhà
b) Tách riêng cả hai bộ lọc.

c) Rửa sạch các bộ phận của bộ lọc thật cẩn thận bằng nước ấm mà không sử dụng bất kỳ chất tẩy rửa nào. (*không bao giờ sử dụng máy rửa bát hoặc máy giặt*)

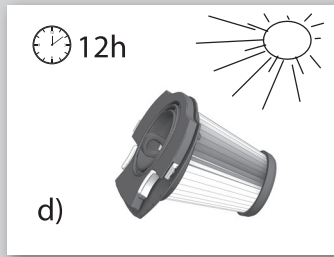

d) Shake to remove excess water and leave to dry minimum 12h.
Make sure that the filter parts are completely dried before putting them back into the cleaner.

d) 필터를 흔들어 남아 있는 물을 제거한 후 최소 12시간동안 건조합니다.
 청소기에 다시 넣기 전에 필터 부품이 완전히 건조되었는지 확인합니다.

d) Kocok-kocok untuk mengeluarkan air yang tersisa dan biarkan hingga kering setidaknya 12 jam.
Pastikan bahwa seluruh komponen saringan kering sebelum memasukkannya kembali ke dalam alat.

d) 摇晃甩出多余的水分，并静置待其晾干（至少 12 小时）。
 确保过滤器部件完全干燥后，才能将它们装回吸尘器中。

d) สะบัดไล่น้ำออกแล้วปล่อยให้แห้งอย่างน้อย 12 ชั่วโมง
 ชิ้นส่วนของที่กรองจะต้องแห้งสนิทก่อนใส่กลับเข้าไปในเครื่องดูดฝุ่น

d) 甩動以除去多餘水分，並晾乾至少 12 小時。
 請確保濾網零件已完全乾燥後再放回吸塵器內。

d) Lắc để loại bỏ hết nước dư thừa và để khô tối thiểu trong 12 giờ.
Chắc chắn rằng các bộ phận của bộ lọc đều khô hoàn toàn trước khi đặt trở lại vào trong máy hút bụi.

IMPORTANT - FILTER CLEANING !
The filters must be cleaned at regular intervals to ensure a high cleaning performance

중요 - 필터 청소하기!
 청소 성능을 높은 수준으로 유지하려면 필터를 정기적으로 청소하십시오.

PENTING - MEMBERSIHKAN SARINGAN !
Saringan harus dibersihkan secara teratur untuk mendapatkan performa pembersihan yang tinggi

重要事項 - 过滤器清洁!
 必须定期清洁过滤器，才能确保高清洁性能

ข้อสำคัญ - การทำความสะอาดที่กรอง!
 ต้องทำความสะอาดที่กรองเป็นประจำเพื่อให้เครื่องดูดฝุ่นได้อย่างเต็มประสิทธิภาพ

重要事項 - 清潔濾網!
 必須定期清理濾網以確保有高效能的清潔功能。

QUAN TRỌNG - LÀM SẠCH BỘ LỌC!
Các bộ lọc phải được làm sạch theo chu kỳ thường xuyên để đảm bảo hiệu quả làm sạch cao

EN

KR

IND

CH

TH

TW

VIET

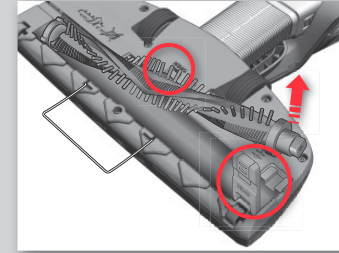
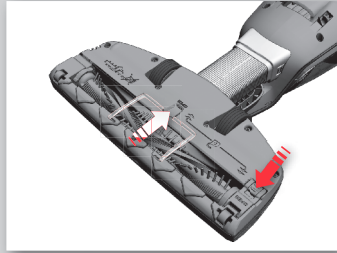

EN

Removing the brush roll

To clear the brush roll from thicker threads or wires follow these instructions:

KR

브러쉬 롤 청소하기

브러쉬 롤에서 두꺼운 실이나 철사등을 제거하려면 다음 지침을 따르십시오.

IND

Melepaskan rol sikat

Ikuti instruksi berikut untuk membersihkan rol sikat dari benang tebal atau kabel:

CH

拆卸刷辊

要清理刷辊上的较粗的线或丝，请遵循以下说明进行操作：

TH

การถอดแปรงลูกกลิ้ง

ขจัดเศษขดสายและเส้นใยหรือเส้นลวดออกจากแปรงลูกกลิ้งโดยทำตามคำแนะนำต่อไปนี้

TW

取出刷輓

若要清除刷輓上較粗的線絲或電線，請遵循這些說明：

VIET

Tháo trực bàn chải

Để làm sạch trực bàn chải khỏi sợi chỉ hoặc dây điện dày hơn hãy làm theo các chỉ dẫn sau đây:

- Turn off ULTRAPOWER.
- Pull up the cable protector grill from the locked position, and unlock the brush roll hatch cover. If all steps are followed accordingly the brush roll should be removed easily.
- ULTRAPOWER를 끕니다.
- 케이블 보호 그릴을 위로 올리고, 브러쉬 롤 해치 커버의 잠금을 푸십시오. 모든 절차를 제대로 따르면 브러쉬 롤이 쉽게 분리됩니다.
- Matikan ULTRAPOWER.
- Tarik ke atas kisi-kisi pelindung kabel dari posisi terkunci, dan buka kunci penutup rol sikat. Jika semua langkah diikuti dengan benar, rol sikat akan dapat dilepas dengan mudah.
- 关闭 ULTRAPOWER。
- 从锁定位置拉起线缆保护装置释放架，并将刷辊盖解锁。正确遵循所有步骤后，即可轻松取出刷辊。
- ปิด ULTRAPOWER
- ดึงตะแกรงป้องกันจากตำแหน่งล็อกและปลดล็อกฝาครอบช่องแปรงลูกกลิ้ง หากปฏิบัติตามขั้นตอนนี้ แปรงลูกกลิ้งจะสามารถถอดออกอย่างง่ายดาย
- 關閉 ULTRAPOWER。
- 從鎖定位置拉起滾刷保護裝置釋放架，並解鎖刷輓蓋。正確遵循所有步驟，即可輕鬆取出滾刷。
- Tắt ULTRAPOWER.
- Kéo vỉ bảo vệ cáp khỏi vị trí khóa, và mở khóa nắp nhả trực bàn chải. Nếu làm theo đúng các bước, trực bàn chải sẽ tháo được ra dễ dàng.

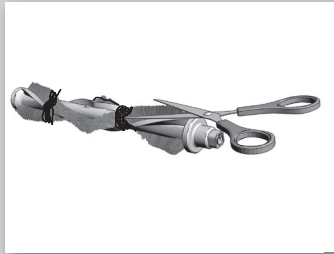

- Use a pair of scissor to remove threads etc.
- Reassemble the brush roll in reverse order making sure it can spin freely
- 실 등을 제거하려면 가위를 사용하십시오.
- 위와 반대 순서로 다시 조립한 후 브러쉬롤이 회전하는지 확인 합니다.
- Gunakan gunting untuk membuang benang dll.
- Pasang rol sikat dengan arah berlawanan untuk memastikan
- 用剪刀去除丝线等杂物。
- 以相反的顺序装回刷辊，确保其能够顺畅转动
- ใช้กรรไกรเพื่อนำเศษด้ายและเศษวัสดุต่าง ๆ ออก
- ประกอบแปรงลูกกลิ้งกลับเข้าที่โดยย้อนลำดับเพื่อให้แน่ใจว่าลูกกลิ้งหมุนได้อิสระ
- 用一把剪刀除去線絲等物
- 以相反的順序將刷棍重組，確保其可自由轉動
- Dùng kéo để loại bỏ sợi chỉ, v.v...
- Lắp ráp lại trục bàn chải theo thứ tự ngược lại và chắc chắn rằng trục này có thể quay tự do

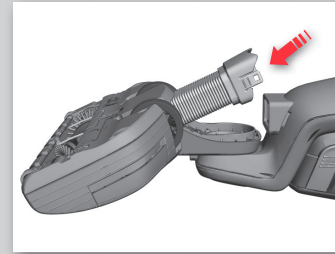

Cleaning the hose and air channel

- Loosen the hose behind the nozzle from its upper connection.
- Remove any object that can be blocking the airflow in the hose or in the air channel to the dust cup, and put the hose back.

호스 및 공기 채널 청소하기

- 노즐 뒤쪽의 호스를 상부 연결 부위에서 풁니다.
- 호스의 공기 순환을 막거나 먼지통의 공기 통로를 막고 있는 물질을 제거한 후 호스를 다시 끼워 넣습니다.

rol dapat berputar

Membersihkan selang dan saluran udara

- Lepaskan selang di belakang nozzle (mulut pipa) dari sambungan di atasnya.
- Keluarkan semua benda yang dapat menghalangi sirkulasi udara di dalam selang atau di saluran udara

清洁软管和空气通道

- 将吸口后方的软管从其上部接口松开。
- 去除软管中或空气通道中可能会阻碍空气流通到集尘杯的任何物体，然后将软管装回。

การทำความสะอาดท่อดูดและช่องอากาศ

- คลายท่อดูดด้านหลังหัวดูดจากส่วนเชื่อมต่อด้านบน
- นำวัตถุที่กีดขวางทางเดินอากาศในท่อดูดหรือในช่องอากาศออกโดยใส่ไว้ในถ้วยรองฝุ่น จากนั้นติดตั้งท่อดูดกลับเข้าที่

清潔軟管與通風道

- 使吸嘴後方的軟管從其上方接合處鬆開。
- 除去任何可能阻礙空氣在軟管或通風道內流至集塵杯的物件，並把軟管放回去。

Làm sạch ống mềm và đường thông khí

- Nới lỏng ống mềm ở phía sau đầu phun ra khỏi khớp nối phía trên.
- Loại bỏ bất kỳ vật gì có thể cản trở luồng khí trong ống mềm hoặc trong đường thông khí tới cốc chứa bụi, và đặt ống mềm trở lại.

EN

KR

IND

CH

TH

TW

VIET

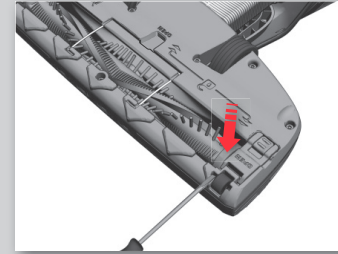
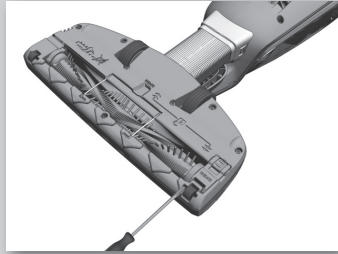

EN

Cleaning the wheels

- If the wheels need to be cleaned or get jammed, remove them carefully by using a flat screwdriver.

KR

바퀴 청소하기

- 바퀴를 청소하거나 바퀴에 무언가 걸려 있는 경우, 일자 드라이버를 사용해 조심스럽게 제거합니다.

IND

menuju tempat debu, dan pasang selang kembali.

Membersihkan roda

- Jika roda perlu dibersihkan atau macet, lepaskan roda secara hati-hati

CH

清潔滾輪

- 如果需要清潔滾輪或滾輪被卡住，請用平螺絲刀小心地將污物去除。

TH

การทำความสะอาดล้อ

- หากต้องทำความสะอาดล้อหรือล้อติดค้าง ให้นำออกอย่างระมัดระวังโดยใช้ไขควง

TW

清潔轉輪

- 如果轉輪卡住或必須清潔，請用平頭螺絲起子將其取下。

VIET

Làm sạch các bánh xe

- Nếu các bánh xe cần được làm sạch hoặc bị tắc, hãy tháo chúng ra cẩn thận bằng cách sử dụng tua vít dẹp.

- Clear the wheel shafts and reassemble the wheels by pressing them back into place.

- 바퀴 축을 청소하고 바퀴를 제자리로 밀어 넣으면서 다시 조립합니다.

menggunakan obeng datar.

- Bersihkan poros roda dan pasang kembali dengan menekannya ke posisi semula.

- 清理輪軸，通過按壓，將滾輪重新裝回原位。

- ทำความสะอาดแกนล้อและประกอบล้อกลับเข้าที่โดยกดล้อเข้าในตำแหน่ง

- 清除輪軸上的髒東西，並將轉輪按壓定位以重組轉輪。

- Làm sạch trục bánh xe và lắp ráp lại các bánh xe bằng cách ấn chúng lại đúng vị trí.

Indication lights – normal operation	What does it mean ?	What to do
1 – 3 Orange lights during operation	3 lights = Battery capacity is still good > 75 % left 2 lights = Battery capacity is still good > 25 % left 1 light = ULTRAPOWER will stop in a few minutes.	OK OK Finish cleaning + charge ULTRAPOWER
Orange light when placed in the charging stand	No problem - ULTRAPOWER is being charged	OK
Orange light blinks slowly every 5 seconds in the charging stand .	No problem – ULTRAPOWER is fully charged.	We recommend to keep ULTRAPOWER in the charging stand after using it. The power consumption in standby is very low

Warning lights	What is the problem	What to do
Orange light blinking + product stops	Battery is empty	Charge ULTRAPOWER.
Red light - blinking	The brush roll is jammed.	Remove the brush roll and clean it manually (see page 24)
Red + Orange light blinking + BRUSH ROLL CLEAN™ function does not work + headlights are turned OFF	The BRUSH ROLL CLEAN™ function has been used for too long time.	Place ULTRAPOWER in the charging stand for 10 minutes to reset the function.
RED light – constant + ULTRAPOWER stops	ULTRAPOWER is overheated or has electrical contact problems.	Clean the filters . Check the hose and nozzle for blockages. Check battery pack connections. If this does not help, please contact a service station.

EN

KR

IND

CH

TH

TW

VIET

표시등 – 정상 작동	무엇을 의미합니까?	무엇을 의미합니까?
작동 중 1 - 3개의 오렌지 등 켜짐	3개 등 = 배터리 용량 양호, 75% 이상 남아있음 2개 등 = 배터리 용량 양호, 25% 이상 남아있음 1개 등 = ULTRAPOWER가 몇 분 안에 멈춥니다.	확인 확인 청소 종료 + ULTRAPOWER 충전
충전 스탠드에 놓여 있는 경우 오렌지 등 켜짐	문제 없음 - ULTRAPOWER가 충전되고 있습니다.	확인
오렌지 등이 충전 스탠드에서 느리게 매 5초마다 깜빡입니다.	문제 없음 - ULTRAPOWER가 완전히 충전되었습니다.	사용한 후에는 ULTRAPOWER를 충전 스탠드에 두시기 바랍니다. 대기 전력 소모는 매우 적습니다.

경고등	문제가 무엇입니까?	무엇을 해야 합니까?
오렌지 등 깜빡임 + 제품 멈춤	배터리가 없습니다.	ULTRAPOWER를 충전하십시오.
적색등 - 깜빡임	브러쉬 롤이 무언가에 걸렸습니다.	브러쉬 롤을 빼서 수동으로 청소합니다(24페이지 참조).
적색 + 오렌지 등 깜빡임 + 브러쉬 자동 청소™ 기능 작동 안 함 + 전조등 꺼짐	브러쉬 자동 청소™ 기능을 너무 오랫동안 사용하였습니다.	충전 스탠드에 ULTRAPOWER를 10분간 놓고 기능을 다시 설정하십시오.
적색등 - 일정하게 유지 + ULTRAPOWER 멈춤	ULTRAPOWER가 과열되었거나 전기 접촉 문제가 있습니다.	필터를 청소합니다. 호스와 노즐이 막혀있는지 확인합니다. 배터리 팩 연결 상태를 확인합니다. 이 문제가 해결 되지 않는 경우, 서비스 센터에 문의하십시오.

	Lampu indikator – pengoperasian normal	Apa artinya?	Yang harus dilakukan
	1 – 3 Lampu oranye selama pengoperasian	3 lampu = Kapasitas baterai masih bagus > 75 % tersisa 2 lampu = Kapasitas baterai masih bagus > 25 % tersisa 1 lampu = ULTRAPOWER akan berhenti beroperasi dalam beberapa menit.	OK OK Pengoperasian selesai + isi daya ULTRAPOWER
	Lampu orange ketika ditempatkan di tempat pengisian daya	Tidak masalah - ULTRAPOWER sedang mengisi daya	OK
	Lampu orange berkedip pelan selama 5 detik di tempat pengisian daya.	Tidak masalah - ULTRAPOWER sudah terisi penuh.	Kami sarankan agar ULTRAPOWER tetap berada di tempat pengisian daya setelah penggunaan. Konsumsi daya pada posisi siaga sangat rendah
EN	Lampu peringatan	Apa masalahnya	Yang harus dilakukan
	Lampu orange berkedip + pengoperasian berhenti	Baterai kosong	Isi daya ULTRAPOWER.
KR	Lampu merah - berkedip	Rol sikat tersumbat.	Lepaskan rol sikat dan bersihkan secara manual (lihat halaman 24)
IND	Lampu Merah + Oranye berkedip + BRUSH ROLL CLEAN tidak berfungsi + lampu utama pada posisi OFF	Fungsi BRUSH ROLL CLEAN™ sudah digunakan terlalu lama.	Tempatkan ULTRAPOWER di tempat pengisian daya selama 10 menit untuk mereset fungsinya.
CH	Lampu MERAH – menyala konstan + ULTRAPOWER berhenti	ULTRAPOWER terlalu panas atau mengalami masalah elektrik.	Bersihkan saringan. Cek selang dan nozzle (mulut pipa) jika tersumbat. Cek sambungan dengan tempat baterai. Hubungi layanan servis jika alat masih tidak berfungsi.
TH			
TW	指示灯 – 正常运作	指示信息	需采取的措施
	运行过程中，1 – 3 盏橙色灯亮起	3 盏灯亮起 = 电池电量仍有充裕，剩余电量 > 75 % 2 盏灯亮起 = 电池电量仍有充裕，剩余电量 > 25 % 1 盏灯亮起 = ULTRAPOWER 将在数分钟内停机。	正常 正常 停止清洁 + 为 ULTRAPOWER 充电
	放置在充电基座上时，橙色灯亮起	正常 - ULTRAPOWER 正在充电	正常
	放置在充电基座上时，橙色灯以每 5 秒一次的速度缓慢闪烁。	正常 - ULTRAPOWER 电已充满。	建议在使用后，将 ULTRAPOWER 一直放置在充电基座中。 待机状态的功耗极低
VIET	警报指示灯	指示问题	需采取的措施
	橙色灯闪烁 + 产品停机	电池耗尽	为 ULTRAPOWER 充电。
	红色灯闪烁	刷辊被卡住。	清理并手动清洁刷辊（请参见第 24 页）。
	红色灯和橙色灯闪烁 + BRUSH ROLL CLEAN™（刷辊清洁）功能无法使用 + 前灯关闭	BRUSH ROLL CLEAN™（刷辊清洁）功能使用时间过长。	将 ULTRAPOWER 放置在充电基座中 10 分钟，以重置该功能。
	红色灯持续亮起 + ULTRAPOWER 停机	ULTRAPOWER 过热或电接触不良。	清洗过滤器。检查软管和吸口是否存在堵塞物。检查电池组连接。如果这些措施不起作用，请联系服务站。

ไฟสัญลักษณ์ - การทำงานปกติ	หมายถึงอะไร	ต้องทำอะไร
ไฟสีส้ม 1-3 ดวงระหว่างการทำงาน	3 ดวง = แบตเตอรี่ยังมีประจุไฟดี > เหลือไฟอีก 75% 2 ดวง = แบตเตอรี่ยังมีประจุไฟดี > เหลือไฟอีก 25% 1 ดวง = ULTRAPOWER จะหยุดทำงานในไม่ช้า	ปกติ ปกติ สิ้นสุดการทำความสะอาด + ชาร์จ ULTRAPOWER
ไฟสีส้มเมื่อวางไว้บนฐานชาร์จ	ไม่มีปัญหา - กำลังชาร์จ ULTRAPOWER	ปกติ
ไฟสีส้มติดกะพริบซ้ำ ๆ ทุก 5 วินาทีที่ฐานชาร์จ	ไม่มีปัญหา - ULTRAPOWER ชาร์จไฟเต็มแล้ว	ขอแนะนำให้วาง ULTRAPOWER บนฐานชาร์จกลับใช้งาน อัตราสิ้นเปลืองพลังงานในโหมดสแตนด์บายอยู่ในระดับต่ำมาก
ไฟแจ้งเตือน	มีปัญหาอะไร	ต้องทำอะไร
ไฟสีส้มติดกะพริบ + เครื่องหยุดทำงาน	แบตเตอรี่หมดประจุ	ชาร์จ ULTRAPOWER
ไฟสีแดง - กะพริบ	แปรงลูกกลิ้งติดค้าง	ถอดแปรงลูกกลิ้งและทำความสะอาดด้วยตัวเอง (ดูในหน้า 24)
ไฟสีแดง + สีส้มติดกะพริบ + ฟังก์ชัน BRUSH ROLL CLEAN ไม่ทำงาน + ไฟด้านหลังไม่ติดสว่าง	ฟังก์ชัน BRUSH ROLL CLEAN ใช้งานนานเกินไป	วาง ULTRAPOWER บนฐานชาร์จเป็นเวลา 10 นาทีเพื่อรีเซ็ตฟังก์ชัน
ไฟสีแดง - ติดค้าง + ULTRAPOWER หยุดทำงาน	ULTRAPOWER มีความร้อนเกินหรือมีปัญหาที่หน้าสัมผัสทางไฟฟ้า	ทำความสะอาดที่กรอง ตรวจสอบท่อดูดและหัวดูดว่ามีสิ่งอุดตันหรือไม่ ตรวจสอบการเชื่อมต่อของแบตเตอรี่ หากไม่สามารถแก้ไขปัญหาได้ กรุณาติดต่อศูนย์บริการ

EN

KR

IND

CH

TH

TW

VIET

指示灯 - 一般操作	其意義為何?	如何處理
操作時亮 1 至 3 個橙色燈	3 個燈 = 電量仍舊充足, 剩下電力 > 75% 2 個燈 = 電量仍舊充足, 剩下電力 > 25% 1 個燈 = ULTRAPOWER 將於幾分鐘後停止。	沒有問題 沒有問題 完成清潔工作 + 對 ULTRAPOWER 充電
放在充電座時亮橙色燈	沒有問題 - ULTRAPOWER 正在充電	沒有問題
在充電座時, 橙色燈緩慢地每五秒閃一次燈。	沒有問題 - ULTRAPOWER 已經充電。	我們建議於使用後把 ULTRAPOWER 留置在充電座中。 待機模式的耗電量非常低

警示燈	問題描述	如何處理
橙色燈閃爍 + 產品停止	電池電量耗盡	對 ULTRAPOWER 充電。
紅燈 - 閃爍	刷輓卡住了。	把刷輓取下並手動清潔 (請看第 24 頁)
紅燈 + 橙色燈閃爍 + BRUSH ROLL CLEAN 功能無法使用 + 頭燈呈關閉狀態	BRUSH ROLL CLEAN 功能使用時間過長。	將 ULTRAPOWER 放在充電座 10 分鐘以重設此功能。
紅燈 - 持續 + ULTRAPOWER 停止	ULTRAPOWER 過熱或發生電氣接觸問題。	清潔過濾器。檢查軟管與吸嘴是否堵塞。檢查電池組連接情況。如果上述方法不能解決問題, 請聯絡服務站。

Đèn chỉ báo – hoạt động bình thường	Điều này có nghĩa là gì ?	Những điều cần làm
1 – 3 Các đèn màu cam trong khi hoạt động	3 đèn = Dung lượng pin vẫn tốt còn lại > 75 % 2 đèn = Dung lượng pin vẫn tốt còn lại > 25 % 1 đèn = ULTRAPOWER sẽ dừng hoạt động trong vài phút nữa.	OK OK Hoàn thành việc làm sạch + sạc ULTRAPOWER
Đèn màu cam khi được đặt ở để sạc	Không vấn đề gì - ULTRAPOWER đang được sạc điện	OK
Đèn màu cam nhấp nháy chậm cứ 5 giây một lần trong để sạc .	Không vấn đề gì – ULTRAPOWER đã được sạc đầy.	Chúng tôi khuyên bạn nên để ULTRAPOWER trong để sạc sau khi sử dụng. Việc tiêu thụ điện ở chế độ chờ là rất thấp

Đèn cảnh báo	Vấn đề là gì	Những điều cần làm
Đèn màu cam nhấp nháy + máy dừng hoạt động	Hết pin	Sạc ULTRAPOWER.
Đèn màu đỏ – nhấp nháy	Trục bàn chải bị kẹt.	Tháo trục bàn chải ra và làm sạch bằng tay (xem trang 24)
Đèn màu Đỏ + Cam nhấp nháy + chức năng BRUSH ROLL CLEAN không hoạt động + đèn trước được TẮT	Chức năng BRUSH ROLL CLEAN™ đã được sử dụng trong thời gian quá lâu	Đặt ULTRAPOWER trong để sạc trong 10 phút để khởi động lại chức năng này.
Đèn ĐỎ – liên tục + ULTRAPOWER ngừng hoạt động	ULTRAPOWER bị quá nhiệt hoặc gặp sự cố tiếp xúc điện.	Vệ sinh các bộ lọc . Kiểm tra ống mềm và đầu phun để xem có bị tắc không. Kiểm tra các khớp nối ngăn chứa pin. Nếu điều này không giúp ích gì, vui lòng liên hệ với trạm dịch vụ.

EN

KR

IND

CH

TH

TW

VIET

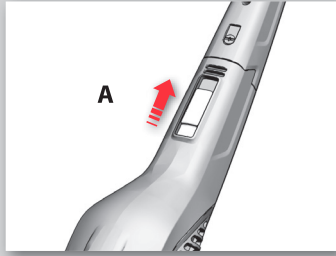

The battery pack

ULTRAPOWER is equipped with a detachable battery pack. Before releasing the pack, make sure that ULTRAPOWER is in the OFF position.

To release the battery pack lift the battery pack hatch upwards.

Warning : Improper handling of the battery pack may be hazardous.

- Never dispose the battery pack with household waste. If the battery pack is damaged or malfunctioning it should be disposed at recycling station for batteries.
- Never use the battery pack for purposes other than ULTRAPOWER.
- Do not expose the battery pack to heat, outdoor or wet conditions.
- When removing the battery pack keep it away from other metal objects like metal surfaces, paper clips, coins, keys, nails, screws, or other metal objects. Short circuiting the battery terminals may cause thermal effects, smoke, sparks, burns or fire.
- ULTRAPOWER is available in 2 different voltages: 21.6V and 25.2V, both with Lithium batteries (In specific markets). It is not possible to fit a battery pack with a different voltage other than the one specified for each model.

Ultrapower has advanced electronics to optimize the performance and life of the battery. Therefore please recharge Ultrapower for 24 hours before using it for the first time.

Extra battery pack

If you need longer run time, you can buy an extra battery pack (available in some markets).

배터리 팩

ULTRAPOWER에는 분리 가능한 배터리 팩이 장착되어 있습니다. 팩을 분리하기 전에, ULTRAPOWER가 꺼져 있는지 확인합니다.

배터리 팩을 분리하려면, 배터리 팩 분리 버튼을 위쪽으로 당겨 올립니다.

경고: 배터리 팩을 부적절하게 사용하는 것은 위험합니다.

- 사용한 배터리 팩은 가정용 폐기물과 함께 버리지 않습니다. 배터리 팩이 손상되거나 제대로 작동하지 않는 경우, 배터리 재활용 수거함에 버리십시오.
- ULTRAPOWER의 용도 외에 배터리 팩을 사용하지 마십시오.
- 배터리 팩을 열원, 야외 또는 습기가 많은 곳에 두지 마십시오.
- 배터리 팩을 제거할 때, 주변에 금속 표면, 종이 클립, 동전, 열쇠, 못, 나사, 등과 같은 금속 물체가 없도록 합니다. 배터리 단자가 단락되면 열효과, 연기, 불꽃, 연소 또는 화재 등이 발생할 수 있습니다.
- 어린이가 배터리팩을 가지고 놀지 않도록 주의하십시오.
- 배터리팩에 충격을 주지 않도록 주의하십시오.
- ULTRAPOWER는 21.6V 및 25.2V의 서로다른 2가지 전압 모델이 판매되며 두 가지 모두 리튬 배터리입니다(특정 국가에 한함). 모델별로 지정된 것과 다른 전압을 가진 배터리 팩은 사용할 수 없습니다.

ULTRAPOWER는 최신 전자 기술을 사용해 배터리의 성능과 수명을 최적화했습니다. 따라서, 최초에 사용하기 전에 ULTRAPOWER를 24시간 동안 충전하십시오.

추가 배터리 팩

작동 시간을 늘리고 싶으시면, 추가 배터리 팩을 구매하십시오.

EN

KR

IND

CH

TH

TW

VIET

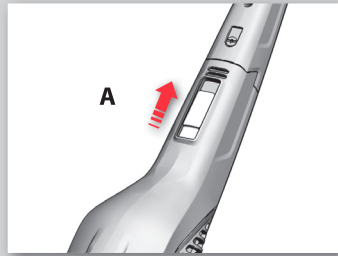

EN

Baterai

ULTRAPOWER dilengkapi dengan baterai yang dapat dilepaskan. Sebelum melepas baterai, pastikan ULTRAPOWER dalam posisi MATI.

KR

Angkat baterai ke atas untuk melepaskan.

Peringatan : Penanganan baterai yang tidak benar dapat membahayakan.

IND

- Jangan membuang baterai bersama dengan limbah rumah tangga. Baterai yang rusak atau tidak berfungsi harus dibuang di tempat daur ulang untuk baterai.

CH

- Jangan gunakan baterai untuk penggunaan selain ULTRAPOWER.
- Hindarkan baterai dari panas, kondisi luar ruangan atau basah.

TH

- Jauhkan benda logam seperti permukaan logam, klip kertas, koin, kunci, paku, sekrup, atau benda logam lain ketika melepaskan baterai. Hubungan pendek dalam terminal baterai dapat menimbulkan efek panas, asap, percikan, luka bakar atau api.

TW

- ULTRAPOWER tersedia dengan 2 voltase berbeda: 21,6V dan 25,2V, keduanya dengan baterai Litium (Di pasar tertentu). Baterai dengan voltase yang berbeda dengan yang ditetapkan untuk masing-masing model tidak akan dapat dipasang.

VIET

Ultrapower memiliki teknologi yang maju untuk mengoptimalkan kinerja dan masa pakai baterai. Harap isi baterai Ultrapower selama 24 jam sebelum digunakan untuk pertama kali.

Baterai ekstra

Jika Anda ingin pengoperasian yang lebih lama, Anda dapat membeli baterai ekstra (tersedia dipasaran tertentu). Baterai ekstra dilengkapi dengan stasiun pengisian daya terpisah yang terhubung dengan tempat pengisian daya ULTRAPOWER, sehingga Anda dapat mengisi daya baterai pada saat bersamaan.

电池组

ULTRAPOWER 配有可拆卸式电池组。取出电池组之前，请确保 ULTRAPOWER 处于关机状态。

要取出电池组，请向上提起电池组门。

警告：对电池组的处理不当可能会带来危险。

- 切勿将使用过的电池组与生活垃圾一起弃置。如果电池组受损或故障，应将其送至回收电池的回收站进行处理。

- 切勿将电池组用于 ULTRAPOWER 以外的其他用途。

- 请勿将电池组暴露于高温、室外或潮湿条件下。

- 拆除电池组时，确保其远离其他金属物体（例如，金属表面、回形针、硬币、钥匙、钉子、螺钉或其他金属物体）。电池端子短路可能导致热效应、冒烟、发出火花、起火或燃烧。

- ULTRAPOWER 可用于 2 种不同的电压环境：21.6V 和 25.2V 锂电池（某些市场中）。不得为 ULTRAPOWER 安装电压与型号规定不同的电池组。

Ultrapower 配有先进的电子器件，可优化电池的性能和续航时间。因此，首次使用 Ultrapower 之前，请先重新为其进行 24 小时的充电。

备用电池组

如果需要延长运行时间，可购买备用电池组（某些市场中有售）。

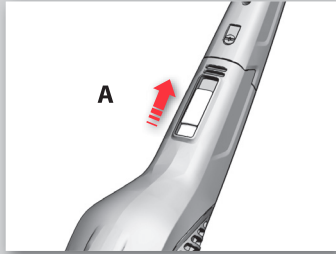

ชุดแบตเตอรี่

ULTRAPOWER ติดตั้งมาพร้อมกับชุดแบตเตอรี่แบบถอดได้ ก่อนนำแบตเตอรี่ออก ให้ตรวจสอบว่า ULTRAPOWER อยู่ในตำแหน่ง OFF

นำชุดแบตเตอรี่ออกโดยยกฝาปิดแบตเตอรี่ขึ้น

คำเตือน: การใช้งานแบตเตอรี่อย่างไม่ถูกต้องอาจทำให้เกิดอันตรายได้

- อย่าทิ้งแบตเตอรี่ร่วมกับขยะในครัวเรือน หากแบตเตอรี่เสียหายหรือทำงานผิดพลาด ให้ทิ้งกับศูนย์รีไซเคิลแบตเตอรี่
- อย่าใช้แบตเตอรี่กับอุปกรณ์อื่นนอกเหนือจาก ULTRAPOWER
- อย่าให้แบตเตอรี่โดนความร้อน ทั้งแบตเตอรี่ไว้ในที่แจ้งหรือในที่เปียกชื้น
- ขณะถอดแบตเตอรี่ ให้แยกแบตเตอรี่จากวัตถุโลหะอื่น ๆ คลิปหนีบกระดาษ เหรียญ กุญแจ ตะปูหรือสกรู การลัดวงจรที่ขั้วแบตเตอรี่อาจทำให้เกิดความร้อน คว้น ประกายไฟ หรือเพลิงไหม้ได้
- ULTRAPOWER มี 2 รุ่น โดยมีขนาดแรงดันไฟฟ้า 21.6V และ 25.2V (ขึ้นอยู่กับแต่ละประเทศ) ซึ่งใช้แบตเตอรี่ Lithium ชุดแบตเตอรี่ที่มีพิกัดแรงดันไฟแตกต่างกันไม่สามารถประกอบกันได้

Ultrapower มีระบบอิเล็กทรอนิกส์ที่ซับซ้อนเพื่อรองรับประสิทธิภาพในการทำงานและอายุการใช้งานของแบตเตอรี่ ดังนั้นขอแนะนำให้ชาร์จ Ultrapower เป็นเวลา 24 ชั่วโมงก่อนใช้งานเป็นครั้งแรก

ชุดแบตเตอรี่เสริม

หากต้องการใช้งานเป็นเวลายาวนาน สามารถซื้อแบตเตอรี่เสริม (มีจำหน่ายในบางแห่งเท่านั้น) ชุดแบตเตอรี่เสริม จำหน่ายพร้อมชุดชาร์จไฟแยกเฉพาะที่สามารถเชื่อมต่อกับฐานชาร์จ ULTRAPOWER เพื่อให้คุณสามารถชาร์จแบตเตอรี่ทั้งสองชุดได้พร้อมกัน

แบตเตอรี่

ULTRAPOWER 備有一个可移除的电池组。在取下电池组之前，请确保 ULTRAPOWER 是在关闭 (OFF) 的状态。

把电池组舱盖向上拉起以取出电池组。

警告：电池组处理不当可能造成危险。

- 切勿将用过的电池组与家用废弃物一起丢弃。若电池组受到损害或功能不正常，则应将其交给电池回收站处理。
- 绝对不可在 ULTRAPOWER 以外的用途中使用电池组。
- 不可以使电池组暴露于高温、室外或潮湿的环境。
- 移除电池组时，将其远离其它金属制品，如金属面、纸夹、硬币、钥匙、铁钉、螺丝或其他金属物。将电池接线柱短路将造成热效应、烟雾、火花、烧焦或燃烧。
- ULTRAPOWER 有 2 种不同的电压：21.6V 和 25.2V 锂电池（在某些市场販售）。不得为 ULTRAPOWER 安装与电压与型号规定不同的电池组。

Ultrapower 採用先進的電子零件以增強電池的效能與壽命。因此，請在第一次使用 Ultrapower 之前先行充電 24 小時。

額外電池組

如果您需要更長的使用時間，可以買一個額外的電池組（可在某些市場購得）。

EN

KR

IND

CH

TH

TW

VIET

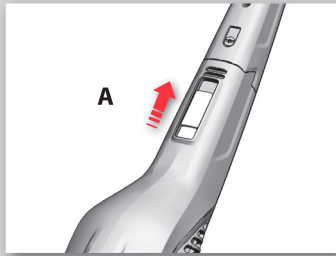

EN

Ngăn chứa pin

ULTRAPOWER được trang bị ngăn chứa pin tháo rời được. Trước khi tháo ngăn chứa pin ra, hãy chắc rằng ULTRAPOWER ở vị trí TẮT.

KR

Để tháo ngăn chứa pin ra hãy nâng nắp ngăn chứa pin lên.

Cảnh báo : Nếu xử lý ngăn chứa pin không đúng cách thì có thể gây nguy hiểm.

IND

- Không bao giờ vứt ngăn chứa pin đã dùng cùng rác thải gia đình. Nếu ngăn chứa pin bị hỏng hoặc gặp sự cố, nó nên được xử lý tại cơ sở tái chế pin.

CH

- Không bao giờ sử dụng ngăn chứa pin cho các mục đích không phải là ULTRAPOWER.

- Không để ngăn chứa pin tiếp xúc với nhiệt, điều kiện ngoài trời hoặc ẩm ướt.

TH

- Khi tháo ngăn chứa pin hãy để tránh xa khỏi các vật kim loại khác như các bề mặt kim loại, ghim giấy, nệm, chìa khóa, đinh, ốc vít hoặc các vật kim loại khác. Sự cố đoản mạch cực pin có thể gây hiệu ứng nhiệt, khói, tia lửa, bỏng hoặc cháy.

TW

- Pin sử dụng cho ULTRAPOWER 21,6V và 25,2V, cả hai đều là pin Lithium (ở một số thị trường). Không thể lắp pin có mức điện áp khác với mức điện áp được quy định cho từng model.

VIET

Ultrapower có thiết bị điện tử cao cấp để tối ưu hóa hiệu suất và tuổi thọ của pin . Do đó vui lòng sạc lại Ultrapower trong 24 giờ trước khi sử dụng lần đầu tiên.

Ngăn chứa pin phụ

Nếu quý vị cần thời gian chạy lâu hơn, quý vị có thể mua ngăn chứa pin phụ (sẵn có trong một số thị trường). Ngăn chứa pin phụ đi kèm với bộ để sạc riêng nối với bộ sạc của ULTRAPOWER để quý vị có thể sạc cả hai ngăn chứa pin cùng một lúc.

Consumer information

Servicing or repairs

In cases of breakdown or faults, your ULTRAPOWER must be taken to an authorized Electrolux service centre.

If the supply cord or charger is damaged, it must be replaced by Electrolux or its service agent or an equally qualified person in order to avoid a hazard.

Batteries are components with limited lifetime. Their life time can vary depending on conditions of use, storage, weather and maintenance.

Consumer information

Electrolux declines all responsibility for all damages arising from any improper use of the appliance or in cases of tampering with the appliance.

This product is designed with the environment in mind. All plastic parts are marked for recycling purposes.

For details see our web site: www.electrolux.com

We declare that this battery-operated vacuum cleaner, intended for domestic use, conforms to the EMC Directive 2004/108/EC, Low Voltage Directive 2006/95/EC and the CE marking Directive 93/68/EEC. All conformity testing has been done by an independent third party testing body.

소비자 정보

소비자 정보

고장이나 제품에 이상이 발견되면 반드시 ULTRAPOWER 제품을 공식 Electrolux 서비스 센터로 가져가시기 바랍니다.

전원 코드 및 충전기가 손상된 경우 위험을 방지하려면 Electrolux, 서비스 대리점 또는 동등한 자격을 갖춘 전문가가 교환해야 합니다.

배터리는 수명이 제한되어 있는 소모품입니다. 배터리의 수명은 사용, 보관, 날씨 및 유지보수 조건에 따라 달라질 수 있습니다.

소비자 정보

제품을 부적절하게 사용하거나 함부로 만져서 발생하는 모든 파손에 대해서 Electrolux는 일체의 책임을 지지 않습니다.

본 제품은 환경 보호를 고려하여 설계했습니다. 제품의 모든 플라스틱 부분에는 재활용 표시가 되어 있습니다.

자세한 사항은 다음의 Electrolux 홈페이지에서 확인하실 수 있습니다. www.electrolux.com

본 배터리 작동 진공 청소기는 가정용으로 제작되었으며, EMC 지침 2004/108/EC, 저전압 지침 2006/95/EC 및 CE 표시 지침 93/68/EEC를 준수합니다. 준수 여부는 외부 독립 시험 기관에서 시험했습니다.

Informasi bagi konsumen

Servis atau reparasi

Apabila alat rusak atau tidak dapat berfungsi, ULTRAPOWER harus dibawa ke pusat servis resmi Electrolux.

Jika kabel listrik atau alat pengisi daya rusak, penggantian hanya boleh dilakukan oleh Electrolux, agen servis atau orang yang memiliki kualifikasi serupa untuk menghindari bahaya.

Baterai merupakan komponen dengan usia pakai terbatas. Usia pakainya dapat berbeda-beda tergantung pada kondisi penggunaan, penyimpanan, cuaca, dan pemeliharaan.

Informasi bagi konsumen

Electrolux tidak bertanggung jawab atas segala kerusakan yang timbul karena kesalahan penggunaan alat atau apabila terjadi gangguan pada alat.

Produk ini didesain dengan mempedulikan lingkungan. Semua komponen plastik memiliki tanda dapat didaur ulang.

Untuk rincian, kunjungi situs web kami: www.electrolux.com

Kami menyatakan bahwa pengoperasian baterai ini untuk pengisap debu, ditujukan untuk penggunaan rumah tangga, menurut Peraturan EMC (EMC Directive) 2004/108/EC, Peraturan Voltase Rendah (Low Voltage Directive) 2006/95/EC dan Peraturan tanda CE (CE marking Directive) 93/68/EEC. Semua uji kenyamanan telah dilakukan oleh badan pengujian pihak ketiga yang independen.

用户须知

服务或维修

您的 ULTRAPOWER 如遇到故障或存在问题，必须送至伊莱克斯授权的服务中心。

如果电源线或充电器损坏，必须由伊莱克斯或其维修代理或具备同等资质的人员进行更换，以免发生危险。

电池组件的使用寿命有限，并取决于使用、存储、天气和维护条件。

用户须知

对于因不当使用或擅自改动本器具而引起的任何损害，伊莱克斯不承担任何责任。

本产品在设计时融入了环保理念。所有塑料部件均进行了标识以便于回收。

有关详细信息，请访问我们的网站：www.electrolux.com

我们郑重声明：供家庭使用的本款电池供电的吸尘器，符合 EMC 指令 2004/108/EC、低电压指令 2006/95/EC 以及 CE 标志指令 93/68/EEC。所有合规性测试，均已由独立第三方测试机构完成。

EN

KR

IND

CH

TH

TW

VIET

ข้อมูลผู้บริโภค**การบริการหรือซ่อมแซม**

ในกรณีที่อุปกรณ์เสียหายหรือมีข้อบกพร่อง จะต้องนำ ULTRAPOWER ไปยังศูนย์บริการของ Electrolux

หากอุปกรณ์หรือสายไฟเสียหาย ให้ส่งซ่อมกับ Electrolux ตัวแทนให้บริการหรือนักลกรผู้เชี่ยวชาญเพื่อป้องกันอันตรายที่อาจเกิดขึ้น

แบตเตอรี่เป็นส่วนประกอบที่มีอายุการใช้งานจำกัด ทั้งนี้ อายุการใช้งานอาจแตกต่างกันไปตามสภาพการใช้งาน การจัดเก็บ สภาพอากาศ และการบำรุงรักษา

ข้อมูลผู้บริโภค

EN

Electrolux ปฏิเสธความรับผิดชอบทั้งหมดสำหรับความเสียหายใด ๆ ที่เกิดขึ้นจากการใช้อุปกรณ์อย่างไม่เหมาะสมหรือการตั้งและอุปกรณ์

KR

ผลิตภัณฑ์นี้ได้รับการออกแบบโดยคำนึงถึงสิ่งแวดล้อม ชิ้นส่วนพลาสติกทั้งหมดถูกทำเครื่องหมายเพื่อจุดประสงค์ในการรีไซเคิล

IND

ดูรายละเอียดที่เว็บไซต์ของเรา: www.electrolux.com

เครื่องดูดฝุ่นแบบใช้แบตเตอรี่นี้ผลิตขึ้นสำหรับใช้ในครัวเรือนและได้มาตรฐาน EMC Directive 2004/108/EC, Low Voltage Directive 2006/95/EC และ CE marking Directive 93/68/EEC. การทดสอบการรองรับการทำงานภายใต้มาตรฐานที่กำหนดดำเนินการโดยหน่วยงานตรวจสอบภายนอก

CH

TH

消費者資訊**維護或修理**

在發生停機或故障時，您必須將 ULTRAPOWER 送往授權的 Electrolux 服務中心。

如果電源線或充電器已損壞，則必須由 Electrolux 或是其維修代理商，或類似的合格人員更換，以避免發生危險。

電池組件的使用壽命有限，取決於使用方式、儲存環境條件、天氣和維護方式。

消費者資訊

若因不當使用此機具或將其改造而造成的損害，Electrolux 概不負任何責任。

此產品在設計時便已考慮環保因素。所有的塑膠零件皆打上回收標示。

如需詳細資訊，請至我們的網站：www.electrolux.com

我們在此聲明此電池供電式家用吸塵器符合 EMC Directive 2004/108/EC, 低電壓指令 2006/95/EC 與 CE 標示指令 93/68/EEC 的規定。所有的符合性測試皆由獨立的第三方測試團體完成。

Thông tin người tiêu dùng**Bảo dưỡng hoặc sửa chữa**

Trong trường hợp trục trặc hay hỏng hóc, phải mang ULTRAPOWER của bạn đến một trung tâm dịch vụ được ủy quyền của Electrolux.

Nếu dây cấp nguồn hay bộ sạc bị hư hại, nó phải được thay thế bởi Electrolux hoặc đại lý dịch vụ của Electrolux hoặc một người có đủ trình độ tương đương để tránh nguy hiểm.

Pin là bộ phận có tuổi thọ giới hạn. Tuổi thọ của pin tùy thuộc vào điều kiện sử dụng, cách bảo quản, thời tiết và bảo trì.

Thông tin người tiêu dùng

Electrolux khước từ mọi trách nhiệm về mọi hư hỏng phát sinh do sử dụng thiết bị không đúng cách hoặc trong các trường hợp phá hoại thiết bị này.

Sản phẩm này được thiết kế có quan tâm đến bảo vệ môi trường. Mọi bộ phận nhựa đều được đánh dấu cho các mục đích tái chế.

Để biết thông tin chi tiết, xem trang web của chúng tôi: www.electrolux.vn

Chúng tôi xin tuyên bố rằng máy hút bụi hoạt động bằng pin này được dự định cho việc sử dụng trong nhà, tuân thủ theo Chỉ Thị EMC 2004/108/EC, Chỉ Thị 2006/95/EC về Điện Áp Thấp và Chỉ Thị CE 93/68/EEC về ghi nhãn. Tất cả việc thử nghiệm về sự phù hợp đều đã được một cơ quan thử nghiệm bên thứ ba độc lập thực hiện.



The symbol  on the product or on its packaging indicates that this product may not be treated as household waste. Instead it shall be handed over to the applicable collection point for the recycling of electrical and electronic equipment. By ensuring this product is disposed of correctly, you will help prevent

and human health, which could otherwise be caused by inappropriate waste handling of this product. For more detailed information about recycling of this product, please contact your local city office, your household waste disposal service or the shop where you purchased the product.



제품 또는 포장 박스의  표시는 이 제품을 일반 가정용 폐기물로 처리해서는 안됨을 나타냅니다. 이러한 제품은 전기 또는 전자 제품의 재활용 수거 센터로 인도해야 합니다. 이 제품의 올바른 폐기는 부적합한 폐기물 처리로 인해 발생할 수 있는 환경 및 인체 건강에 대한 부정적 결과를 예방하는 데 도움이 됩니다. 이 제품의 재활용에 대한 자세한 정보는 해당 지역 동사무소나 가까운 가정용 폐기물 처리 센터 또는 제품 구매처로 문의하시기 바랍니다.



Tanda  pada produk atau paket menandakan bahwa produk ini bukan merupakan limbah rumah tangga. Produk ini harus dibawa ke tempat pengumpulan untuk alat-alat listrik yang dapat didaur-ulang. Dengan membuang produk ini secara benar, anda membantu mencegah dampak buruk pada lingkungan dan kesehatan manusia, yang dapat diakibatkan oleh penanganan limbah produk ini yang salah. Untuk keterangan lebih lanjut akan produk ini, silahkan hubungi bagian tata kota, layanan pembuangan limbah atau toko dimana anda membeli produk ini.



产品上或其包装上的  标记表示不能把该产品作为家庭垃圾般处理。应该将其弃置在电气和电子设备的废品回收站点。

为了确保本品得到正确弃置和避免由于不适当处理废品而给环境和人类健康带来潜在的负面效果,您也可以尽一分力。对于本品回收的更详细信息,请联系您当地的废物回收部门、您的家庭垃圾处理服务点或您产品的商店。



สัญลักษณ์  ที่กำกับอยู่บนผลิตภัณฑ์หรือบรรจุภัณฑ์แสดงว่าท่านไม่สามารถทิ้งผลิตภัณฑ์ดังกล่าวร่วมกับขยะครัวเรือนได้ และควรนำส่งศูนย์รวบรวมเครื่องใช้ไฟฟ้าและอุปกรณ์อิเล็กทรอนิกส์ เพื่อผ่านกระบวนการนำกลับมาใช้ใหม่ การทิ้งผลิตภัณฑ์นี้โดยไม่ถูกต้องจะช่วยลดผลกระทบที่มีต่อสุขภาพแวดล้อมและสุขอนามัยหากท่านทิ้งผลิตภัณฑ์นี้โดยไม่ถูกต้องเหมาะสม จะก่อให้เกิดผลเสียต่อสุขภาพแวดล้อมและสุขอนามัย หากท่านต้องการข้อมูลเพิ่มเติมเกี่ยวกับกระบวนการนำผลิตภัณฑ์นี้กลับมาใช้ใหม่ โปรดติดต่อสอบถามจากหน่วยงานที่มีหน้าที่รับผิดชอบในท้องถิ่นของท่าน, ศูนย์บริการจัดเก็บขยะในครัวเรือน หรือร้านค้าที่ท่านซื้อผลิตภัณฑ์ของท่าน



产品上或其包装上的  标记表示不能把该产品作为家庭垃圾般处理。应该将其弃置在电气和电子设备的废品回收站点。

为了确保本品得到正确弃置和避免由于不适当处理废品而给环境和人类健康带来潜在的负面效果,您也可以尽一分力。对于本品回收的更详细信息,请联系您当地的废物回收部门、您的家庭垃圾处理服务点或您产品的商店。



Biểu tượng  trên sản phẩm hoặc trên bao bì của sản phẩm chỉ ra rằng sản phẩm này không thể được coi là phế thải gia dụng. Thay vào đó, sản phẩm sẽ được giao đến điểm thu phế liệu phù hợp để tái chế cho các dụng cụ điện và điện tử.

Khi đảm bảo rằng sản phẩm này được phế thải một cách hợp lý, quý vị sẽ giúp tránh được khả năng xảy ra những hậu quả xấu cho môi sinh và sức khỏe con người mà nếu xử lý thải bỏ không phù hợp sẽ gây ra. Để biết thông tin chi tiết hơn về cách tái chế cho sản phẩm này, xin vui lòng liên hệ với văn phòng thị pháp địa phương của quý vị, dịch vụ phế thải gia dụng hoặc cửa hàng bạn đã mua sản phẩm này.

www.electrolux.com/shop



ultrapower™

21,6V
25,2V



Share more of our thinking at www.electrolux.com

2015_APAC_ULTRAPOWER_IFU_V1