



# Instruction Book

## PUREi9

GB INSTRUCTION BOOK  
CS 说明书

CT 說明手冊  
ID BUKU PETUNJUK

KO 사용 설명서  
TH คู่มือการใช้งาน

VI SÁCH HƯỚNG DẪN

### Safety precautions

This appliance can be used by children aged from 8 years and above and persons with reduced physical, sensory or mental capabilities or lack of experience and knowledge if they have been given supervision or instruction concerning use of the appliance in a safe way and understand the hazards involved.

The robot should only be used for normal vacuuming in a domestic/indoor environment.

Make sure the robot is stored in a dry place.

*All service or repairs must be carried out by an authorized Electrolux service centre.*

Remove the robot from the charger before cleaning or maintaining your robot.

Do not allow children to play with the appliance.

Packaging material, e.g. plastic or fabric bags should not be accessible to children to avoid suffocation.

The robot is designed for a specific voltage. Check that your supply voltage is the same as that stated on the rating plate on the charging adaptor.

Use only the original charging station and adaptor designed for the robot.

#### Never use the robot:

- In wet areas.
- Close to flammable gases, etc.
- When the product shows visible signs of damage.
- On sharp objects or fluids.
- On hot or cold ashes, lighted cigarette butts, etc.
- On fine dust, for instance from plaster, concrete, flour, hot or cold ashes.
- Do not leave the robot in direct sunlight.
- Avoid exposing the robot to strong heat.
- The battery pack within must not be dismantled, short circuited or placed against a metal surface. Use only the battery pack designed for the robot.
- Batteries must be removed from the appliance before it is disposed of.

- The appliance must not be plugged in when removing the battery.
- The battery is to be disposed of safely.
- Never use the robot without filter.
- Do not touch the brush roll while the cleaner is switched on and the brush roll is turning. Do not touch the wheels while the robot is operating.

Using the robot in a manner that conflicts with above recommendations may cause serious personal injury or damage to the product. Such injury or damage is not covered by the warranty or by Electrolux.

The warranty does not cover reduction in battery runtime due to battery age or use, as the life of the battery depends upon the length and number of times the robot is used.

Before cleaning, remove small and fragile objects such as clothing, curtain strings, papers and power cords from the floor. If the device passes over a power cord and pulls it, there is a risk that an object could be pulled off a table or shelf.

The robot is designed to not move any larger objects in its way. Objects such as chairs can therefore be left on the floor as the robot will clean around them.

Strong light, mirrored walls, floor-to-ceiling windows and very shining objects could disturb the 3D Vision system.

#### Visit our website to:



Get usage advice, brochures, trouble shooter, service information:  
**[www.electrolux.com](http://www.electrolux.com)**



Register your product for better service:  
**[www.electrolux.com/productregistration](http://www.electrolux.com/productregistration)**



Buy Accessories and Consumables for your appliance:  
**[www.electrolux.com/shop](http://www.electrolux.com/shop)**

## Recommended operation, charging and storage environment for Electrolux battery products

### 1. Operation, charging and storage conditions

This product is intended to be used in normal household environment and should not be exposed to abnormal temperature.

To protect the internal parts of product it should not be stored, charged or operated in:

- An ambient temperature below 10 °C or exceeding 30 °C.
- If the product is stored in temperature below 10 °C or exceeding 30 °C. Please wait a few hours so that the internal components of the products can cool down or warm up and dry before usage. Usage and storage outside temperature interval might harm the product or reduce lifetime.
- Below 20% or over 80% humidity levels (Non-Condensing)

Charge the product for minimum 24 hours:

- Before first use.
- Before storage for a longer time period. (Remove batteries from the robot before long time storage.)
- After storage for a longer time period.

### 2. Dew condensation warning

Dew condensation may form inside the product under the following conditions:

- The unit is moved from a cold to a warm place.
- Under conditions of very high humidity.
- After heating a cold room.

Please wait a few hours for the internal components of the products to warm up and dry before usage.

### 3. To preserve the battery life and performance:

- Always keep the robot charging when not in use.
- Charge it as soon as possible after the cleaning cycle. Waiting too long might affect the batteries.

## Environmental concerns



This symbol on the product indicates that this product contains a built-in rechargeable battery which shall not be disposed with normal household waste.



This symbol on the product or on its packaging indicates that the product may not be treated as household waste. To recycle your product, please take it to an official collection point or to an Electrolux service center that can remove and recycle the battery and electric parts in a safe and professional way. Follow your country's rules for the separate collection of electrical products and rechargeable batteries.

## Customer care and service

When contacting the Electrolux service center, ensure that you have following data available:

- Model number
- PNC number
- Serial number

The information can be found on the rating plate.

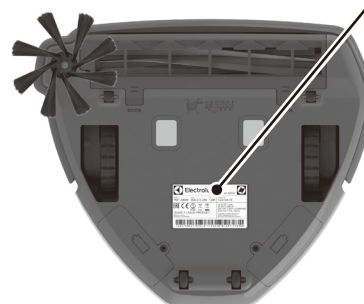
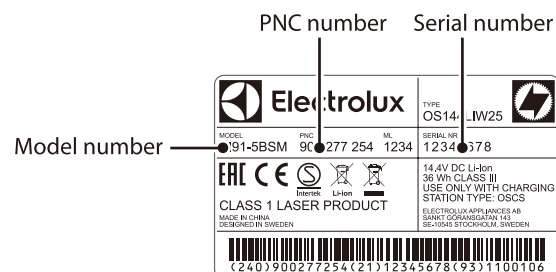

## 安全注意事项

对于8岁及以上的儿童和存在身体、感觉或精神障碍以及缺乏相关经验和知识的人士，在得到有关安全使用的监督或指导并能理解相关危害的情况下，才可以使用设备。

智能机器人吸尘器只能用于家庭/室内环境中的正常吸尘用途。

确保智能机器人吸尘器存放在干燥位置。

所有维护或修理必须由授权的 Electrolux 服务中心提供。

在清洁或维护智能机器人吸尘器之前，将智能机器人吸尘器从充电器处断开。

请勿让儿童玩耍此设备。

所有包装材料（如塑料或织物袋）应置于儿童接触不到的地方，以防窒息。

该智能机器人吸尘器设计用于特定电压。检查您的电源电压是否与充电适配器铭牌上所标示的电压相符。

只能使用专为本智能机器人吸尘器设计的原装充电器和适配器。

切勿在以下情况使用智能机器人吸尘器：

- 潮湿的地方。
- 接近易燃气体等。
- 产品出现明显的损坏迹象。
- 存在尖锐物体或液体。
- 存在热或冷的灰烬、点燃的烟头等
- 存在细粉尘，例如石膏、水泥、面粉、热或冷的灰烬。
- 请勿将智能机器人吸尘器置于阳光直射的地方。
- 避免将智能机器人吸尘器暴露在强热环境中。
- 内部电池组不得拆卸、短接或放置在金属表面。仅使用为此智能机器人吸尘器设计的电池组。
- 在处理之前，务必从设备上取下电池。
- 取出电池时，切勿将设备与电源连接。
- 电池应安全处理。
- 切勿在不使用滤网的情况下使用智能机器人吸尘器。
- 在清洁器打开且辊刷转动时，切勿触摸辊刷。智能机器人吸尘器运行时切勿触摸滚轮。

如果未按照上述建议使用智能机器人吸尘器可能会导致严重人身伤害或产品损坏。此类损伤或损坏均不在保修范围内或由Electrolux承担责任。

保修不包括由于电池寿命或使用而导致的电池运行时间缩短，因为电池寿命取决于智能机器人吸尘器的使用时间长短和次数。

清洁前，从地板上清除衣物、窗帘绳、纸张和电源线等小而易碎的物体。如果设备经过电源线并拉动电源线，则存在将物体从桌子或架子上拉下的风险。

智能机器人吸尘器设计不会移动途中任何较大物体。因此，椅子等可以留在地板上，因为智能机器人吸尘器将在避开而在它们周围清洁。

强光、镜面墙、落地窗和非常炫目的物体可能会干扰3D视觉系统。

请访问我们的网站：



获取使用建议、产品说明，或和伊莱克斯客户服务中心联系取得服务信息或获取耗材和配件购买信息：[www.electrolux.com.cn](http://www.electrolux.com.cn)



客服电话：**95105801**



服务邮箱：[saservice.china@electrolux.com](mailto:saservice.china@electrolux.com)

## Electrolux电池产品的推荐操作、充电和储存环境

### 1.操作、充电和储存条件

本产品适用于正常家庭环境，不应置于异常温度中。

为了保护产品的内部零件，不应在以下场所存放、充电或操作：

- 环境温度低于10° C或超过30° C。
- 如果产品的储存温度低于10° C或超过30° C。请等待几个小时，在产品的内部组件冷却或升温及干燥后方可使用。在室外温度范围使用和存储设备可能会损害产品或降低使用寿命。
- 湿度低于20%或超过80%（非冷凝）

以下情况产品充电至少24小时：

- 首次使用前。
- 在长时间存放之前。（长时间存放之前请取出智能机器人吸尘器的电池。）
- 长时间存放之后。

### 2.露水冷凝警告

在以下条件下可能在产品内部形成露水冷凝：

- 本机从寒冷处移动到温暖处。
- 在极高湿度条件下。
- 加热寒冷的房间后。

请等待几个小时，以便产品的内部组件在使用前升温 and 干燥。

### 3.为维持电池寿命和性能：

- 始终保持机器人在不使用时充电。
- 在清洁周期后尽快充电。等待太久可能会影响电池。

## 环境问题



产品上的此符号表示本产品包含内置的可充电电池，不得与普通生活垃圾一起处理。



产品或包装上的此符号表示该产品不能作为家庭废弃物来弃置。

要回收您的产品，请将其送至官方收集点或Electrolux服务中心，以便以安全和专业的方式清除和回收电池和电气部件。按照您所在国家的规定，单独收集电气产品和可充电电池。

## 客户服务

联系Electrolux服务中心时，请务必提供以下数据：

- 型号
- PNC编号
- 序列号

可以在铭牌上找到相关信息。

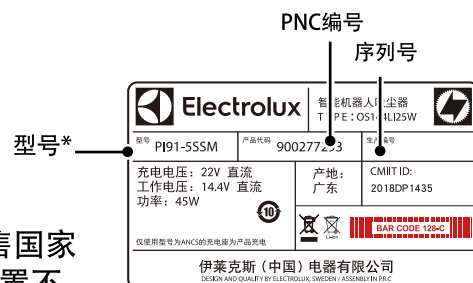

\*型号会根据销售国家级产品颜色或配置不同而不同



\* 如有必要，授权服务中心将要求您提供购买发票或其他购买凭据作为维修依据。

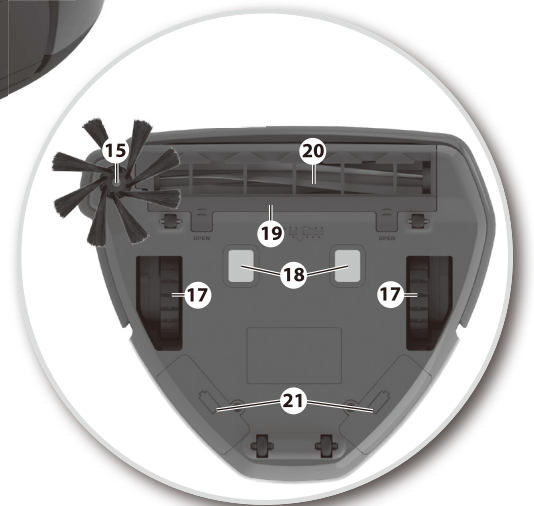
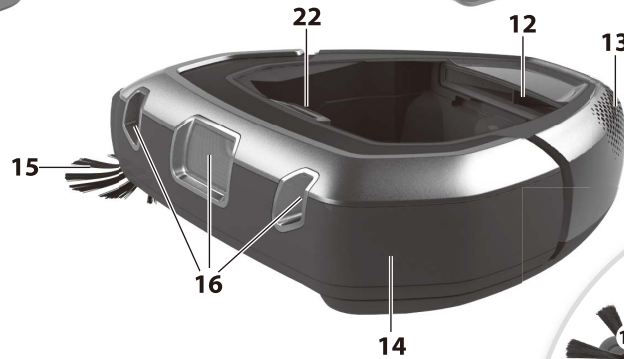
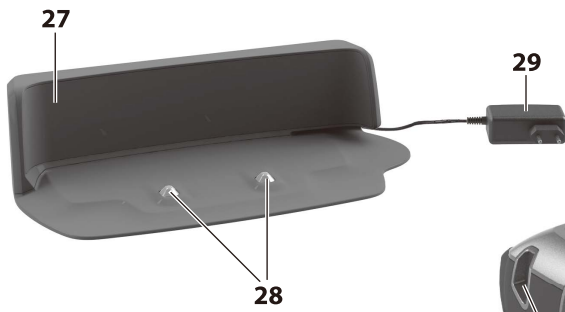
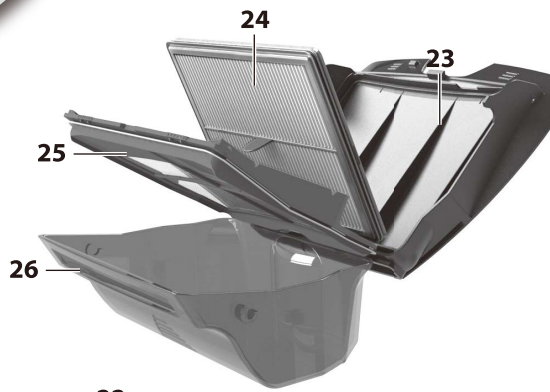

## English

**Before starting**

- Unpack your Electrolux PUREi9 robot vacuum cleaner and check that all accessories are included.\*
- Read the instruction manual carefully.
- Pay special attention to the Safety advice chapter.

*We recommend that you download the "PUREi9" App, and update the software before the first use.*

*Enjoy your Electrolux PUREi9 robot vacuum cleaner!*

**Table of contents:**

|  |    |
|--|----|
| Safety precautions                             | 2  |
| Consumer information and sustainability policy | 2  |
| How to use the robot                           | 8  |
| How to connect to the "PUREi9" APP             | 9  |
| Tips on how to get the best results            | 11 |
| Emptying the Dust container                    | 13 |
| Cleaning/Replacing the Filter                  | 13 |
| Cleaning and maintenance                       | 14 |
| Changing the batteries                         | 15 |
| Error handling                                 | 15 |
| Troubleshooting                                | 16 |

**Description of your robot vacuum cleaner**

- 1 Display / Control panel
- 2 ECO function button
- 3 SPOT cleaning button
- 4 Play/Pause button / Off button (long press)
- 5 Home button
- 6 Clock
- 7 Dust container indicator
- 8 WIFI connection indicator
- 9 Scheduled cleaning indicator
- 10 Warning indicator
- 11 Battery status indicator
- 12 Fan unit
- 13 Air outlet
- 14 Bumper
- 15 Side brush
- 16 3D Vision System (Camera)
- 17 Main wheels
- 18 Charging connectors
- 19 Brush roll lid
- 20 Brush roll
- 21 Battery compartments
- 22 Dust container release button
- 23 Dust container lid
- 24 Filter
- 25 Filter frame (and mesh net)
- 26 Dust container
- 27 Charging base
- 28 Charging connectors
- 29 Power adaptor and cord

\* Accessories may vary from model to model.

## 简体中文版

## 使用前指南

- 打开Electrolux PUREi9智能机器人吸尘器包装，并检查是否包括所有附件。
- 请仔细阅读本说明手册。
- 应特别注意安全建议章节。

我们建议您下载“PUREi9”应用，并在首次使用之前更新软件。

享受Electrolux PUREi9智能机器人吸尘器的服务！

## 目录：

|                 |    |
|-----------------|----|
| 安全预防措施          | 4  |
| 消费信息和可持续政策      | 4  |
| 如何使用智能机器人吸尘器    | 8  |
| 如何连接到“PUREi9”应用 | 9  |
| 如何发挥理想效果的提示     | 11 |
| 清空集尘盒           | 13 |
| 清洁/更换滤网         | 13 |
| 清洁和维护           | 14 |
| 更换电池            | 15 |
| 错误处理            | 15 |
| 疑难解答            | 17 |

## 智能机器人吸尘器的说明

- 1 显示/控制面板
- 2 节能模式功能按钮
- 3 SPOT定点清洁按钮
- 4 运行/暂停按钮/关闭按钮（长按）
- 5 返回充电座按钮
- 6 时钟
- 7 集尘盒指示灯
- 8 WIFI连接指示灯
- 9 预约清洁指示灯
- 10 警告指示灯
- 11 电池状态指示灯
- 12 风扇装置
- 13 出风口
- 14 防撞缓冲器
- 15 侧边毛刷
- 16 3D视觉系统（摄像机）
- 17 主滚轮
- 18 充电触点
- 19 辊刷盖
- 20 辊刷
- 21 电池仓
- 22 集尘盒释放按钮
- 23 集尘盒盖
- 24 滤网
- 25 滤网框架（和网格网）
- 26 集尘盒
- 27 充电底座
- 28 充电触点
- 29 电源适配器和电源线

\* 配件可能因型号而异。

## Installation of the robot vacuum cleaner

## 安装智能机器人吸尘器

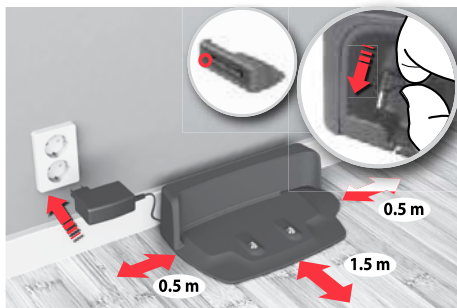

- 1. Place the Charging base** on the floor against the wall. Plug the adaptor to the power jack on the side of the base. Connect the Power cord plug to the main socket. Wind up excessive cord on the back of the base. Make sure there is an empty area of 0.5 m on the sides and 1.5 m in front of the Charging base.

**WiFi model:** Place the base in range of the WiFi router.

1. 将充电底座放在地板上，靠在墙边。将适配器插入底座侧面的电源插孔。将电源线插头连接到主插座。收起底座背面过长的电源线。确保充电底座两侧有0.5 m的空间，前面有1.5 m的空间。  
WiFi型号：将底座放在WiFi路由器的范围内。



- 2. Place the side brush.**

**Note:** If the robot is used to clean rooms with wall-to-wall carpet, remove the side brush for best cleaning results.

2. 装上侧边毛刷。  
注意：如果智能机器人吸尘器用于清洁完全覆盖地毯的房间，请取下侧边毛刷，以获得理想清洁效果。



- 3. Place the robot on the Charging base.**

The Battery icon will pulse, to indicate that the robot is recharging.

3. 将智能机器人吸尘器放在充电底座上。电池图标将闪烁，表示智能机器人吸尘器正在充电。

## Battery/Charging status

## 电池/充电状态

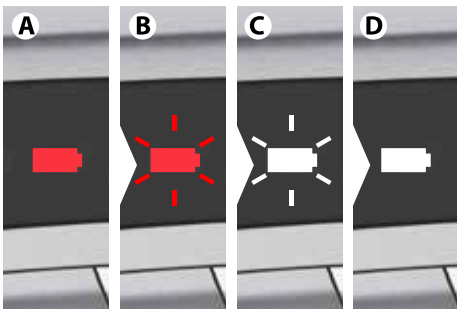

- 1. Red battery (A)** indicates that the robot needs to get charged.  
**Red light pulse (B):** The robot is charging – Low charging level.  
**White light pulse (C):** The robot has charged enough to be used. (Press Play/Pause button to clean.)  
**White light (D):** The robot is ready for use.  
Full charging time is ~3 hours.

1. 红色电池 (A) 图标表示智能机器人吸尘器需要充电。  
红灯闪烁 (B)：智能机器人吸尘器正在充电 - 电量较低。  
白灯闪烁 (C)：智能机器人吸尘器所充电量已足够使用。（按运行/暂停按钮进行清理。）  
白灯 (D)：智能机器人吸尘器准备就绪。  
充满电约需3小时。



- 2. To preserve the battery life and performance:**

- Always keep the robot charging when not in use.
- Charge it as soon as possible in the charging base after the cleaning cycle. Waiting too long might affect the batteries.

2. 为维持电池寿命和性能：  
- 始终保持智能机器人吸尘器在不使用时充电。  
- 在清洁周期后，在充电底座中尽快充电。等待太久可能会影响电池。

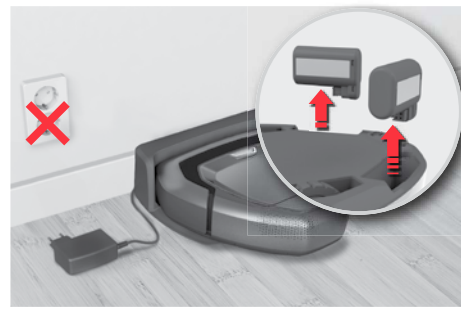

- 3. Storage (not plugged):** In case the robot is stored without being charged for a longer period of time, remove the batteries and store them separately. (Charge batteries before removing them).

To remove the batteries see instruction page 15.

3. 存放（未插入插座）：如果智能机器人吸尘器需在较长时间不充电的情况下存放，请取出电池并单独存放。（在取出电池之前对其充电）。如何取出电池，请参见第15页说明。

## How to connect to the "PUREi9" APP 如何连接到 "PUREi9" 应用



1. Download the "PUREi9" App in the App Store or Google play and then follow the instruction to create the account and connect to the robot.

**Note:** Make sure that the phone is connected to the home WiFi (2.4 GHz).

1. 在AppStore或GooglePlay中下载 "PUREi9" 应用, 然后按照说明创建帐户并连接到智能机器人吸尘器。  
注意: 确保手机已连接到家庭WiFi (2.4 GHz)

We recommend to download the App and update the software before the first use.  
我们建议在首次使用之前下载应用并更新软件。



2. During the process the App will ask you to turn the robot upside down to activate the WiFi module and scan the serial number bar code (A) or enter it manually (B). Then continue following the instruction from the App.  
**Note:** before turning the robot, make sure that it has been switched on for at least one minute.

2. 在此过程中, 应用会要求您翻转智能机器人吸尘器以激活WiFi模块并扫描序列号条形码 (A) 或手动输入条形码 (B)。然后继续按照App的指示操作。  
注意: 在翻转智能机器人吸尘器之前, 确保智能机器人吸尘器已经打开至少一分钟。



3. When the setup is completed, turn the robot back to its normal position. The WiFi symbol (A) will be lit up to indicate that the robot is connected to your home network. **Note:** it could take a few moments for the robot clock to automatically synchronise with your mobile device.  
**Note:** Pulsing WiFi symbol indicates that the robot is trying to connect to the network.

3. 设置完成后, 将智能机器人吸尘器翻转回正常位置。WiFi标志 (A) 将亮起, 表示智能机器人吸尘器已连接到家庭网络。  
注意: 智能机器人吸尘器时钟可能需要一段时间才能与移动设备自动同步。  
注意: WiFi标志闪烁则表示智能机器人吸尘器正在尝试连接到网络。

## Cleaning schedule 预约清洁



Cleaning can be scheduled in the APP (Days & time)

可以在APP中制定预约清洁 (日期和时间)

## Cleaning modes 清洁模式

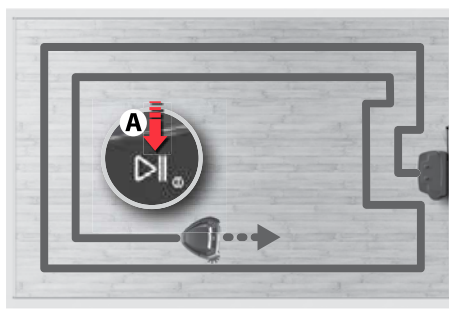

1. Press Play/Pause button (A) to start cleaning.  
After a few seconds of start-up, cleaning will be commenced. The robot will start cleaning alongside walls, working its way inwards.  
**Note:** Press "Play/Pause" (A) briefly to pause cleaning, or press and hold to terminate cleaning.

1. 按下运行/暂停按钮 (A) 开始清洁。  
启动几秒钟后, 清洁程序将开始。智能机器人吸尘器将开始沿着墙壁向内清洁。  
注意: 按下 "运行/暂停" (A) 按钮暂停清洁, 长按该按钮则会终止清洁。

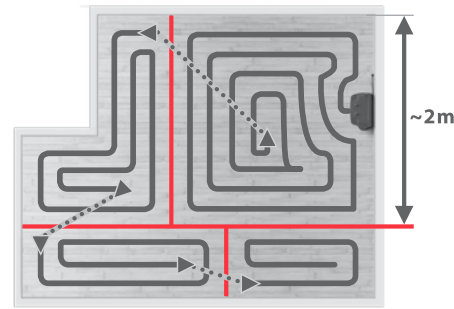

2. Large rooms will be divided into cells of at most 2 x 2 m.  
**Note:** The cleaning pattern is more efficient if the robot is started next to a wall.

2. 大房间将分为最大2 x 2米的区域。  
注意: 如果智能机器人吸尘器靠近墙壁启动, 清洁将更高效。

**Auto Docking/Charging**

自动返回充电底座/充电

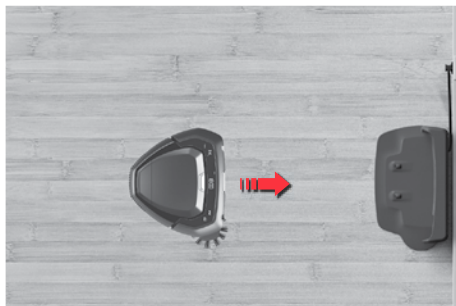

**When cleaning is completed**, the robot automatically returns to the charging base.

**Note:** If the robot is not started from the charging base, it will return to the start position when finished.

清洁完成后，智能机器人吸尘器自动返回充电底座。

注意：如果智能机器人吸尘器没有从充电底座启动，完成后将返回到开始位置。

**Auto charging during cleaning cycle**

在清洁过程中自动充电

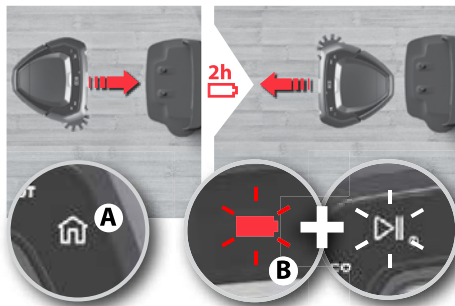

**Should recharging be needed during cleaning**, the home button will light up and the robot will return to the charging base. Home button (A) is lit. The battery and Play/Pause button (B) flash to indicate that the robot is charging and that it will resume where it stopped. The robot will recharge up to 80% to resume cleaning quicker. Charging time is ~2 hours.

如果在清洁过程中需要充电，返回充电座按钮将亮起，智能机器人吸尘器将返回充电底座。返回充电座按钮(A)亮起。电池和运行/暂停按钮(B)闪烁，表示智能机器人吸尘器正在充电，并将在其停止的位置恢复运行。智能机器人吸尘器将充电至最多80%以更快地恢复清洁工作。充电时间约2小时。

**Crossing threshold**

跨越门槛

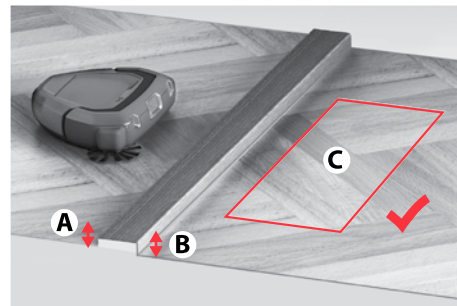

**Before crossing a threshold or climbing over any obstacle**, the robot will stop and check:

- the heights (A & B) on both sides of the threshold/obstacle
- that the area on the other side is clear to operate (C)

在跨越任何门槛之前，智能机器人吸尘器将停止并检查底座

- 门槛/障碍物两侧的高度 (A和B)
- 另一侧区域是否开阔方便运行 (C)

**ECO Mode**

节能模式



**ECO mode:** For a lighter cleaning, press the ECO button to reduce the power, prolong the running time and reduce noise level. The robot will stay in ECO mode until the button is pressed again.

节能模式：对于较轻松的清洁工作，请按ECO按钮降低功率，延长运行时间并降低噪音水平。再次按下此按钮之前，智能机器人吸尘器将保持节能模式。

**Docking**

返回底座



**Stop cleaning and send the robot to the charging base:** Press the Home button. If the robot is not started from the charging base, it will return to the starting position.

停止清洁并使智能机器人吸尘器返回充电底座：按返回充电座按钮。如果智能机器人吸尘器不是从充电底座启动，它将返回起始位置。

**SPOT Cleaning**

定点清洁

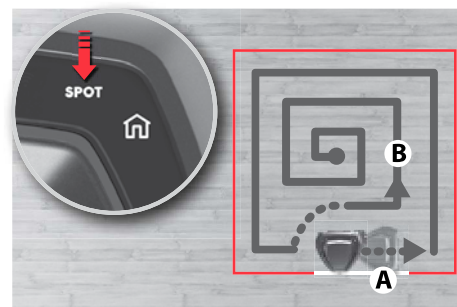

**SPOT cleaning (small area, ~1 m<sup>2</sup>):** Place the robot facing the spot and press the SPOT button. The robot will clean the area twice.

定点清洁（小面积，大约为1平方米）：将智能机器人吸尘器面向定点区域放置，然后按SPOT按钮。智能机器人吸尘器将清洁该区域两次。

## Preparing the cleaning area

### 准备清洁区域

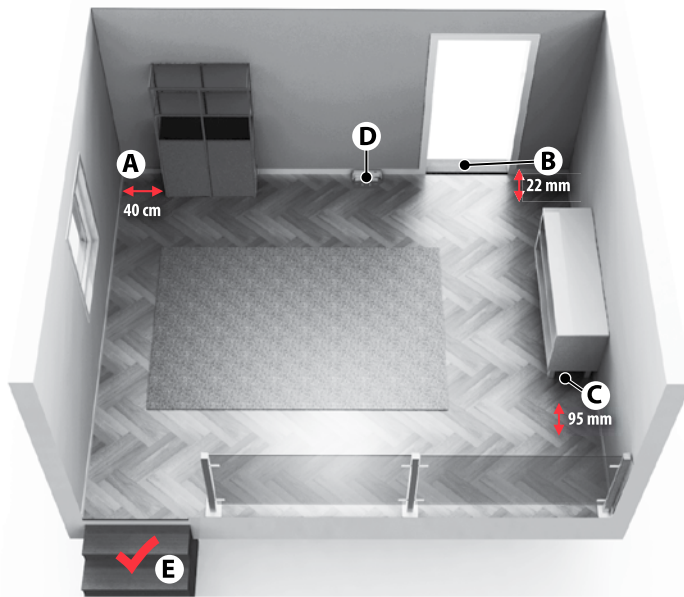

- (A) Leave a space of 40 cm around furniture without legs.
- (B) The robot easily crosses thresholds with a height up to 22 mm.
- (C) It cleans under furniture with more than 95 mm space under.
- (D) Place the charging base on the left side of a door.
- (E) The robot detects stairs and steep cliffs.

- (A) 在落地式家具周围留出40厘米的空间。
- (B) 智能机器人吸尘器能够轻松跨越高度低于22毫米的门槛。
- (C) 能够在下方空间高度超过95毫米的家具下进行清洁。
- (D) 将充电底座放在门的左侧。
- (E) 智能机器人吸尘器可以检测楼梯和边缘。

## Preparing the cleaning area

Before cleaning, remove smaller and fragile objects such as clothing, curtain strings, papers and power cords from the floor. If the device passes over a power cord and drags it, there is a risk that an object could be pulled off a table or shelf.

Larger/taller objects such as chairs can be left as the robot will clean around them.

Strong light, Mirrored walls, floor-to-ceiling windows and very shining objects could disturb the 3D Vision system.

## Limiting the cleaning area

The robot will clean all floors it can access. To limit the cleaning area, simply close doors or put an obstacle in the way.

## Dust emptying between scheduled cleanings

To get the most out of scheduled cleaning, empty the dust container regularly.

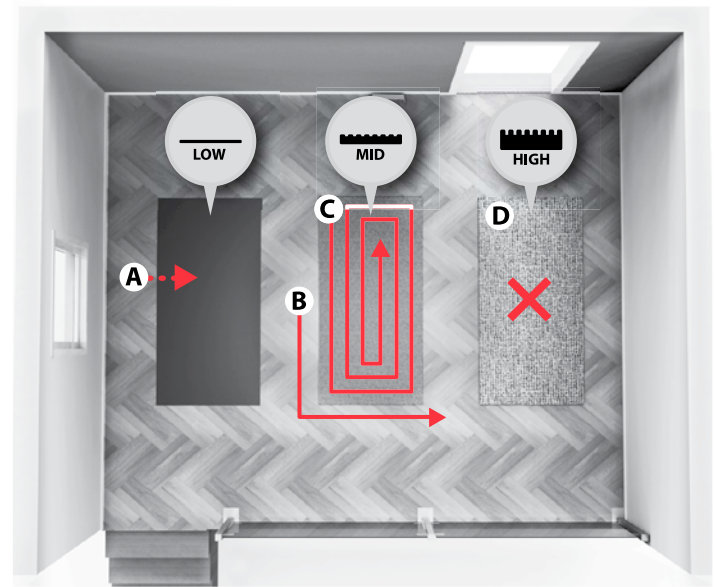

**Carpets:** The robot cleans

- **short-pile carpets:** (A) in the same pattern as the room
- **medium-pile carpets:** (B) first around it (C) and comes back later to clean the carpet separately
- **high-pile carpets:** (D) are not cleaned. When the robot reaches the edge it continues with the rest of the cleaning.

**地毯：**智能机器人吸尘器清洁

- **短绒地毯：**(A) 清洁模式与房间相同
- **中绒地毯：**(B) 首先围绕地毯进行清洁 (C)，然后返回单独对地毯进行清洁。
- **长绒地毯：**(D) 无法清洁。当智能机器人吸尘器到达边缘时，会继续进行其余区域的清洁工作。

## 准备清洁区域

在清洁之前，从地板上清除较小和易碎的物体，如衣物、窗帘绳、纸张和电源线。如果设备经过电源线并拉动电源线，则存在将物体从桌子或架子上拉下的风险。

较大/较高的物体（例如椅子）可以留下，因为智能机器人吸尘器将围绕它们进行清洁。

强光、镜面墙、落地窗和非常炫目的物体可能会干扰3D视觉系统。

## 限制清洁区域

智能机器人吸尘器将清洁它可以到达的所有地板。要限制清洁区域，只需关上门或在途中放置障碍物。

## 在定期清洗间歇清空灰尘

为了使更大程度发挥清洁效果，请定时清洁集尘盒。



**Always carry the robot with two hands keeping the front up. Manual moving of the robot:**

Moving the robot during the cleaning process is not advised, as it might restart the cleaning from the beginning.

挪动智能机器人吸尘器时请务必使用双手，保持智能机器人吸尘器正面朝上。手动移动智能机器人吸尘器：  
不建议在清洁过程中移动智能机器人吸尘器，因为可能会使它重新开始清洁。

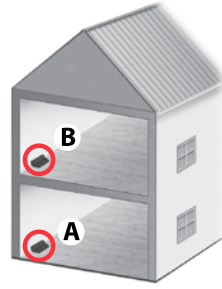

**Cleaning of a house with more than one floor can be facilitated by using an extra charging base on each floor. (ANC: 406000071)**

如果房子有多个楼层，在每层使用单独的充电底座，可以方便清洁工作。(ANC:406000071)

Turn the robot off / 关闭智能机器人吸尘器

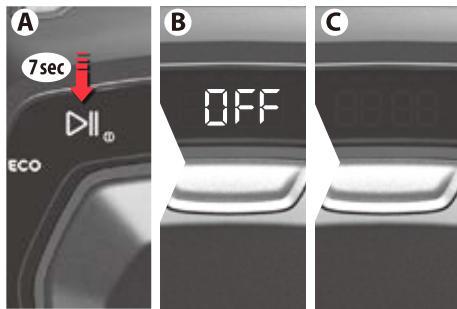

**Turn the robot off:** There is also the possibility to turn the robot completely off, in case you are not using it for a certain amount of time. To do this, please follow the steps:

- Press the play button (A) on the robot for approx. 7 seconds.
- "OFF" is shown on the display (B).
- When the display turns dark, the robot is fully off (C).

关闭智能机器人吸尘器:如果您长时间不使用智能机器人吸尘器,也可以将智能机器人吸尘器完全关闭。请按照以下步骤操作:  
- 长按运行/暂停按键(A)大约7秒。  
- 显示屏上显示“OFF”(B)。  
- 当显示屏完全变暗时(C),智能机器人吸尘器已经被完全关闭。

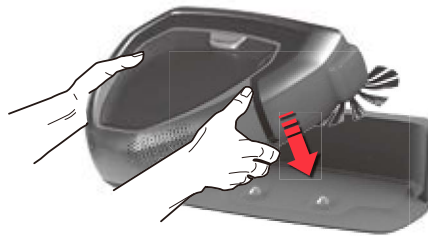

**To restart the robot and use it again, insert it into the charging base.** It is also possible to turn it off in the charging base, then you need to lift it and put it in the charging base again to use it.

如果需要重新启动智能机器人吸尘器,请把智能机器人吸尘器放入连接在电源的充电底座上。当您的智能机器人吸尘器已经完全关闭,并已经放置在充电底座上时,可以将它拿起,并重新再次放入充电底座,这样智能机器人吸尘器会被重新启动。

## Emptying the Dust container

## 清空集尘盒



1. Empty the dust container regularly or when the dust container icon lights up.

⚠ If the dust bin symbol remains lit up when the dust bin is empty, please clean the filter.

1. 定期清空集尘盒, 或当集尘盒图标亮起时清空集尘盒。

⚠ 如果集尘盒是空的, 但是集尘盒图标保持亮起状态, 请清洁滤网。

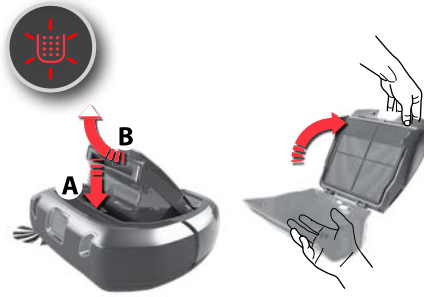

2. Press Release button (A), remove the Dust container by swinging it upwards (B).

Open the lid by swinging it upwards.

Empty the dust container into a waste bin.

**Note:** The dust container icon flashes to indicate that the Dust container has been removed, or is not in the right position.

2. 按下释放按钮 (A), 通过向上提拉卸下集尘盒 (B)。

向上转动打开盖子。

将集尘盒中灰尘倒入垃圾箱。

注意: 集尘盒图标闪烁, 表示集尘盒已被取出或放置不当。



3. After emptying the container, close the lid and put it back in place

Refit the Dust container in the robot.

**Note:** If the Dust container has not been properly assembled and Play/Pause button is pressed, the dust container icon flashes. Refit the Dust container properly.

3. 清空集尘盒后, 关闭盖子并将其放回原处 将集尘盒重新安装在智能机器人吸尘器中。

注意: 如果在集尘盒未正确安装的情况下按下运行/暂停按钮, 集尘盒图标会闪烁。请重新正确安装集尘盒。

## Cleaning the Filter

## 清洁滤网



1. For best performance, we recommend to clean the filter every 5th cleaning and to replace it every 6 months. (Ref: ERK2)

1. 为了发挥理想性能, 我们建议每进行5次清扫, 即对滤网进行一次清洁。建议每6个月更换滤网一次。  
(参照: ERK2)

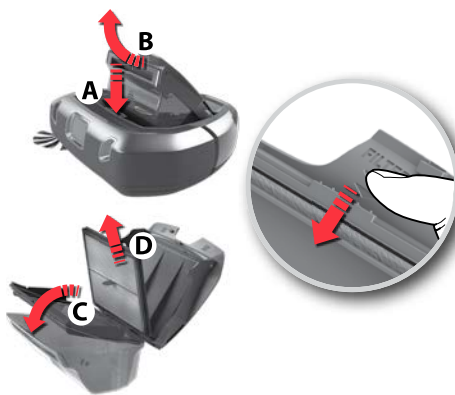

2. Remove the filter:

Remove the Dust container by swinging it upwards (B).

Open the lid by swinging it upwards.

Swing the Filter frame downwards (C).

Remove the filter (D).

2. 移除滤网:

向上提拉卸下集尘盒 (B)。

向上转动打开盖子。

向下旋转滤网框架 (C)。

取下滤网 (D)。

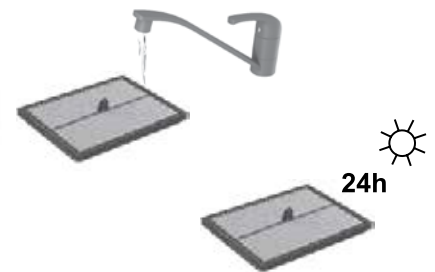

3. Rinse the filter with cold water. Tap the filter frame to remove water. Let dry for 24 hours before placing it back in the machine.

3. 用冷水冲洗滤网。轻敲滤网框架以除去水分。干燥24小时后再放回机器。

**Cleaning the 3D Vision System (Camera)**

清洁3D视觉系统（摄像机）



**The 3D Vision System works best if the windows (A,B,C) are kept clean and free from scratches.**

Clean off light dust by using a dry soft cloth. If its heavily soiled you can use a mild detergent to clean it.

请保持窗口（A、B、C）清洁且没有划痕，这样3D视觉系统可以发挥理想性能。使用干燥的软布清洁微小灰尘。如果污渍严重，可以使用温和的清洁剂进行清洁。

**Cleaning the Wheels**

清洁滚轮



**1. Remove entangled hairs or such from the main wheels so that they can turn freely.**

1. 去除主轮上缠绕的毛发等，使其可以自由转动。

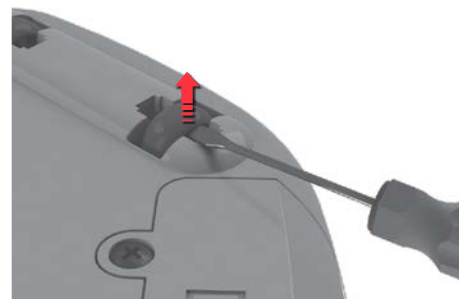

**2. Should the small wheels get stuck, remove them carefully by using a small screwdriver and clean the wheels.**

2. 如果小轮卡住，请使用小螺丝刀小心地将其拆下进行清洁。

**Cleaning the Side brush**

清洁侧边毛刷

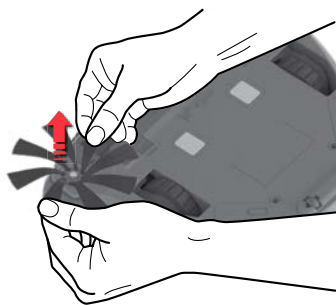

**Pull the Side brush to remove it.** Clean the Side brush. Reattach the Side brush in the socket. Side brush can be changed. (Ref: ERK2 / EBSB2)

拉动侧边毛刷将其取出。清洁侧边毛刷。将侧边毛刷重新安装在插座中。侧边毛刷可以更换。（参照：ERK2 / EBSB2）

**Cleaning the Brush roll**

清洁辊刷



**1. Press the two latches and slide the lid forward to remove the brush roll lid.**

1. 按下两个卡销，向前滑动盖子，即可取下辊刷盖。



**2. Pull out the Brush roll and clean the brush and bearings.** Remove entangled threads by snipping them away with scissors. Refit in reverse order. Brush roll can be replaced. (Ref: ERK2)

2. 拉出辊刷并清洁刷子和轴承。用剪刀剪去缠绕的丝线。以相反的顺序重新装回。辊刷可更换。（参照：ERK2）

## Cleaning the Air channel

清洁空气通道



**Remove the dust container.** Remove clogged debris in the air channel. Put the dust container back into place.

取出集尘盒。清除空气通道中堵塞的碎屑。将集尘盒安装到位。

## Changing the batteries

更换电池

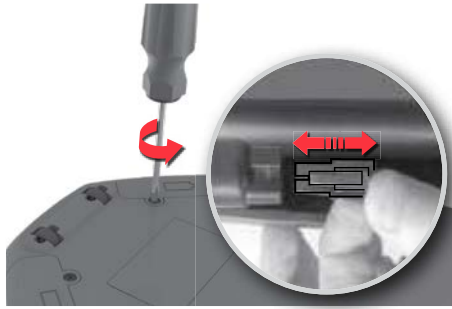

**1. The battery compartments are located on the bottom side of the robot.** Use a screwdriver (PH2) to unscrew the battery compartment lids. Replace the battery packs and refit the battery compartment lids.

**⚠ Caution!** Make sure to change the two battery packs at the same time.

1. 电池仓位于机器人吸尘器的底部。使用螺丝刀 (PH2) 拧下电池仓盖。更换电池组, 然后重新安装电池仓盖。

**⚠ 警告!** 请务必同时更换两个电池组。

**2. Use only original supplier batteries.**

Batteries must be removed and disposed of safely, before desposing of the machine. (ANC: 405 537 959/0)

2. 只能使用原装电池。在处理机器之前, 必须将电池拆除并安全处理。(ANC:405 537 959/0)

## Cleaning the charging connectors

清洁充电触点



**Use a dry soft cloth to clean regularly the charging connectors** on the charging base and under the machine.

请经常使用干燥柔软的布擦拭充电座以及机身背后的充电触点 (如红圈所示位置)

## Error handling

错误处理



**1. If an error occurs,** the robot stops cleaning. The warning icon will pulse and the digits **"E:"** followed by an **error code**, is shown on the display. The speaker will also describe the error. After an error has occurred, press any button to play the audio message again.

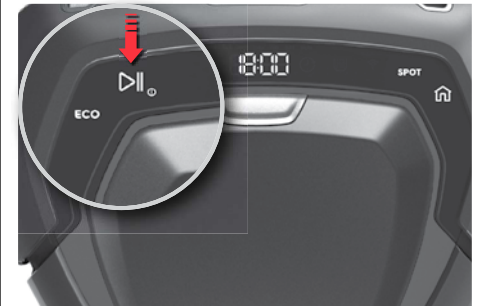

1. 如果发生错误, 智能机器人吸尘器将停止清洁。警告图标将闪烁, 显示屏上显示数字 "E:" 加错误代码。扬声器同样会提示这一错误信息。出现错误后, 按任意按钮可重放音频消息。



**2. When an error is resolved,** press Play/Pause button to start cleaning.  
**Note:** For a complete list of the error codes and solutions, see instructions in "Troubleshooting".

2. 当错误被解决后, 按运行/暂停按钮开始清洁。  
注意: 有关错误代码和解决方案的完整列表, 请参阅 "故障排除" 中的说明。

## Troubleshooting

| Problem                                 | Error Code   | Cause  | Solution  |
|---|--|--|---|
| The display is blank.                   | -  | The battery is empty.  | Charge the battery.   |
| The robot does not start.               | <br><br><br>(x3) | The Dust container is not present or properly closed.                                | Place the Dust container in the robot, properly close the lid.  |
|   |  | The robot is lifted.   | Place the robot on the floor before starting.   |
| The robot does not move/clean properly. | E:10   | The bumper is stuck  | Please make sure the bumper can move properly and remove any debris that might block it.  |
|   | E:11   | Right wheel is stuck   | Check that all parts turn freely.   |
|   | E:12   | Left wheel is stuck  | Clean and remove entangled threads from parts if needed.  |
|   | E:13   | Brush roll is stuck  | Replace Brush roll or Side brush if damaged.  |
|   | E:14   | Side brush is stuck  | Check "Cleaning and maintenance" page 14.   |
|   | E:15   | The robot is stuck or unable to navigate.  | Lift and place the robot where it can move freely. Check "Tips on how to get the best results" page 11.   |
|   | E:16   | The 3D Vision System is blocked or dusty.  | Clean the 3D Vision System and make sure nothing is blocking the sight. Check "Cleaning and maintenance" page 14.   |
| No charge indication                    | -  | The power cord and adapter is not properly assembled, and/or connected to the mains. | Connect the adapter connector to the Charging base. Connect the power cable to the mains. Make sure the Charging plates on the robot and the Charging base are connected. |
|   |  | The Charging plates on the robot and the Charging base are not connected.            | Check that the plug and cable are not damaged.  |
| The batteries runs empty fast           | -  | The batteries life has expired.  | Change the 2 battery packs. Check "Changing the batteries" page 15.   |
| Battery related problems                | E:20   | Incorrect Charging base is used.   | Only use the original Electrolux Charging base, supplied with the robot. If the Charging base needs to be replaced; use Electrolux Charging base (ANC: 406000071).        |
|   | E:21   | Batteries are malfunctioning during use.   | Change the 2 battery packs. Check "Changing the batteries" page 15.   |
|   | E:22   | Product temperature is too high.   | Let the robot paused outside the charging station for 6 hours.  |
|   | E:23   | Batteries are not properly connected to the robot.                                   | Connect batteries to robot. Check "Changing the batteries" page 15.   |
| The time is not displayed.              | --:--  | The current time is not set.   | When the robot is connected to WiFi the time will automatically set.  |

| Problem   | Error Code | Cause  | Solution   |
|---|------------|--|--|
| Wrong time is displayed on the robot.   | -          | The robot has not received updated time from the WiFi network.       | Make sure the robot is connected to the WiFi network and wait until it receives the correct time. If it does not update within 24 hours redo the onboarding procedure.       |
| The room is not properly cleaned, but the robot returns to the Charging base. | -          | The robot is returning to the Charging base to charge the batteries. | The robot will automatically continue the cleaning program as soon as the batteries are recharged.   |
| Water has been sucked into the robot.   | -          | -  | It will be necessary to replace the motor at an authorized Electrolux service centre. Damage to the motor caused by the penetration of water is not covered by the warranty. |
| Software issue  | E:30       | Software is not working correctly.                                   | Please update the robot's software.  |
|   | E:31       | Software upgrade has failed.   | Please redo software update.   |
| Service needed  | E:40       | -  | Contact an authorized Electrolux service center.   |
| System error  | E:41       | Internal error.  | Please restart desired operation.  |
|   | E:42       | -  |  |

**For any further problems, please check the service area in the APP or on our website.**

## Consumables &amp; Accessories

 [www.electrolux.com/shop](http://www.electrolux.com/shop)

 PUREi9 Performance kit  
Ref: ERK2  
PNC: 9001677674



 PUREi9 Power brush  
REF: EBSB2  
PNC: 9001683938



 Charging base  
ANC: 406000071



 Battery pack  
ANC: 405 537 959/0



## 故障排除

| 问题                          | 错误代码  | 原因  | 解决方法   |
|-----------------------------|---|---|--|
| 显示为空白。                      | -   | 电池电量耗尽。   | 请给电池充电。  |
| 智能机器人吸尘器不启动。                |  | 未安装集尘盒或未正确关闭。   | 将集尘盒放在智能机器人吸尘器中，正确关闭盒盖。  |
|                             |   | 智能机器人吸尘器被抬起。  | 将智能机器人吸尘器放置在地板上然后再启动。  |
| 智能机器人吸尘器不能正确移动/清洁。          | (x3)  | E:10 缓冲器被卡  | 请确保缓冲器能够正常移动，并清除任何可能引起堵塞的碎片。   |
|                             |   | E:11 右滚轮被卡住   | 检查所有零件是否可以正常转动。如有需要，请清洁并移除缠绕在零件上的丝线等物。                                       |
|                             |   | E:12 左滚轮被卡住   | 如有损坏，请更换滚刷或侧边毛刷。查看第14页上的“清洁和维护”  |
|                             |   | E:13 滚刷被卡住  |  |
|                             |   | E:14 侧边毛刷被卡住  |  |
|                             |   | E:15 智能机器人吸尘器被卡住或无法导航。  | 将智能机器人吸尘器提起并放置在能够自由移动的空间。查看第11页“如何发挥理想效果的提示”。                                |
|                             |   | E:16 3D视觉系统被遮挡或进灰。  | 清洁3D视觉系统并确保其视线不受遮挡。查看第14页上的“清洁和维护”。  |
|                             |   | E:17  集尘盒已满或被堵塞。 | 清空和/或清洁集尘盒。查看第13页“清空集尘盒”。  |
| 无充电指示                       | -   | 智能机器人吸尘器在过于光滑的表面运行。   | 将智能机器人吸尘器和充电器移到新的位置，再重新启动。   |
|                             |   | 电源线适配器未正确组装及/或连接到电源。  | 将电源适配器连接器与充电底座相连接。将电源线连接至电源。确保智能机器人吸尘器充电板已连接至充电底座。                           |
| 电池快速耗尽                      | -   | 智能机器人吸尘器上的充电板和充电底座未连接。  | 请检查插头与电源线是否受损。   |
| 电池相关故障                      | -   | 电池超出使用寿命。   | 更换2个电池组。查看第15页“更换电池”章节。  |
|                             |   | E:20 使用了不正确的充电底座。   | 仅使用随智能机器人吸尘器附带的原装Electrolux充电底座。如果需要更换充电底座，请使用Electrolux充电底座(ANC:406000071)。 |
|                             |   | E:21 电池在使用过程中出现故障。  | 更换2个电池组。查看第15页“更换电池”章节。  |
|                             |   | E:22 产品温度过高。  | 让智能机器人吸尘器在非充电状态下暂停6小时。   |
|                             | E:23  | 电池未能与智能机器人吸尘器正常连接。  | 为智能机器人吸尘器装上电池。查看第15页“更换电池”。  |
| 不显示时间。                      | --:--   | 未设置当前时间。  | 当智能机器人吸尘器连接到WiFi时，会自动设置时间。   |
| 智能机器人吸尘器显示错误时间。             | -   | 智能机器人吸尘器尚未从WiFi网络接收更新时间。  | 确保智能机器人吸尘器连接至WiFi网络，并等待直至接收到正确的时间。如果在24小时内没有更新，请重新执行启动过程。                    |
| 房间没有正常清洁完毕，但智能机器人吸尘器返回充电底座。 | -   | 智能机器人吸尘器正返回充电底座以进行充电。   | 一旦电池充满电，智能机器人吸尘器会自动继续清洁程序。   |
| 智能机器人吸尘器内部进水。               | -   | -   | 请务必在授权的Electrolux服务中心更换电机。由进水引起的电机损坏不在保修范围之列。                                |

| 问题                            | 错误代码 | 原因        | 解决方法                 |
|-------------------------------|------|-----------|----------------------|
| 软件问题                          | E:30 | 软件无法正常工作。 | 请更新智能机器人吸尘器的软件。      |
|                               | E:31 | 软件升级失败。   | 请重新进行软件更新。           |
| 需要服务                          | E:40 | -         | 请联系Electrolux授权服务中心。 |
| 系统错误                          | E:41 | 内部错误。     | 请重启所需操作。             |
|                               | E:42 |           |                      |
| 如有任何其他问题，请在APP或我们的网站上查看服务区信息。 |      |           |                      |

## 耗材和配件

 客服电话：9510-5801  
服务邮箱：saservice.china@electrolux.com

 PUREi9性能套件  
Ref: ERK2  
PNC: 9001677674

 PUREi9电刷  
REF: EBSB2  
PNC: 9001683938



 充电底座  
ANC: 406000071



 电池组  
ANC: 405 537 959/0



## 安全注意事項

本機設計不適合 8 歲以下兒童、體格、感官或精神能力不健全，或者是缺少經驗和知識的人士使用，除非有監護人在場或是已透過負責他們安全的人士獲得有關使用本機的說明。

本掃地機器人吸塵器(機器人吸塵器)只適用於居家/室內環境的一般清掃。

請務必將機器人吸塵器存放於乾燥的地方。

所有的服務或維修請於伊萊克斯客服中心連繫，由伊萊克斯原廠維修中心進行產品檢修。

在清潔或保養機器人吸塵器之前，請先將機器人吸塵器從充電座上取下。

請勿讓兒童自行使用本機。

包裝物料（例如塑膠袋或織物袋）皆不應放置在兒童可接觸到的地方，以免導致窒息等人身傷害。

本機器人吸塵器專為特定的電壓而設計。請檢查您的供應電壓是否與充電器／變壓器標籤上標識相同。

並使用此機器人吸塵器專屬的原裝充電座和變壓器。

切勿在下列情況使用機器人吸塵器：

- 在潮濕的地方。
- 在易燃氣體等附近。
- 產品出現明顯損壞跡象時。
- 在尖銳的物品或液體上。
- 在熱或冷的灰燼、點燃的菸頭等。
- 在石膏、混凝土、麵粉、熱或冷灰燼等微細粉塵上。
- 請勿讓機器人吸塵器受到日光直射。
- 請避免機器人吸塵器承受高熱。
- 本機內部的電池組不得再進一步進行拆卸、使其短路或放置於金屬表面。只能使用專為機器人吸塵器設計的電池組。
- 棄置本機前必須先將電池組取出。
- 取出電池組時，本機不能插上電源。
- 電池組應以安全的方式棄置。
- 切勿在無濾網情況下使用機器人吸塵器。
- 機器人吸塵器已啟動且滾刷正在轉動，請勿觸碰滾刷。當機器人吸塵器正在運作時，請勿觸碰滾輪。

若使用機器人吸塵器的方式違反上述建議，可能會造成嚴重的人身傷害或產品損壞。伊萊克斯對此等傷害或損壞不予負責，也不在產品保固範圍內。

由於電池壽命和使用方式而導致電池運作時間縮短的情形不屬於保固範圍，因為電池的使用壽命取決於使用機器人吸塵器的時間長度和次數。

進行清掃前，請先從地板上清除小型和脆弱的物體，例如衣服、窗簾繩、紙張和電源線。如果本裝置行經並拉動電源線，可能會造成物體從桌面或櫃架上掉落的風險。

機器人吸塵器經過設計，不會移動行進路徑中任何較大型的物體。因此，例如椅子等物件可留置於地板上不動，機器人吸塵器將繞行這些物件進行清掃。

強烈的光線、鏡面牆、落地窗和極為閃亮的物體可能會干擾機器的3D Vision路徑掃描規畫系統。

根據NCC低功率電波輻射性電機管理辦法 規定：

第十二條 經型式認證合格之低功率射頻電機，非經許可，公司、商號或使用者均不得擅自變更頻率、加大功率或變更原設計之特性及功能。

第十四條 低功率射頻電機之使用不得影響飛航安全及干擾合法通信；經發現有干擾現象時，應立即停用，並改善至無干擾時方得繼續使用。前項合法通信，指依電信法規定作業之無線電通信。低功率射頻電機須忍受合法通信或工業、科學及醫療用電波輻射性電機設備之干擾。

請造訪伊萊克斯網站，



取得產品使用建議、手冊、疑難排以及服務資訊：[www.electrolux.com.tw](http://www.electrolux.com.tw)



註冊產品享受更佳服務：

[electrolux.com.tw/Support/Warranty-Registration/](http://electrolux.com.tw/Support/Warranty-Registration/)



購買產品零配件及耗材、客服專線：  
**0800-888-259**

針對伊萊克斯電池產品所建議的運作、充電和存放環境

### 1. 運作、充電與存放的條件

本產品適用於正常的居家環境，不應暴露於異常溫度下。

為保護其內部的零件，本產品不應在下列環境中存放、充電或運作：

- 低於 10 ° C 或高於 30 ° C 的室溫。
- 如果將產品存放於溫度低於 10 ° C 或高於 30 ° C 的環境中。使用前請先稍候幾小時，讓內部的組件先冷卻或回暖乾燥。在合適的溫度範圍外使用和存放產品，可能會導致機器損壞或使用壽命縮短。
- 20% 以下或 80% 以上的相對濕度（未凝結）

在以下情況時，請將產品充電至少 24 小時：

- 在首次使用之前。
- 在長時間收儲之前。（在長時間收儲之前，請先充飽電後，將電池從機器人吸塵器上取出。）
- 在長時間收儲之後。

### 2. 結露警告

在下列的情況中，產品內部可能會產生凝露：



- 將裝置從低溫處移動到較高溫處。
- 在濕度極高的環境中。
- 在低溫房間啟動暖氣之後。

使用前請先稍候幾小時，讓內部的組件先回暖乾燥。

### 3. 若要維持電池的使用壽命和效能

- 未使用時請讓機器人吸塵器隨時保持充電狀態。
- 在完成清掃後盡快將機器人吸塵器充電。如果過太久才充電，可能會對電池造成影響。

### 環保考量

-  產品上的符號表示產品包含內建的可充電電池，而電池不應隨一般家庭垃圾棄置。
-  產品或其包裝上的符號表示不能將產品視為家庭垃圾進行處理。

若要回收產品，請將其送到專業回收站，以安全、專業的方式來移除和回收電池與電器零件。請遵循您所在國家的規範，分別回收電器產品和可充電電池。

### 客戶保養及檢修服務

聯絡伊萊克斯客服中心時，請備妥下列資料：

- 型號
- PNC 編號
- 製造號碼

上述資訊標示在機身的標籤上。

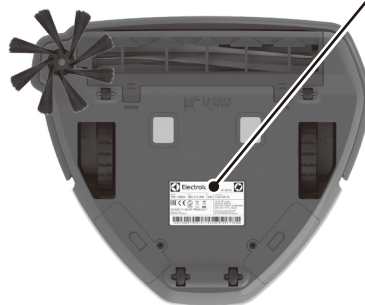
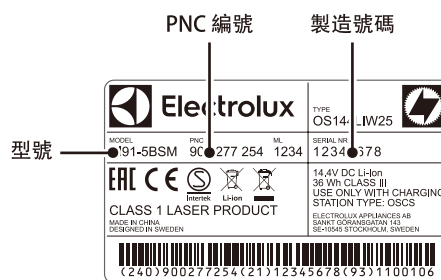

※產品型號PI91-5SSM/PI91-5SGM  
依各國實際販售情形為主。

### Tindakan pencegahan keamanan

Alat ini dapat digunakan oleh anak-anak berusia setidaknya 8 tahun dan ke atas serta orang dengan kemampuan mental, sensorik, dan fisik yang kurang atau memiliki sedikit pengalaman dan pengetahuan jika mereka diberikan pengawasan dan pengarahan tentang cara menggunakan alat ini secara aman dan mengetahui bahaya-bahaya yang ada.

Robot ini hanya dapat digunakan untuk mengisap debu di lingkungan rumah/dalam ruangan yang normal.

Pastikan robot disimpan di tempat yang kering.

*Semua layanan atau perbaikan harus dilakukan oleh pusat servis resmi Electrolux.*

Lepaskan robot dari pengisi daya sebelum melakukan pembersihan atau merawat robot.

Jangan biarkan anak-anak bermain dengan alat ini.

Bahan kemasan, misalnya tas kain atau plastik harus dijauhkan dari anak-anak untuk menghindari sesak napas.

Robot ini dirancang untuk tegangan tertentu. Periksa apakah tegangan yang masuk sama besarnya dengan yang disebutkan pada pelat keterangan yang ada di adaptor pengisian daya

Hanya gunakan stasiun pengisi daya yang asli dan adaptor yang dirancang untuk robot.

#### Jangan pernah gunakan robot:

- Di tempat yang basah.
- Dekat dengan gas yang mudah terbakar, dll.
- Jika produk menunjukkan tanda-tanda kerusakan yang terlihat.
- Di atas permukaan benda cair atau tajam.
- Di atas abu dingin atau panas, puntung rokok yang menyala, dll.
- Di atas debu halus, misalnya plester, beton, tepung, abu dingin atau panas.
- Jangan biarkan robot tergeletak di tempat yang terkena sinar matahari langsung.
- Jangan biarkan robot terpapar suhu yang tinggi.
- Dilarang membongkar kemasan baterai, menghubungkannya dengan sirkuit pendek, atau

menempatkannya pada permukaan logam. Hanya gunakan kemasan baterai yang dirancang untuk robot.

- Baterai harus dikeluarkan dari alat sebelum alat dibuang.
- Dilarang memasang alat ini saat mengeluarkan baterai.
- Baterai harus dikeluarkan secara aman.
- Jangan gunakan robot tanpa filter.
- Jangan sentuh rol sikat saat pembersih menyala dan rol sikat sedang berputar. Jangan sentuh bagian roda saat robot sedang beroperasi.

Penggunaan robot yang tidak sesuai dengan cara yang direkomendasikan di atas akan menyebabkan cedera tubuh yang serius atau kerusakan pada produk. Cedera atau kerusakan tersebut tidak dilindungi oleh garansi atau oleh Electrolux.

Garansi ini tidak mencakup pengurangan waktu proses baterai yang disebabkan oleh penggunaan atau umur baterai, karena masa pakai baterai bergantung pada lama dan frekuensi penggunaan robot.

Sebelum membersihkan, singkirkan benda yang kecil dan rapuh seperti pakaian, tali tirai, kertas, dan kabel listrik dari lantai. Jika alat melewati kabel listrik dan menyedotnya, maka kabel listrik dapat terlepas dari meja atau rak.

Robot ini tidak dirancang untuk memindahkan benda yang lebih besar dengan sendirinya. Oleh sebab itu, benda seperti kursi dapat dibiarkan di lantai karena robot akan membersihkan benda di sekelilingnya.

Cahaya yang sangat terang, cermin pada dinding, dinding kaca, dan benda yang sangat berkilau dapat mengganggu sistem Visi 3D.

#### Kunjungi situs web kami untuk:



Mendapatkan saran penggunaan, brosur, pemecahan masalah, informasi layanan:  
**[www.electrolux.com](http://www.electrolux.com)**



Daftarkan produk Anda untuk mendapatkan layanan yang lebih baik:  
**[www.electrolux.com/productregistration](http://www.electrolux.com/productregistration)**



Beli Aksesori dan Benda Habis Pakai untuk alat Anda:  
**[www.electrolux.com/shop](http://www.electrolux.com/shop)**

## Lingkungan penyimpanan, pengisian daya, dan operasi yang direkomendasikan untuk produk baterai Electrolux

### 1. Kondisi penyimpanan, pengisian daya, dan operasi

Produk ini dibuat untuk digunakan di lingkungan rumah yang normal dan tidak dapat diletakkan di ruangan yang suhunya tidak wajar.

Untuk melindungi komponen internal produk ini, Anda dilarang menyimpan, mengisi daya, atau mengoperasikan produk dalam:

- Suhu sekitar di bawah 10 °C atau di atas 30 °C.
- Jika produk disimpan di suhu di bawah 10 °C atau di atas 30 °C. Tunggu selama beberapa jam hingga komponen internal produk menjadi dingin atau panas dan kering sebelum digunakan. Interval suhu di luar penyimpanan dan penggunaan dapat merusak produk atau mengurangi masa pakainya.
- Tingkat kelembapan di bawah 20% atau di atas 80% (Non-Kondensasi)

Isi daya produk minimum selama 24 jam:

- Sebelum penggunaan pertama.
- Sebelum disimpan dalam waktu yang lama. (Keluarkan baterai dari robot sebelum disimpan dalam waktu yang lama.)
- Setelah disimpan dalam waktu yang lama.

### 2. Peringatan kondensasi embun

Kondensasi embun dapat terjadi di bagian dalam produk dalam kondisi-kondisi berikut:

- Unit dipindahkan dari tempat yang dingin ke tempat yang hangat.
- Dalam kondisi yang tingkat kelembapannya tinggi.
- Setelah memanaskan ruangan yang dingin.

Tunggu selama beberapa jam hingga komponen internal produk panas dan kering sebelum digunakan.

### 3. Untuk menjaga kinerja dan masa pakai baterai:

- Selalu simpan alat pengisi daya robot jika tidak sedang digunakan.
- Isi baterai secepatnya setelah siklus pembersihan. Menunggu terlalu lama akan memengaruhi baterai.

## Masalah lingkungan



Simbol pada produk ini menunjukkan bahwa produk ini memiliki baterai internal yang dayanya dapat diisi ulang yang tidak dapat dibuang bersama dengan sampah rumah tangga sehari-hari.



Simbol pada produk atau pada kemasan produk ini menunjukkan bahwa produk tidak dapat diperlakukan seperti sampah rumah tangga. Untuk mendaur ulang produk Anda, bawalah baterai ke tempat pengumpulan resmi atau ke pusat servis Electrolux yang dapat mengeluarkan dan mendaur ulang baterai serta komponen listrik dengan cara yang aman dan profesional. Ikuti aturan di negara Anda untuk pengumpulan terpisah baterai yang dayanya dapat diisi ulang dan produk-produk listrik.

## Layanan dan perawatan pelanggan

Saat menghubungi pusat servis Electrolux, pastikan Anda sudah memiliki data berikut

- Nomor model,
- Nomor PNC
- Nomor seri

Informasi tersebut dapat dilihat di pelat keterangan.

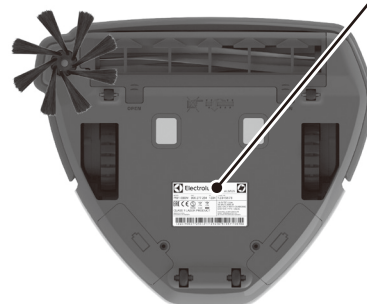
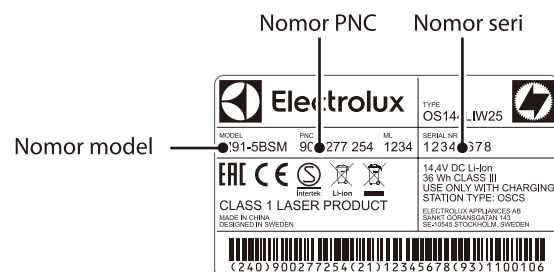

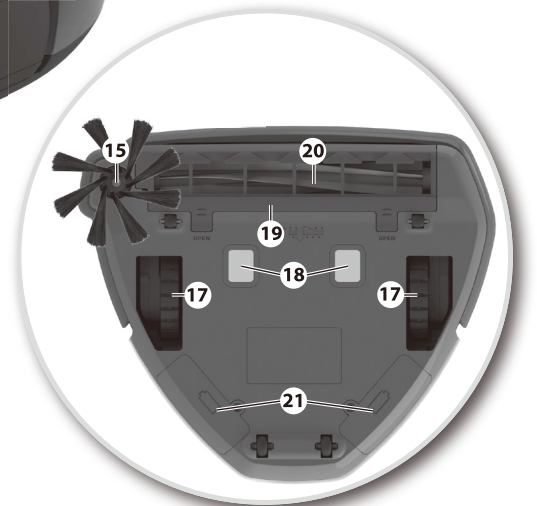
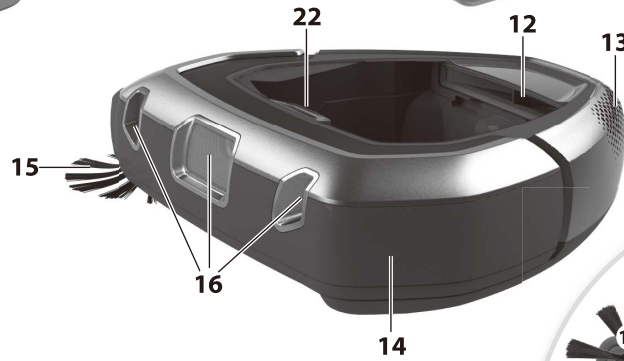
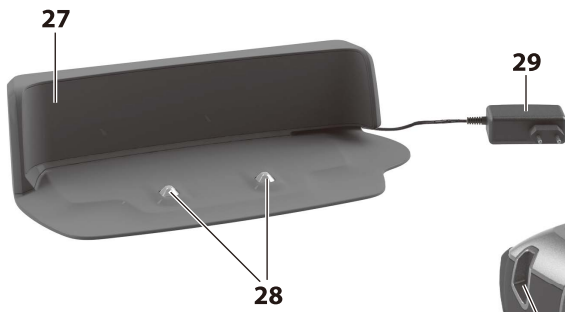
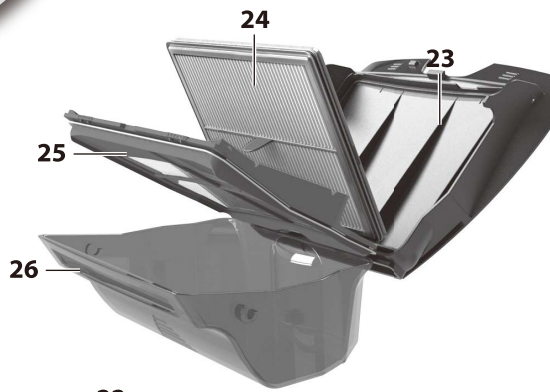

## 繁體中文

## 使用前

- 請打開您的伊萊克斯 PUREi9 掃地機器人吸塵器包裝盒，確認沒有任何遺漏的配件。\*
- 請仔細閱讀說明手冊。
- 請特別注意安全建議的章節。

我們建議您在首次使用之前，先下載「PUREi9」應用程式並更新軟體。

歡迎使用您的伊萊克斯 PUREi9 掃地機器人吸塵器！

## 目錄：

|                  |     |
|------------------|-----|
| 安全注意事項           | 18. |
| 消費者資訊與永續性政策      | 18  |
| 機器人吸塵器使用說明       | 24  |
| 「PUREi9」應用程式連線說明 | 25  |
| 達到最佳清掃效果的技巧      | 27  |
| 清空集塵盒            | 29. |
| 清潔/更換濾網          | 29. |
| 清潔與保養            | 30  |
| 更換電池             | 31. |
| 處理錯誤             | 31. |
| 疑難排解             | 32. |

## 掃地機器人吸塵器說明

- 顯示/控制面板
- 節能 (ECO) 功能按鈕
- SPOT 定點清掃按鈕
- 啟動/暫停按鈕/關閉按鈕 (長按)
- 返回充電座按鈕
- 時鐘
- 集塵盒狀態指示器
- WIFI 連線顯示
- 排程清掃顯示
- 警告顯示
- 電池狀態顯示
- 風扇裝置
- 出風口
- 防撞緩衝器
- 側邊毛刷
- 3D Vision系統 (鏡頭)
- 主滾輪
- 充電接頭
- 滾刷蓋
- 滾刷
- 電池盒
- 集塵盒釋放按鈕
- 集塵盒蓋
- 濾網
- 濾網框架 (與格網)
- 集塵盒
- 充電座
- 充電接頭
- 充電變壓器與電源線

\* 配件可能隨機型而異。

## Bahasa Indonesia

## Sebelum memulai

- Buka kemasan pembersih debu robot Electrolux PUREi9 dan periksa apakah semua aksesoris sudah ada.\*
- Baca buku petunjuk dengan saksama.
- Baca dengan saksama bab Saran keselamatan.

*Kami menyarankan Anda untuk mengunduh aplikasi "PUREi9" dan memperbarui perangkat lunaknya sebelum penggunaan pertama.*

*Sekarang Anda dapat menggunakan pembersih debu robot Electrolux PUREi9!*

## Daftar isi:

|   |    |
|---|----|
| Tindakan pencegahan keamanan                    | 20 |
| Kebijakan keberlanjutan dan informasi pelanggan | 20 |
| Cara menggunakan robot                          | 24 |
| Cara menghubungkan ke APLIKASI "PUREi9"         | 25 |
| Kiat-kiat cara mendapatkan hasil yang terbaik   | 27 |
| Mengosongkan Wadah debu                         | 29 |
| Membersihkan/Mengganti Filter                   | 29 |
| Membersihkan dan memelihara                     | 30 |
| Mengganti baterai                               | 31 |
| Penanganan kesalahan                            | 31 |
| Pemecahan masalah                               | 33 |

## Deskripsi pembersih debu robot Anda

- Tampilan/Panel kontrol
- Tombol fungsi ramah lingkungan
- Tombol pembersih SPOT
- Tombol Jeda/Putar / Tombol mati (tekan lama)
- Tombol halaman utama
- Jam
- Indikator wadah debu
- Indikator koneksi WIFI
- Indikator pembersihan yang terjadwal
- Indikator peringatan
- Indikator status baterai
- Unit kipas
- Ventilasi udara
- Bemper
- Sikat sisi
- Sistem Visi 3D (Kamera)
- Roda utama
- Konektor pengisi daya
- Penutup rol sikat
- Rol sikat
- Kompartemen baterai
- Tombol pelepas wadah debu
- Penutup wadah debu
- Filter
- Bingkai filter (dan jaring mesh)
- Wadah debu
- Dudukan pengisi daya
- Konektor pengisi daya
- Kabel dan adaptor daya

\* Aksesoris mungkin berbeda-beda dari satu model dengan model yang lain.

## 安裝掃地機器人吸塵器

## Pemasangan pembersih debu robot

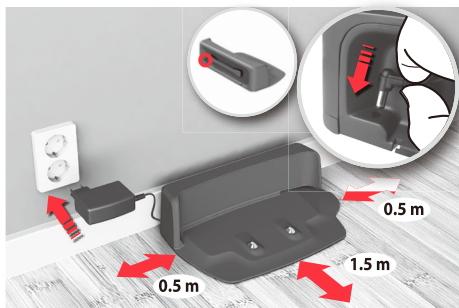

- 將充電座靠牆放置於地板上。將充電變壓器插入充電座側面的電源插孔。將電源線插頭連接至電源插座。將多出的電源線纏繞在充電座的背面。請確認充電座的兩側和前方分別留有 0.5 公尺和 1.5 公尺的空間。  
WiFi 機型：請將充電座放置在 WiFi 路由器的連線範圍內

- Letakkan Dudukan pengisi daya di lantai dekat dinding.**  
Colokkan adaptor ke colokan listrik yang ada di samping dudukan. Hubungkan Steker kabel listrik ke stopkontak utama. Gulung kabel yang terlalu panjang yang ada di belakang dudukan. Pastikan ada area kosong seluas 0,5 m di bagian samping dan 1,5 m di bagian depan Dudukan pengisi daya.  
**Model WiFi:** Letakkan dudukan di dalam jangkauan peruter WiFi.

## 電池/充電狀態

## Status Pengisian Daya/Baterai

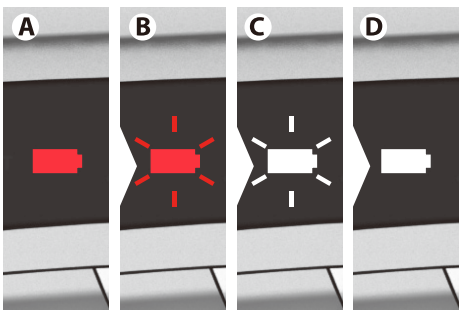

- 紅色電池 (A) 表示機器人吸塵器需要充電。  
閃爍紅光 (B)：機器人吸塵器正在充電 - 低電量。  
閃爍白光 (C)：機器人吸塵器充電量已足以使用。（按下啟動/暫停按鈕來開始清掃。）  
亮起白光 (D)：機器人吸塵器已充飽，就緒可使用。  
完全充電時間約為 3 小時。
- Baterai merah (A)** menunjukkan bawah daya robot harus diisi.  
**Kedipan lampu merah (B)**: Robot sedang mengisi daya – Tingkat pengisian daya rendah.  
**Kedipan lampu putih (C)**: Daya robot sudah cukup terisi dan siap digunakan. (Tekan tombol Putar/Jeda untuk membersihkan.)  
**Lampu putih (D)**: Robot siap untuk digunakan. Waktu pengisian daya penuh adalah ~3 jam.



- 裝上側邊毛刷。  
注意：如果使用掃地機器人吸塵器來清掃鋪有全室地毯的空間時，請拆下側邊毛刷以達到最佳清掃效果。

- Letakkan sikat sisi.**  
**Catatan:** Jika robot digunakan untuk membersihkan ruangan dengan dinding yang dilapisi karpet, lepaskan sikat sisi agar ruangan benar-benar bersih.



- 將機器人吸塵器放在充電座上。  
電池圖示將會閃爍，表示機器人吸塵器正在充電。

- Letakkan robot di Dudukan pengisi daya.**  
Ikon Baterai akan berkedip, menunjukkan bahwa robot sedang mengisi daya.



- 若要維持電池的使用壽命和效能：
  - 未使用時請讓機器人吸塵器隨時保持充電狀態。
  - 在完成清掃後盡快將機器人吸塵器放到充電座上充電。如果過太久才充電，可能會影響電池。

- Untuk menjaga kinerja dan masa pakai baterai:**
  - Selalu isi daya robot saat sedang tidak digunakan.
  - Isi dayanya secepatnya di dudukan pengisi daya setelah siklus pembersihan. Menunggu terlalu lama akan memengaruhi baterai.

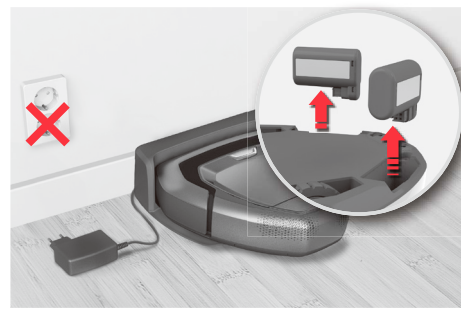

- 存放（未插電）：如果要長時間收儲機器人吸塵器而不充電，請將電池組取出後另外存放。（在取出電池組前先充滿電。）  
若要取出電池組，請參見第 31 頁的說明。
- Penyimpanan (tidak dipasang):** Jika ingin menyimpan robot tanpa mengisi dayanya dalam waktu yang lama, keluarkan baterai dan simpan secara terpisah. (Isi daya baterai sebelum mengeluarkannya).  
*Untuk mengeluarkan baterai, lihat petunjuk halaman 31.*

## 「PUREi9」應用程式連線說明

## Cara menghubungkan ke APLIKASI "PUREi9"



1. 在網路App Store 或 Google Play 商店中下載「PUREi9」應用程式，然後按照指示來建立帳戶並連線至機器人吸塵器。  
注意：請確定手機已連線至家中的 WiFi (2.4 GHz)。

1. Unduh Aplikasi "PUREi9" di App Store atau Google play, lalu ikuti petunjuknya untuk membuat akun dan menghubungkan ke robot.

**Catatan:** Pastikan ponsel terhubung ke WiFi rumah (2.4 GHz).

我們建議您在首次使用之前，先下載此應用程式並更新軟體。

Kami menyarankan Anda untuk mengunduh aplikasi dan memperbarui perangkat lunaknya sebelum penggunaan pertama.



2. 在過程中，此應用程式會請您將機器人吸塵器倒置，以啟動 WiFi 模組和掃描序號條碼 (A) 或手動輸入 (B)。然後請繼續遵循應用程式的指示。  
注意：在將機器人吸塵器翻面之前，請確定機器電源已開啟至少一分鐘以上。

2. Selama proses, aplikasi akan meminta Anda untuk membalik robot ke menghadap ke bawah untuk mengaktifkan modul WiFi dan memindai kode batang nomor seri (A) atau memasukkannya secara manual (B). Selanjutnya ikuti petunjuk berikut dari aplikasi.

**Catatan:** sebelum membalik robot, pastikan robot sudah dinyalakan setidaknya untuk satu menit.



3. 設定完成後，請將機器人吸塵器回復至正常位置。WiFi 標記 (A) 將會亮起，表示機器人吸塵器已連線至您家中的網路。注意：機器人吸塵器的時鐘可能要經過一段時間才會與您的行動裝置自動同步。  
注意：閃爍的 WiFi 標記表示機器人吸塵器正嘗試連線至網路。

3. Jika pengaturan sudah selesai, balikkan robot kembali ke posisi normal. Simbol WiFi (A) akan menyala untuk menunjukkan bahwa robot sudah terhubung ke jaringan rumah Anda. **Catatan:** Mungkin akan memerlukan waktu sekitar beberapa menit hingga robot berhasil menyinkronkan secara otomatis ke perangkat seluler Anda. **Catatan:** Simbol WiFi yang berkedip menunjukkan robot sedang mencoba terhubung ke jaringan.

## 清掃排程

## Jadwal pembersihan



可在應用程式中預定清掃作業（日期和時間）

Pembersihan dapat dijadwalkan di APLIKASI (Tanggal & waktu)

## 清掃模式

## Mode pembersihan

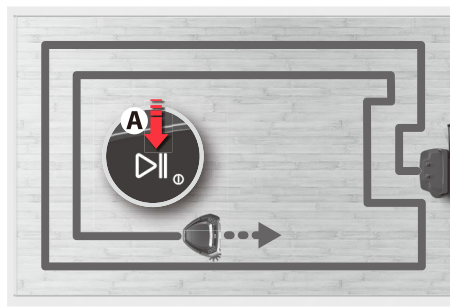

1. 按下啟動/暫停按鈕 (A) 來開始清掃。啟動後幾秒鐘，機器人吸塵器將會開始清掃。機器人吸塵器將會沿著牆壁，開始由外往內清掃。  
注意：按一下「啟動/暫停」(A) 來暫停清掃，或長按此按鈕來終止清掃。

1. Tekan tombol Putar/Jeda (A) untuk memulai pembersihan. Pembersihan akan dimulai setelah beberapa detik proses pemulaian. Robot akan mulai membersihkan di sepanjang dinding, beroperasi dengan arah ke dalam. **Catatan:** Tekan "Putar/Jeda" (A) sebentar untuk menghentikan pembersihan sejenak, atau tekan dan tahan untuk mengakhiri pembersihan.

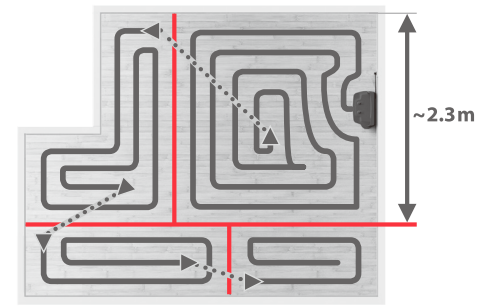

2. 機器人吸塵器會將大房間劃分最多 2 x 2.3 公尺的區塊。  
注意：如果機器人吸塵器從牆壁旁邊開始作業，則清掃模式將更有效率。

2. Ruangan yang luas akan dibagi menjadi sel-sel dengan luas maksimum 2 x 2.3 m.

**Catatan:** Pola pembersihan akan lebih efisien jika robot mulai membersihkan dari samping dinding.

## 自動返座/充電

## Pengisian Daya/Perkaitan Otomatis

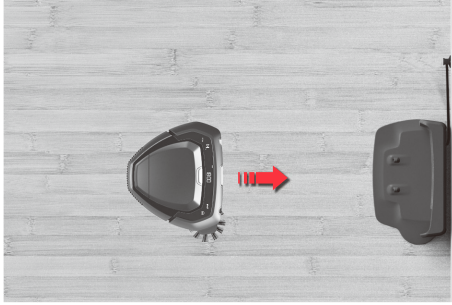

清掃完成時，機器人吸塵器會自動返回充電座。  
注意：如果機器人吸塵器並非從充電座開始掃地動作，則清掃完成時將會返回起始位置。

**Jika pembersihan sudah selesai,** robot secara otomatis kembali ke dudukan pengisi daya.

**Catatan:** Jika robot tidak dimulai dari dudukan pengisi daya, robot akan kembali ke posisi awal jika sudah selesai.

## 在清掃期間自動充電

## Pengisian daya otomatis selama siklus pembersihan

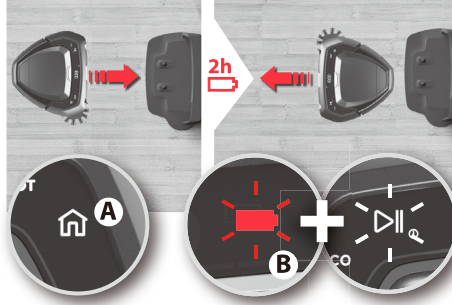

如需在清掃期間充電，返回充電座按鈕會亮起，機器人吸塵器將返回充電座。返回充電座按鈕 (A) 亮起。電池與啟動/暫停按鈕 (B) 會閃爍，表示機器人吸塵器正在充電，完成後將從停止處繼續作業。機器人吸塵器最多將充至 90% 的電量，加速繼續進行清掃為完成的清掃工作。充電時間約為 2 小時。

**Jika pengisian daya harus dilakukan selama pembersihan ini,** tombol halaman utama akan menyala dan robot akan kembali ke dudukan pengisi daya. Tombol halaman utama (A) menyala. Flash tombol Putar/Jeda (B) dan baterai menunjukkan bahwa robot sedang mengisi daya dan akan melanjutkan pada titik berhentinya.

Robot akan mengisi ulang daya hingga 90% agar pembersihan dapat segera dilanjutkan. Waktu pengisian daya adalah ~2 jam.

## 跨越門檻

## Melewati ambang pintu

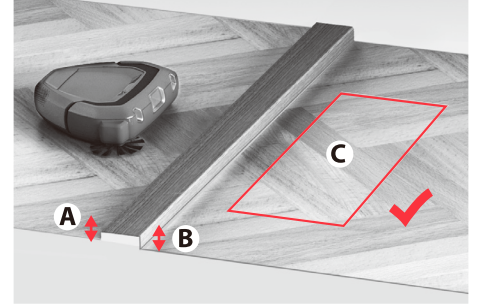

在跨過門檻或爬過任何障礙物之前，機器人吸塵器將會停下並查看：

- 門檻/障礙物兩邊的高度 (A 和 B)
- 另一端區域是否已清空可供清掃 (C)

**Sebelum melewati pintu atau memanjat penghalang,** robot akan berhenti dan memeriksa:

- tinggi (A & B) pada kedua sisi ambang pintu/penghalang
- area di sisi lain bersih untuk melakukan operasi (C)

## 節能模式

## Mode ramah lingkungan



節能模式：若為較簡單的清掃工作，可按下節能 (ECO) 按鈕來降低耗電、延長運作時間和減少噪音量。若未再次按下此按鈕，機器人吸塵器將維持節能模式。

**Mode ramah lingkungan:** Untuk pembersihan yang lebih ringan, tekan tombol ramah lingkungan untuk mengurangi daya, memperpanjang waktu operasi, dan mengurangi tingkat kebisingan. Robot akan tetap dalam mode ramah lingkungan hingga tombol ditekan lagi.

## 返座

## Perkaitan



停止清掃，讓機器人吸塵器返回充電座：  
按下返回充電座按鈕。如果機器人吸塵器並非從充電座開始掃地動作，將會返回起始位置。

**Hentikan pembersihan dan kirim robot ke dudukan pengisi daya:** Tekan tombol Halaman Utama. Jika robot tidak dimulai dari dudukan pengisi daya, robot akan kembali ke posisi mulai.

## 定點清掃

## Pembersihan SPOT



定點清掃 (小區域，約為 1 公尺見方)：將機器人吸塵器面向定點放置，然後按下定點 (SPOT) 按鈕。機器人吸塵器將會清掃此區塊兩次。

**Pembersihan SPOT (area yang kecil ~1 m2):** Letakkan robot menghadap ke spot dan tekan tombol SPOT. Robot akan membersihkan area tersebut dua kali.

## 規劃清掃區域

### Menyiapkan area yang dibersihkan

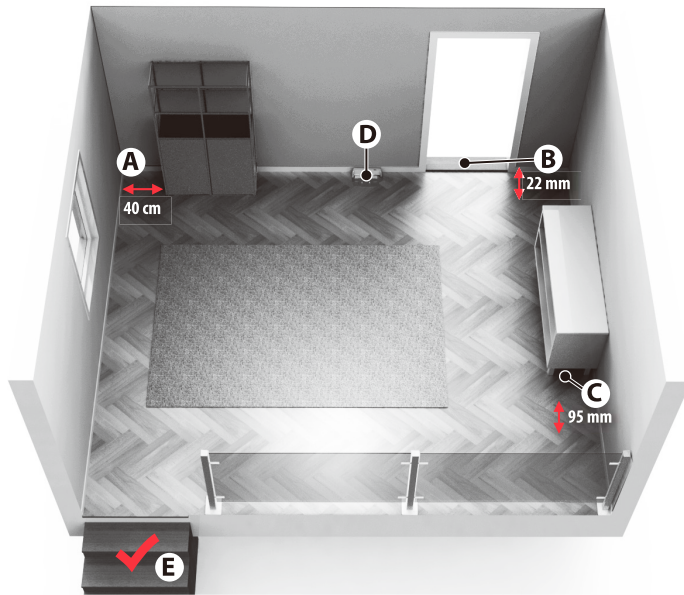

- (A) 在沒有柱腳的家具四周預留 40 公分空間。
- (B) 機器人吸塵器可以輕鬆地跨越最高 2.2 公分的門檻。
- (C) 機器人吸塵器可以在底部留有 9.5 公分以上空間的家具下方清掃。
- (D) 將充電座放置在面對門口的左側。
- (E) 機器人吸塵器能夠偵測樓梯和陡峭的段差。

- (A) Sisakan ruang selebar 40 cm di sekitar perabot yang tidak berkaki.
- (B) Robot dapat dengan mudah melewati ambang pintu dengan ketinggian maksimum 22 mm.
- (C) Robot membersihkan perabot dengan jarak yang lebih dari 95 mm di bawahnya.
- (D) Letakkan dudukan pengisi daya di sebelah kiri pintu.
- (E) Robot mendeteksi tangga dan permukaan yang terjal.

## 規劃清掃區域

進行清掃前，請先從地板上清除小型和脆弱的物體，例如衣服、窗簾繩、紙張和電線。如果本裝置行經並拉動電源線，可能會造成物體從桌面或櫃架上掉落的風險。

如椅子等較高大的物件可留置不動，機器人吸塵器將繞行這些物件進行清掃。

強烈的光線、鏡面牆、落地窗和極為閃亮的物體可能會干擾機器的 3D Vision 路徑掃描規畫系統。

## 限制清掃區域

機器人吸塵器將會清掃自己能夠行經的所有地面。如果想限制清掃區域，只要把門關上，或在路徑上放置障礙物即可。

## 排程清掃任務結束後的集塵盒清除作業

為使排程清掃工作發揮最大的效果，請定期清空集塵盒。

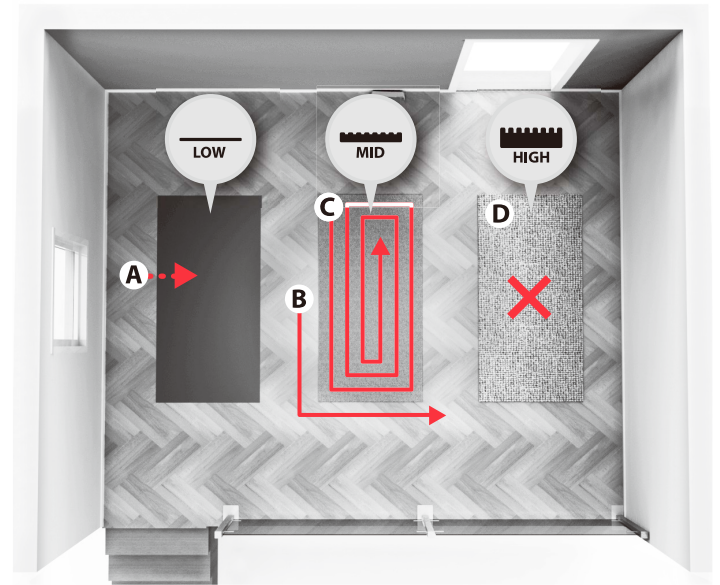

地毯：機器人吸塵器可清掃

- 短絨地毯：(A) 與清掃房間的模式相同
- 中絨地毯：(B) 先清掃地毯周圍 (C)，然後另行清掃地毯本身
- 長絨地毯：(D) 不會進行清掃。當機器人吸塵器行進至邊緣，會繼續進行其餘清掃作業。

**Karpet:** Robot membersihkan

- **karpet dengan tumpukan tipis:** (A) dalam pola yang sama dengan ruangan
- **karpet dengan tumpukan sedang:** (B) pertama di sekitarnya (C) dan kemudian kembali lagi untuk membersihkan karpet secara terpisah
- **karpet dengan tumpukan panjang:** (D) tidak dibersihkan. Saat robot mencapai bagian tepi, selanjutnya robot melakukan tugas pembersihan yang tersisa.

## Menyiapkan area yang dibersihkan

Sebelum membersihkan, singkirkan benda yang lebih kecil dan rapuh seperti pakaian, tali tirai, kertas, dan kabel listrik dari lantai. Jika alat melewati kabel listrik dan menariknya, maka bisa saja kabel listrik terlepas dari meja atau rak.

Benda yang lebih besar/tinggi dapat dibiarkan di lantai karena robot akan membersihkan benda di sekelilingnya.

Cahaya yang sangat terang, Cermin pada dinding, dinding kaca, dan benda yang sangat berkilau dapat mengganggu sistem Visi 3D.

## Membatasi area yang dibersihkan

Robot akan membersihkan semua lantai yang dapat diaksesnya. Untuk membatasi area yang dibersihkan, cukup tutup pintu atau letakkan penghalang di rute robot

## Pengosongan debu di tengah-tengah pembersihan yang terjadwal

Untuk mendapatkan pembersihan yang terjadwal yang paling efektif, kosongkan wadah debu secara rutin.



搬移機器人吸塵器時務必正面朝上，兩手同時拿取。手動搬移機器人吸塵器：  
不建議在清掃期間移動機器人吸塵器，因為機器可能會從頭開始進行清掃。

**Selalu angkat robot dengan dua tangan, menjaga bagian depannya di atas. Pemindahan robot secara manual:**

Pemindahan robot selama proses pembersihan tidak dianjurkan karena pembersihan mungkin akan diulang dari awal lagi.

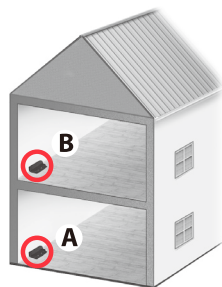

若要清掃一層樓以上的房子，在每層樓設置額外充電座會更方便。(ANC:406000071)

**Membersihkan rumah yang memiliki lebih dari satu lantai dapat difasilitasi menggunakan dudukan pengisi daya tambahan di setiap lantai.**

(ANC: 406000071)

**將機器人吸塵器關機 / Matikan/Non aktifkan Robot vacuum anda**

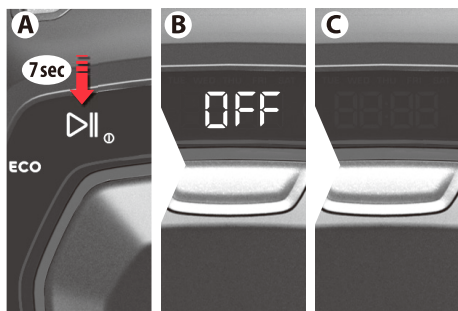

將機器人吸塵器關機: 若您將長時間不使用機器人吸塵器，也可以按照以下的步驟將機器人吸塵器完全關機。

- 長按住啟動/暫停按鈕大約7秒 (A)。
- 顯示螢幕上會出現「OFF」的圖示 (B)。
- 當顯示螢幕關閉，表示機器人吸塵器已完成關機 (C)

**Matikan/Non aktifkan Robot vacuum anda:** Ikuti langkah berikut ini jika anda ingin menonaktifkan robot untuk sementara waktu:

- Tekan tombol play selama kurang lebih 7 detik (Gambar A).
- Simbol "off" akan muncul pada layar (Gambar B).
- Pada saat layar menjadi gelap, robot telah berhasil di non aktifkan (Gambar C).

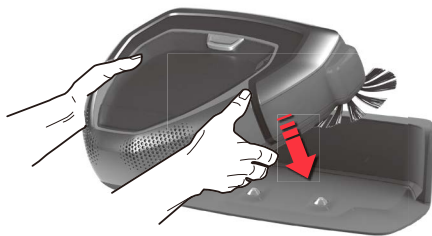

需要重新啟動機器人吸塵器時，請重新將機器人吸塵器置於充電座上。當機器人吸塵器位在充電座上時，您也可以直接透過以上流程將機器人吸塵器關機。在此情況下，若您需要重新啟動時，請將機器人抬起再放回充電座，即可完成開機。

**Untuk restart dan menggunakan robot ini kembali, letakan dan lakukan kembali pengisian baterai.** Anda juga bisa menonaktifkan robot pada tempat pengisian baterai, anda hanya perlu mengangkat dan letakan kembali di tempat pengisian baterai untuk digunakan kembali.

## 清空集塵盒

### Mengosongkan Wadah debu

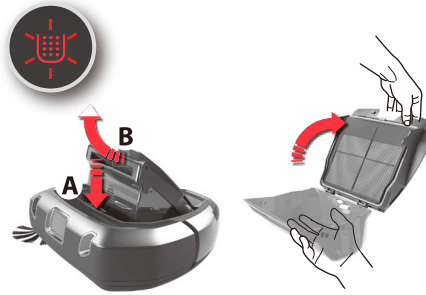

1. 定期或在集塵盒圖示亮起時清空集塵盒。如果集塵盒已清空，但集塵盒標誌仍亮起，請清潔濾網。



1. Kosongkan wadah debu secara rutin atau jika ikon wadah debu menyala.



Jika simbol tong sampah menyala saat tong sampah kosong, maka Anda harus membersihkan filter.

2. 按下釋放按鈕 (A)，然後往上擺動集塵盒以取出盒子 (B)。往上擺動以開啟蓋子。將集塵盒內的塵屑清空並倒入垃圾桶。注意：集塵盒圖示會閃爍，顯示集塵盒已取出或位置錯誤。

2. Tekan tombol Lepaskan (A), keluarkan Wadah debu dengan mengayunkannya ke atas (B). Buka penutup dengan mengayunkannya ke atas. Buang kotoran di wadah debu ke tempat sampah. **Catatan:** Ikon wadah debu yang berkedip menunjukkan bawa Wadah debu telah dikeluarkan, atau tidak berada dalam posisi yang pas.

3. 清空集塵盒後，請關上蓋子，將盒子放回原位，再將集塵盒裝回機器人吸塵器中。注意：若在未正確組裝集塵盒時按下啟動/暫停按鈕，集塵盒圖示將會閃爍。請正確地重新安裝集塵盒。

3. Setelah mengosongkan wadah, tutup penutup dan letakkan kembali di tempatnya. Pasang kembali Wadah debu ke dalam robot. **Catatan:** Jika Wadah debu tidak dipasang dengan benar dan tombol Putar/Jeda ditekan, ikon wadah debu akan berkedip. Pasang kembali Wadah debu dengan benar.

## 清潔濾網

### Membersihkan Filter

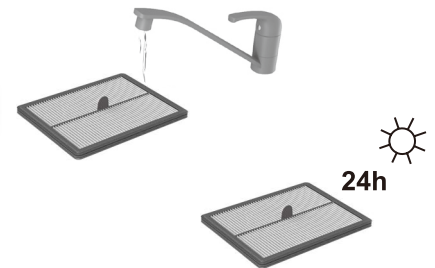
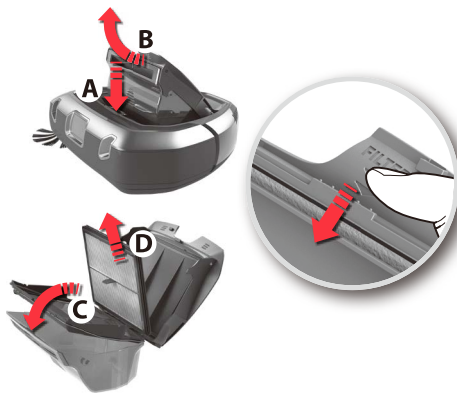

1. 為了達到最佳效果，我們建議每清掃 5 次就清潔一次濾網，以及每 6 個月更換一次濾網。（參考：ERK2）

1. Untuk mendapatkan kinerja yang terbaik, kami menyarankan untuk membersihkan filter setiap pembersihan ke-5 dan menggantinya setiap 6 bulan sekali. (Ref: ERK2)

2. 移除濾網：往上方擺動集塵盒以取出盒子 (B)。往上方擺動以開啟蓋子。往下方擺動濾網框架 (C)。移除濾網 (D)。

2. Keluarkan filter: Keluarkan Wadah debu dengan mengayunkannya ke atas (B). Buka penutup dengan mengayunkannya ke atas. Ayunkan Bingkai filter ke bawah (C). Keluarkan filter (D).

3. 用冷水沖洗濾網。輕敲濾網框架以去除水分。讓濾網陰乾 24 小時，再裝回機器中。

3. Basuh filter dengan air dingin. Ketuk bingkai filter untuk mengeluarkan air. Biarkan filter selama 24 jam hingga mengering sebelum meletakkannya kembali ke mesin.

## 清潔 3D Vision 系統 (鏡頭)

## Membersihkan Sistem Visi 3D (Kamera)

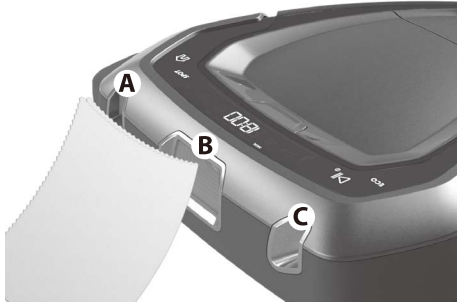

如果視窗 (A、B、C) 保持乾淨無刮痕，則 3D Vision 系統可發揮最佳效果。使用乾燥軟布來清潔微塵。如果髒污嚴重，可使用溫和清潔劑來清潔。

**Sistem Visi 3D akan berfungsi dengan maksimum jika jendela (A, B, C) dijaga tetap bersih dan bebas dari goresan.**

Bersihkan dari debu yang tipis menggunakan kain kering yang lembut. Jika Anda melihatnya sudah sangat kotor, Anda dapat menggunakan detergen yang ringan untuk membersihkannya.

## 清潔側邊毛刷

## Membersihkan Sikat sisi

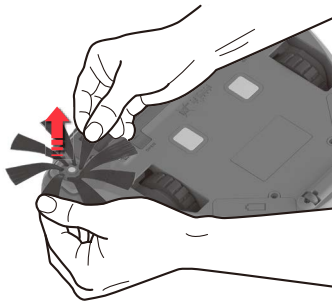

拉動側邊毛刷以將其取下。清潔側邊毛刷。將側邊毛刷重新裝回刷座孔。側邊毛刷可以更換。(參考: ERK2/EBSB2)

**Tarik Sikat sisi untuk melepaskannya.** Bersihkan Sikat sisi. Pasang kembali Sikat sisi ke stopkontak. Sikat sisi dapat diganti. (Ref: ERK2/EBSB2)

## 清潔滾輪

## Membersihkan Roda

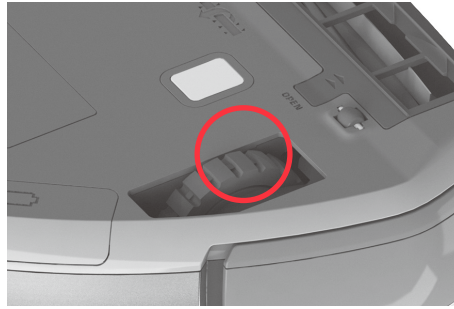

1. 清除主滾輪上的纏繞毛髮等異物，確保能夠順暢轉動。

**1. Ambil rambut yang terjerat atau sejenisnya dari roda utama sehingga roda dapat berjalan dengan bebas.**

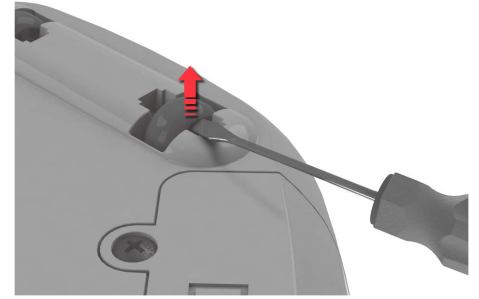

2. 如果小滾輪卡住，請使用小型螺絲起子謹慎地將滾輪取出並加以清潔。

**2. Jika roda yang kecil tidak dapat bergerak,** lepaskan dengan hati-hati menggunakan obeng kecil dan bersihkan roda.

## 清潔滾刷

## Membersihkan Rol sikat



1. 按壓兩個門扣，並將蓋子往前滑動以移除滾刷蓋。

**1. Tekan kedua pengait dan geser penutup ke depan untuk melepas penutup rol sikat.**



2. 拉出滾刷，然後清理刷子和軸承。用剪刀剪斷纏繞的毛髮／絲線來加以清除。以相反的順序裝回滾刷。滾刷可以更換。(參考: ERK2)

**2. Tarik keluar Rol sikat dan bersihkan sikat dan bantalannya.** Ambil benang yang terjerat dengan memotongnya menggunakan gunting. Pasang kembali dengan urutan yang terbalik. Rol sikat dapat diganti. (Ref: ERK2)

## 清潔空氣管道

### Membersihkan Saluran udara



取出集塵盒。清除空氣管道中堵塞的碎屑。將集塵盒裝回原位。

**Mengeluarkan wadah debu.** Membersihkan kotoran yang tersumbat di saluran udara. Letakkan kembali wadah debu ke tempatnya.

## 更換電池組

### Mengganti baterai

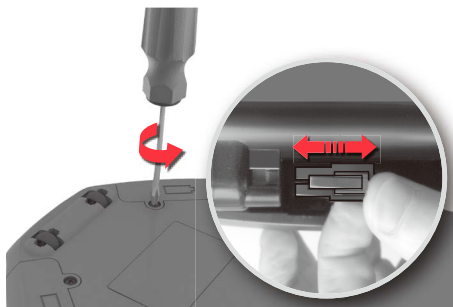

1. 電池盒位於機器人吸塵器的底部。使用螺絲起子 (PH2) 來轉開電池盒蓋上的螺絲。更換電池組，然後裝回電池盒蓋。

**⚠️ 注意！** 請務必同時更換兩個成對的電池組。

1. **Kompartemen baterai diletakkan di sisi bawah robot.** Gunakan obeng (PH2) untuk membuka penutup kompartemen baterai. Ganti kemasan baterai dan pasang kembali penutup kompartemen baterai.

**⚠️ Peringatan!** Pastikan Anda mengganti dua kemasan baterai dalam waktu yang bersamaan.



2. 請只使用原廠供應商的電池組。棄置機器之前，務必先將電池組取出並安全地棄置。  
(ANC:405 537 959/0)

2. **Hanya gunakan baterai pasokan yang asli.** Baterai harus dikeluarkan dan dibuang dengan aman sebelum membuang mesin.  
(ANC: 405 537 959/0)

## 清潔充電接頭

### Membersihkan penghubung pengisi tenaga



請經常使用乾燥柔軟的布擦拭充電座以及機身背面的充電接頭（如紅圈指示之位置）

**Gunakan kain kering dan lembut untuk membersihkan secara rutin** tempat penghubung pengisi tenaga di dudukan dan dibawah alatnya.

## 處理錯誤

### Penanganan kesalahan



1. 如果發生錯誤，機器人吸塵器會停止清掃。警告圖示會閃爍，且顯示幕上將顯示由「E:」開頭的錯誤代碼。也會語音說明錯誤。發生錯誤後，按下任何按鈕皆可重播語音訊息。

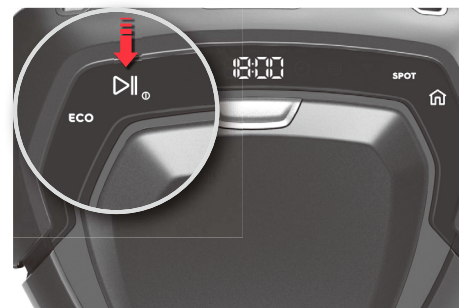

1. **Robot berhenti membersihkan jika ada kesalahan yang terjadi.** Ikon peringatan akan berkedip dan digit "E:" yang diikuti oleh kode kesalahan akan muncul pada tampilan. Speaker juga akan menjelaskan kesalahan tersebut. Setelah terjadi kesalahan, tekan tombol apa pun untuk memutar kembali pesan audio.



2. 錯誤解決後，請按下啟動/暫停按鈕來開始清掃。注意：如需完整的錯誤代碼清單和解決方法，請參閱「疑難排解」中的說明。

2. **Setelah kesalahan berhasil diselesaikan,** tekan tombol Putar/Jeda untuk memulai pembersihan.  
**Catatan:** Untuk melihat daftar lengkap kode kesalahan dan solusinya, lihat petunjuk di bagian "Pemecahan Masalah".

## 疑難排解

| 問題                      | 錯誤代碼  | 原因  | 解決方法   |
|-------------------------|---|---|--|
| 顯示器空白。                  | -   | 電池沒電。   | 將電池充電。   |
| 機器人吸塵器未啟動。              |  | 集塵盒未裝入或未正確關上。   | 將集塵盒裝入機器人吸塵器、正確地關上蓋子。  |
|                         |   | <br>(x3)<br>機器人吸塵器被舉起。 | 啟動前請將機器人吸塵器放置在地板上。   |
| 機器人吸塵器不會動/未適當清潔。        | E:10  | 緩衝器卡住了  | 請確認緩衝器可適當移動，並清除可能造成阻塞的碎屑。  |
|                         | E:11  | 右輪卡住了   | 確認所有零件皆順暢轉動。視情況清潔並移除零件上纏繞的毛髮線頭。請更換損壞的滾刷或側邊毛刷。請參閱「清潔與保養」(第 30 頁)。 |
|                         | E:12  | 左輪卡住了   |  |
|                         | E:13  | 滾刷卡住了   |  |
|                         | E:14  | 側邊毛刷卡住了   |  |
|                         | E:15  | 機器人吸塵器卡住了或是無法導航。  | 將機器人吸塵器抬起，並放在沒有阻礙的地方。請參閱「達到最佳清掃效果的技巧」(第 27 頁)。                   |
| E:16                    | 3D Vision 系統阻塞或髒污。  | 清潔 3D Vision 系統，並確定沒有任何物體阻礙視線。請參閱「清潔與保養」(第 30 頁)。   |  |
|                         |  | 集塵盒已滿或阻塞。   | 清空和/或清潔集塵盒。請參閱「清空集塵盒」(第 29 頁)。                                   |
|                         |   | E:17  | 機器人吸塵器在太滑的表面上運作。   |
| 充電指示燈未亮                 | -   | 電源線與充電/變壓器未正確組裝和/或連接至電源插座。  | 將充電器插頭連接至充電座。將電源線連接至電源插座。確認機器人吸塵器上的充電接點已與充電座連接。                  |
|                         |   | 機器人吸塵器上的充電接點與充電座未連接。  | 確認插頭和電源線並未損壞。  |
| 電池很快就耗盡                 | -   | 電池使用壽命期限已到。   | 請更換 2 個電池組。請參閱「更換電池」(第 31 頁)。                                    |
| 電池相關問題                  | E:20  | 使用了錯誤的充電座。  | 請只使用機器人吸塵器隨附的伊萊克斯原廠充電座。若充電座需要更換，請使用伊萊克斯充電座 (ANC:406000071)。      |
|                         | E:21  | 使用時電池出現異常。  | 請更換 2 個電池組。請參閱「更換電池」(第 31 頁)。                                    |
|                         | E:22  | 產品溫度過高。   | 將機器人吸塵器放在充電座以外的地方靜置 6 小時。  |
|                         | E:23  | 電池並未正確連接至機器人吸塵器。  | 將電池連接至機器人吸塵器。請參閱「更換電池」(第 31 頁)。                                  |
| 未顯示時間。                  | --:--   | 未設定目前的時間。   | 機器人吸塵器連線至 WiFi 網路時，會自動設定時間。                                      |
| 機器人吸塵器顯示的時間錯誤。          | -   | 機器人吸塵器並未從 WiFi 網路接收到更新時間。   | 確認機器人吸塵器已連線至 WiFi 網路，並等待機器人吸塵器接收到正確時間。如果時間未在 24 小時內更新，請重新執行啟動程序。 |
| 房間尚未清掃乾淨，但機器人吸塵器已返回充電座。 | -   | 機器人吸塵器返回充電座，是要為電池充電。  | 電池充電完後，機器人吸塵器會自動持續清潔程序。  |
| 機器人吸塵器吸了水。              | -   | -   | 必須與伊萊克斯客服中心聯繫更換馬達。因水滲入造成馬達損壞並未在保固範圍內。                            |

| 問題   | 錯誤代碼 | 原因       | 解決方法          |
|------|------|----------|---------------|
| 軟體問題 | E:30 | 軟體未正常運作。 | 請更新機器人吸塵器的軟體。 |
|      | E:31 | 軟體升級失敗。  | 請重新執行軟體更新。    |
| 需要服務 | E:40 | -        | 請聯絡伊萊克斯客服中心。  |
| 系統錯誤 | E:41 | 內部錯誤。    | 請重新啟動所需的操作。   |
|      | E:42 |          |               |

如果有任何其他問題，請參見應用程式或我們網站上的「服務」頁面。

## 耗材與配件

 客服專線：0800-888-259

 PUREi9 效能套件  
Ref: ERK2  
PNC: 9001677674

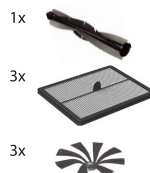

 PUREi9 電動刷  
REF: EBSB2  
PNC: 9001683938



 充電座  
ANC: 406000071



 電池組  
ANC: 405 537 959/0



配件組合會依據各國家販售型號而有所不同，請洽詢各國家之客服專線或官網資訊。

## Pemecahan masalah

| Masalah   | Kode Kesalahan  | Penyebab  | Solusi   |
|---|---|---|--|
| Layar kosong.                                       | -   | Baterai kosong.   | Isi daya baterai.  |
| Robot tidak mulai.                                  |    | Wadah debu tidak ada atau tidak tertutup dengan benar.                                      | Letakkan Wadah debu ke dalam robot, kemudian tutup penutup dengan benar.   |
|   |   | Robot diangkat.   | Letakkan robot di lantai sebelum memulai.  |
| Robot tidak bergerak/<br>membersihkan dengan benar. | E:10  | Bemper macet  | Pastikan bumper bisa bergerak dengan benar dan buang kotoran yang mungkin menghalanginya.  |
|   | E:11  | Roda kanan macet  | Periksa apakah semua komponen dapat bergerak bebas. Bersihkan dan buang benang yang kusut dari bagian jika diperlukan. Ganti Tol sikat atau Sikat sisi jika rusak. <i>Periksa "Pembersihan dan pemeliharaan" halaman 30.</i> |
|   | E:12  | Roda kiri macet   |  |
|   | E:13  | Rol sikat macet   |  |
|   | E:14  | Sikat sisi macet  |  |
|   | E:15  | Robot ini macet atau tidak dapat dinavigasi.  | Angkat dan letakkan robot di tempat robot dapat bergerak bebas. <i>Lihat "Kiat-kiat cara mendapatkan hasil yang terbaik" halaman 27.</i>   |
|   | E:16  | Sistem Visi 3D terhalang atau berdebu.  | Bersihkan Sistem Visi 3D dan pastikan tidak ada yang menghalangi pandangan. <i>Lihat "Pembersihan dan pemeliharaan" halaman 30.</i>  |
|   |  | Wadah debu penuh atau tersumbat.  | Kosongkan dan/atau bersihkan Wadah Debu. <i>Lihat "Mengosongkan Wadah debu" halaman 29.</i>  |
| E:17  | Robot beroperasi pada permukaan yang sangat licin.                                  | Pindahkan robot dan pengisi daya ke lokasi baru dan mulai lagi.                             |  |
| Tidak ada tanda pengisian daya                      | -   | Kabel listrik dan adaptor tidak dipasang dengan benar dan/atau terhubung ke sumber listrik. | Hubungkan konektor adaptor ke Dudukan pengisi daya. Hubungkan kabel daya ke sumber listrik. Pastikan Pelat pengisi daya pada robot dan Dudukan pengisi daya terhubung.   |
|   |   | Pelat pengisi daya pada robot dan Dudukan pengisi daya tidak terhubung.                     | Periksa steker dan kabel tidak rusak.  |
| Baterai cepat habis                                 | -   | Masa pakai baterai habis.   | Ganti 2 kemasan baterai. <i>Lihat "Mengisi daya baterai" halaman 31.</i>   |
| Masalah terkait baterai                             | E:20  | Dudukan pengisi daya yang salah digunakan.  | Hanya gunakan Dudukan pengisi daya Electrolux yang asli, yang disertakan dengan robot. Jika Dudukan pengisi daya perlu diganti; gunakan Dudukan pengisi daya Electrolux (ANC: 406000071).                                    |
|   | E:21  | Baterai tidak berfungsi saat digunakan.   | Ganti 2 kemasan baterai. <i>Lihat "Mengisi daya baterai" halaman 31.</i>   |
|   | E:22  | Suhu produk terlalu tinggi.   | Biarkan robot berhenti di luar stasiun pengisi daya selama 6 jam.  |
|   | E:23  | Baterai tidak terhubung ke robot dengan benar.  | Hubungkan baterai ke robot. <i>Lihat "Mengisi daya baterai" halaman 31.</i>  |

| Masalah  | Kode Kesalahan | Penyebab  | Solusi   |
|--|----------------|---|--|
| Waktu tidak ditampilkan.   | - - - -        | Waktu saat ini tidak diatur.                                      | Saat robot terhubung ke WiFi, waktu akan secara otomatis diatur.   |
| Waktu yang salah ditampilkan pada robot.   |                | Robot belum menerima waktu yang diperbarui dari jaringan WiFi.    | Pastikan robot terhubung ke jaringan WiFi dan tunggu sampai robot menerima waktu yang tepat. Jika tidak ada pembaruan dalam waktu 24, ulangi prosedur orientasi. |
| Ruangan tidak dibersihkan dengan benar, tetapi robot kembali ke Dudukan pengisi daya.              | -              | Robot kembali ke Dudukan pengisi daya untuk mengisi daya baterai. | Robot akan otomatis melanjutkan program pembersihan segera setelah baterai diisi ulang.  |
| Air tersedot masuk ke robot.   | -              | -   | Anda perlu mengganti motor ke pusat servis resmi Electrolux. Kerusakan motor yang disebabkan karena masuknya air tidak dilindungi oleh garansi.                  |
| Masalah pada perangkat lunak   | E:30           | Perangkat lunak tidak berfungsi dengan benar.                     | Perbarui perangkat lunak robot.  |
|  | E:31           | Pemutakhiran perangkat lunak gagal.                               | Ulangi untuk memperbarui perangkat lunak.  |
| Harus diservis   | E:40           | -   | Hubungi pusat servis resmi Electrolux.   |
| Kesalahan sistem   | E:41           | Kesalahan internal  | Silakan mulai ulang operasi yang diinginkan.   |
|  | E:42           |   |  |
| <b>Untuk masalah lebih lanjut, silakan buka bagian layanan di aplikasi atau di situs web kami.</b> |                |   |  |

## Benda Habis Pakai &amp; Aksesori

 [www.electrolux.com/shop](http://www.electrolux.com/shop)

 Kit Kinerja PUREi9  
Ref: ERK2  
PNC: 9001677674

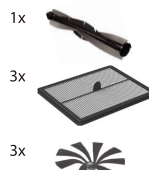

 Sikat listrik PUREi9  
REF: EBSB2  
PNC: 9001683938



 Dudukan pengisi daya  
ANC: 406000071



 Kemasan baterai  
ANC: 405 537 959/0



## 안전 주의 사항

8세 이상 어린이 및 신체, 감각 또는 지적 능력이 낮거나 경험과 지식이 부족한 사람도 안전한 제품 사용과 관련된 지시 또는 감독을 받은 경우나 제품 사용과 관련된 위험을 이해하는 경우 이 제품을 사용할 수 있습니다.

로봇을 실내 환경에서 일반 진공 청소기로만 사용하십시오.

로봇은 건조한 장소에 보관하십시오.

모든 정비나 수리는 공인 Electrolux 서비스 센터에서 수행해야 합니다.

로봇을 세척하거나 유지보수하려면 먼저 로봇을 충전기에서 분리하십시오.

어린이가 제품을 갖고 놀지 못하게 해야 합니다.

질식을 방지하기 위해 아이들이 비닐이나 종이 백과 같은 모든 포장재에 접근할 수 없도록 하십시오.

로봇은 특정 전압에 맞게 설계되어 있습니다. 충전 어댑터의 명판에 명시된 대로 공급 전압이 동일한 지 확인하십시오.

로봇에 맞게 설계된 정품 충전대 및 어댑터만 사용하십시오.

## 다음과 같은 환경에서 로봇을 사용하지 마십시오.

- 젖은 장소
- 가연성 가스 등이 인접한 경우
- 제품이 손상된 징후가 보이는 경우.
- 날카로운 물체 또는 액체가 있는 경우.
- 뜨겁거나 식은 재, 불씨가 있는 담배 꽂초 등이 있는 경우.
- 석고, 콘크리트 먼지, 밀가루, 뜨겁거나 식은 재와 같은 미세한 먼지가 있는 경우
- 직사광선에 로봇을 방치하지 마십시오.
- 강한 열기에 로봇을 노출시키지 마십시오.
- 내장된 배터리 팩을 분해하거나 단락시키거나 금속 표면에 올려두면 안됩니다. 로봇에 맞게 설계된 배터리 팩만 사용하십시오.
- 제품을 폐기하기 전에 먼저 배터리를 분리해야 합니다.
- 배터리를 분리할 때는 콘센트에 제품이 연결되어 있지 않아야 합니다.
- 배터리는 안전하게 폐기해야 합니다.

- 필터 없이는 로봇을 사용하지 마십시오.
- 청소기가 켜져있고 브러쉬 롤이 회전하는 중에 브러쉬 롤에 손을 대지 마십시오. 로봇이 작동하는 중에 바퀴에 손을 대지 마십시오.

로봇을 사용할 때 위의 권장 사항을 따르지 않을 경우 심각한 부상을 입거나 제품 손상을 가져올 수 있습니다. 이러한 부상 또는 손상에 대해서는 Electrolux의 보증 서비스를 받을 수 없습니다.

배터리의 수명은 로봇 사용 시간 및 횟수에 따라 달라지기 때문에 배터리 작동 시간 단축에는 적용되지 않습니다.

청소를 하기 전에 의류, 커튼 줄, 종이 및 전원 코드와 같이 작고 약한 물체는 치우십시오. 로봇이 전원 코드 위로 지나면서 전원 코드를 끌어 당길 경우 탁자나 선반 위의 물체가 떨어질 위험이 있습니다.

로봇은 이런 식으로 커다란 물체를 옮기도록 설계되어 있지 않습니다. 의자와 같은 물체는 바닥에 그대로 두면 로봇이 빙 돌아가며 청소합니다.

강한 빛, 거울이 부착된 벽, 바닥에서 천정까지 이어져 있는 창 및 아주 밝은 물체는 3D 비전 시스템에 오류를 유발할 수 있습니다.

## 홈페이지를 방문해 보십시오.



홈페이지를 방문해 보십시오.  
사용법에 대한 조언, 브로셔,  
문제 해결 방법, 서비스 정보 확보:



[www.electrolux.co.kr](http://www.electrolux.co.kr)



제품 액세서리 및 소모품 구입:  
[www.electroluxshop.co.kr](http://www.electroluxshop.co.kr)

## Electrolux 배터리 제품의 작동, 충전 및 보관 권장 환경

### 1. 작동, 충전 및 보관 조건

이 제품은 일반적인 가정 환경에서 사용하기 위한 것이며 비정상적인 온도에 노출되어선 안됩니다.

제품 내부 부품을 보호하려면 다음과 같은 환경에서의 보관, 충전 또는 작동을 피해야 합니다.

- 주변온도가 10 °C 미만이나 30 °C 초과하는 경우.
- 10 °C 미만이나 30 °C 초과하는 온도에서 제품을 보관한 경우, 사용하기 전에 내부 구성품이 예열되고 건조될 수 있도록 몇 시간 기다려주십시오. 온도 범위를 벗어나 사용 및 보관할 경우 제품이 손상되거나 수명이 짧아질 수 있습니다.
- 20% 미만이나 80% 이상의 습도(비응축)

최소 24시간 이상 제품을 충전해야 하는 경우.

- 최초 사용 전.
- 장기간 보관하기 전. (오랜 시간 보관하기 전에 로봇에서 배터리를 분리하십시오.)
- 장기간 보관 후

### 2. 결로 현상 경고

다음과 같은 조건에서 제품 내부에 결로 현상이 일어날 수 있습니다.

- 추운 곳에서 따뜻한 장소로 장치가 이동한 경우
- 습도가 매우 높은 경우.
- 추운 방을 난방한 뒤.

사용하기 전에 제품의 내부 구성품이 예열되고 건조될 수 있도록 몇 시간 기다려주십시오.

### 3. 배터리 수명 및 성능을 보존하려면,

- 사용하지 않을 때는 항상 로봇을 충전하십시오.
- 청소를 한 뒤에는 최대한 빨리 충전하십시오. 시간이 너무 지나면 배터리에 영향을 줄 수 있습니다.

## 환경 문제

 이 기호는 이 제품을 일반 가정용 폐기물로 버릴 수 없는 내장형 충전지가 들어 있음을 나타냅니다.

 제품 또는 포장에 이 기호가 있으면 이 제품을 가정용 폐기물로 처리할 수 없다는 표시입니다.

제품을 재활용하려면 안전하고 전문적인 방식으로 배터리 및 전기 부품을 분리할 수 있는 공식 수거 장소 또는 Electrolux 서비스 센터에 가져가십시오. 전기 제품 및 충전지 분리 수거를 위한 거주 국가의 규정에 따르십시오.

## 고객 관리 및 서비스

Electrolux 서비스 센터에 연락할 때는 다음 데이터를 준비하십시오.

- 모델 번호
- PNC 번호
- 일련 번호

해당 정보는 명판에 적혀 있습니다.

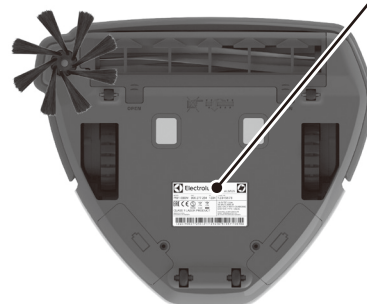
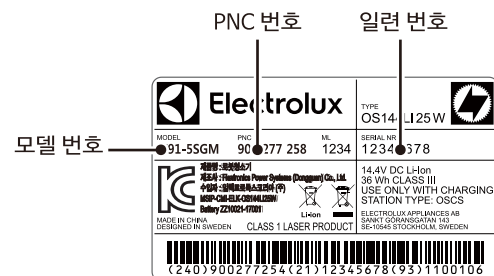

## ข้อควรระวังเพื่อความปลอดภัย

เด็กที่อายุตั้งแต่ 8 ปีขึ้นไปและบุคคลผู้มีความบกพร่องทางร่างกาย ทางประสาทสัมผัสหรือทางจิต หรือผู้ที่มีความประสพการณ์และความรู้ สามารถใช้งานหุ่นยนต์ดูดฝุ่นนี้ได้ก็ต่อเมื่ออยู่ภายใต้การดูแลหรือการแนะนำในการใช้หุ่นยนต์ดูดฝุ่นด้วยวิธีการที่ปลอดภัย และตระหนักถึงอันตรายที่เกี่ยวข้อง ควรใช้หุ่นยนต์ดูดฝุ่นสำหรับดูดฝุ่นทั่วไปในสภาพแวดล้อมภายในบ้าน/ในร่มเท่านั้น

ควรใช้หุ่นยนต์ดูดฝุ่นสำหรับดูดฝุ่นทั่วไปในสภาพแวดล้อมภายในบ้าน/ในร่มเท่านั้น

ตรวจสอบให้แน่ใจว่าเก็บหุ่นยนต์ดูดฝุ่นไว้ในที่แห้ง

บริการหรือการซ่อมบำรุงทั้งหมดจะต้องดำเนินการโดยศูนย์บริการอย่างเป็นทางการของอีเลคโตรลักซ์

ถอดหุ่นยนต์ดูดฝุ่นออกจากแท่นชาร์จก่อนทำความสะอาดหรือซ่อมบำรุง

อย่าปล่อยให้เด็กเล่นหุ่นยนต์ดูดฝุ่น

เก็บวัสดุบรรจุภัณฑ์ทั้งหมด เช่น พลาสติก หรือถุงผ้าให้ห่างจากมือเด็กเพื่อป้องกันการขาดอากาศหายใจ

หุ่นยนต์ดูดฝุ่นนี้ออกแบบมาเพื่อรองรับแรงดันไฟฟ้าที่ระบุ โปรดตรวจสอบว่าแรงดันไฟฟ้าที่จ่ายเข้าเครื่องของคุณตรงกันกับแรงดันไฟฟ้าที่ระบุบนแผ่นป้ายระบุค่าพิกัดของแท่นชาร์จ

ให้ใช้เฉพาะแท่นชาร์จและอะแดปเตอร์ของแท้ที่ออกแบบมาสำหรับหุ่นยนต์ดูดฝุ่นรุ่นนี้เท่านั้น

### ห้ามใช้หุ่นยนต์ดูดฝุ่นในกรณีต่อไปนี้

- ในพื้นที่เปียก
- ใกล้กับก๊าซไวไฟ ฯลฯ
- เมื่อผลิตภัณฑ์มีร่องรอยของความเสียหาย
- ใช้ดูดขงมีคมหรือของเหลว
- ใช้ดูดซีเมนต์ทั้งร้อนและเย็น ก้นบุหรี่ที่ติดไฟ ฯลฯ
- ใช้ดูดฝุ่นผงละเอียด เช่น ปูนปลาสเตอร์ คอนกรีต ผงแป้ง ซีเมนต์ทั้งร้อนและเย็น
- อย่าวางหุ่นยนต์ดูดฝุ่นให้สัมผัสกับแสงแดดโดยตรง
- หลีกเลี่ยงการวางหุ่นยนต์ดูดฝุ่นให้สัมผัสกับความร้อนจัด
- อย่าถอดหรือชุดแบตเตอรี่ภายในเครื่อง อาจทำให้เกิดการลัดวงจร หรือวางไว้บนพื้นผิวโลหะ ใช้เฉพาะชุดแบตเตอรี่ที่ออกแบบมาสำหรับหุ่นยนต์ดูดฝุ่นเท่านั้น
- ถอดแบตเตอรี่ออกก่อนทิ้งผลิตภัณฑ์นี้

- ถอดปลั๊กเครื่องใช้ไฟฟ้านี้ออกก่อนเสมอเมื่อถอดแบตเตอรี่
- แบตเตอรี่ต้องนำไปทิ้งอย่างปลอดภัย
- ห้ามใช้หุ่นยนต์ดูดฝุ่นโดยไม่มีไส้กรอง
- อย่าสัมผัสแปรงลูกกลิ้งเมื่อเปิดใช้งานหุ่นยนต์ทำความสะอาด โดยที่แปรงลูกกลิ้งหมุนอยู่ อย่าสัมผัสล้อขณะที่หุ่นยนต์กำลังทำงาน

การใช้งานหุ่นยนต์ดูดฝุ่นในลักษณะที่ขัดกับคำแนะนำข้างต้น อาจทำให้เกิดการบาดเจ็บรุนแรงแก่บุคคลหรือทำให้เกิดผลิตภัณฑ์เสียหายได้ ซึ่งความเสียหายในลักษณะนี้ไม่ได้ครอบคลุมอยู่ในการรับประกันหรือโดยอีเลคโตรลักซ์

การรับประกันไม่ได้ครอบคลุมถึงระยะเวลาการใช้งานแบตเตอรี่ที่ลดลง อันเนื่องมาจากอายุการใช้งานหรือลักษณะการใช้งาน ทั้งนี้เพราะอายุการใช้งานแบตเตอรี่จะขึ้นอยู่กับระยะเวลาและจำนวนครั้งที่ใช้งานหุ่นยนต์ดูดฝุ่น

ก่อนเริ่มทำความสะอาด ให้เก็บสิ่งของชิ้นเล็กๆ และเสียหายง่าย เช่น ผ้า สายรวมผ้ามาน กระดาษและสายไฟออกจากพื้น หากหุ่นยนต์เคลื่อนผ่านและลากสายไฟไปด้วย อาจทำให้เครื่องใช้ไฟฟ้านั้นถูกลากลงจากโต๊ะหรือชั้นวางของได้

หุ่นยนต์ดูดฝุ่นนี้ไม่ได้ออกแบบมาสำหรับการเคลื่อนย้ายสิ่งของขนาดใหญ่ที่อยู่ขวางทาง สิ่งของบางอย่าง เช่น แก้ว ไม้จำเป็นต้องเก็บออกไป เพราะหุ่นยนต์สามารถทำความสะอาดบริเวณรอบๆ ได้

แสงไฟจ้า ผนังกระจก หน้าต่างที่ยาวจากพื้นถึงเพดาน และวัตถุที่สะท้อนแสงได้ดี อาจรบกวนระบบประมวลผลข้อมูลภาพแบบ 3 มิติ

### ไปที่เว็บไซต์ของเราเพื่อ:



รับคำแนะนำที่เป็นประโยชน์ และโบรชัวร์ สอบถามผู้เชี่ยวชาญด้านการแก้ปัญหา ข้อมูลด้านบริการ: [www.electrolux.com](http://www.electrolux.com)



ลงทะเบียนผลิตภัณฑ์เพื่อรับบริการที่ดียิ่งขึ้น: [www.electrolux.com/productregistration](http://www.electrolux.com/productregistration)



ซื้ออุปกรณ์เสริมและวัสดุสิ้นเปลืองสำหรับ หุ่นยนต์ดูดฝุ่นของคุณ: [www.electrolux.com/shop](http://www.electrolux.com/shop)

## คำแนะนำในการใช้งาน การชาร์จและสภาพแวดล้อมในการเก็บรักษาผลิตภัณฑ์แบตเตอรี่อิเล็กทรอนิกส์

### 1. การใช้งาน การชาร์จ และสภาพแวดล้อมในการจัดเก็บ

ผลิตภัณฑ์นี้ออกแบบมาเพื่อใช้งานภายในครัวเรือนในสภาวะปกติเท่านั้น จึงไม่ควรเก็บในที่ที่มีอุณหภูมิสูงหรือต่ำผิดปกติ

เพื่อป้องกันชิ้นส่วนภายในเครื่อง ไม่ควรเก็บ ชาร์จ หรือใช้งานในลักษณะต่อไปนี้

- อุณหภูมิโดยรอบต่ำกว่า 10 °C หรือสูงกว่า 30 °C
- หากเก็บผลิตภัณฑ์ไว้ในที่ที่มีอุณหภูมิต่ำกว่า 10 °C หรือสูงกว่า 30 °C โปรดรอประมาณสองถึงสามชั่วโมง เพื่อให้ชิ้นส่วนภายในผลิตภัณฑ์เย็นลงหรืออุ่นขึ้นและแห้งสนิท ก่อนใช้งาน การใช้งานและการจัดเก็บผลิตภัณฑ์ไว้นอกช่วงอุณหภูมิที่แนะนำอาจทำให้ผลิตภัณฑ์เสียหาย หรือมีอายุการใช้งานสั้นลง
- ระดับความชื้นต่ำกว่า 20% หรือสูงกว่า 80% (ในภาวะที่ไม่มีมีการควบแน่น)

ชาร์จผลิตภัณฑ์เป็นเวลาอย่างน้อย 24 ชั่วโมง

- ก่อนใช้งานครั้งแรก
- เมื่อไม่ใช้งานผลิตภัณฑ์เป็นเวลานาน (ถอดแบตเตอรี่ออกจากหุ่นยนต์เมื่อไม่ใช้งานเป็นเวลานาน)
- หลังจากไม่ได้ใช้งานผลิตภัณฑ์เป็นเวลานาน

### 2. คำเตือนเกี่ยวกับการควบแน่นเป็นหยดน้ำ

การควบแน่นเป็นหยดน้ำอาจเกิดขึ้นภายในผลิตภัณฑ์ภายใต้สภาวะดังต่อไปนี้

- เมื่อนำอุปกรณ์ออกมาจากที่ที่มีอุณหภูมิต่ำ มาอยู่ในที่ที่มีอุณหภูมิสูง
- เมื่ออยู่ในสภาพแวดล้อมที่มีความชื้นสูงมาก
- เมื่อมีการทำความร้อนในห้องที่มีอุณหภูมิต่ำ

โปรดรอประมาณสองถึงสามชั่วโมง เพื่อให้ชิ้นส่วนภายในผลิตภัณฑ์อุ่นขึ้นและแห้งสนิท ก่อนใช้งาน

### 3. เพื่อยืดอายุการใช้งานและประสิทธิภาพของแบตเตอรี่

- ชาร์จแบตเตอรี่อยู่เสมอเมื่อไม่ได้ใช้งาน
- ชาร์จแบตเตอรี่ทันทีที่ได้หลังจากทำความสะอาดเสร็จเรียบร้อยแล้ว หากปล่อยทิ้งไว้นานเกินไปอาจส่งผลต่อการทำงานของแบตเตอรี่

## ข้อควรใส่ใจด้านสิ่งแวดล้อม



สัญลักษณ์ที่ตัวผลิตภัณฑ์นี้บ่งชี้ว่า ผลิตภัณฑ์นี้มีแบตเตอรี่ชนิดชาร์จซ้ำได้ติดตั้งมาพร้อมตัวเครื่อง ซึ่งอาจไม่สามารถกำจัดทิ้งร่วมกับขยะในครัวเรือนตามปกติได้



สัญลักษณ์ที่ตัวผลิตภัณฑ์หรือบรรจุภัณฑ์นี้บ่งชี้ว่าผลิตภัณฑ์นี้อาจไม่สามารถบำบัดแบบเดียวกับขยะในครัวเรือนได้

หากต้องการรีไซเคิลผลิตภัณฑ์ โปรดนำผลิตภัณฑ์ไปส่งที่สถานที่รับคัดแยกขยะที่เป็นทางการ หรือศูนย์บริการอิเล็กทรอนิกส์ที่สามารถถอดและนำแบตเตอรี่รวมถึงชิ้นส่วนอิเล็กทรอนิกส์ไปรีไซเคิลได้อย่างปลอดภัยและเป็นมืออาชีพ ปฏิบัติตามหลักเกณฑ์ในการแยกเก็บอุปกรณ์ไฟฟ้าและแบตเตอรี่ชนิดชาร์จซ้ำที่กำหนดในประเทศของคุณ

## การดูแลและบริการลูกค้า

เมื่อติดต่อศูนย์บริการลูกค้า Electrolux ตรวจสอบให้แน่ใจว่าคุณมีข้อมูลต่อไปนี้พร้อมแล้ว:

- หมายเลขรุ่น
- หมายเลข PNC
- หมายเลขผลิตภัณฑ์

สามารถดูข้อมูลเหล่านี้ได้ที่แผ่นป้ายระบุค่าพิกัด

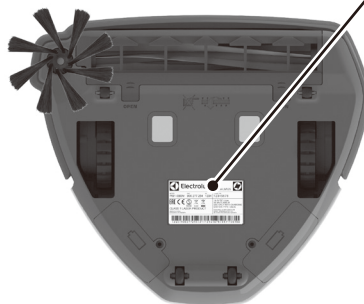

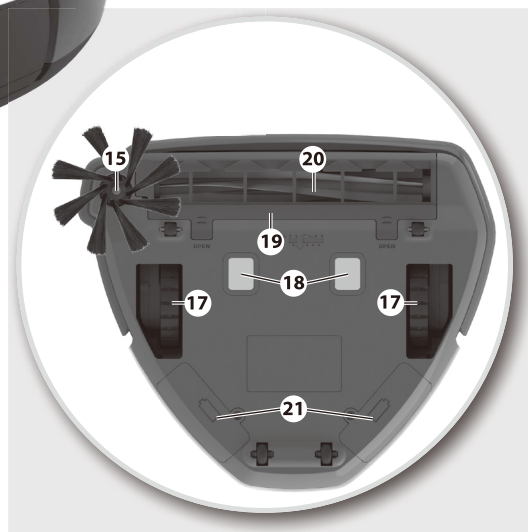
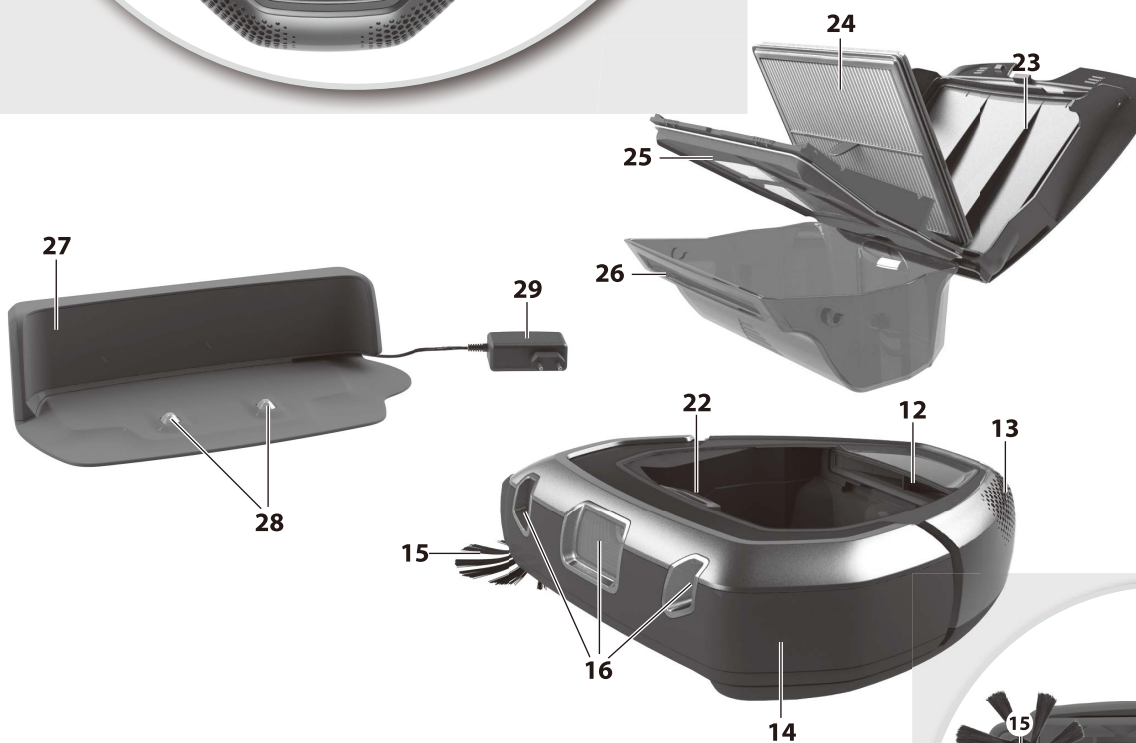
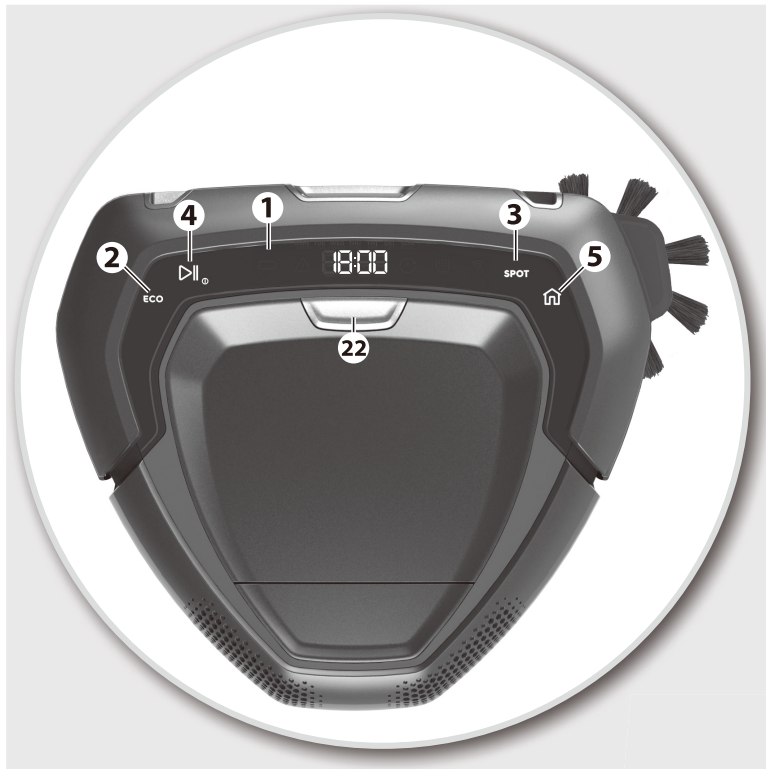

한국어

시작하기 전에

- Electrolux PUREi9 로봇 진공 청소기의 포장을 풀고 모든 액세서리가 들어 있는지 확인하십시오.\*
- 사용 설명서를 주의깊게 정독하십시오.
- 안전 주의 사항 장에 특별한 주의를 기울이십시오.

제품을 처음 사용하시는 경우, “PUREi9” 앱을 다운로드하고 소프트웨어를 업데이트할 것을 권장합니다.

Electrolux PUREi9 로봇 진공 청소기 사용을 즐겨보세요!

목차:

안전 주의 사항 ..... 34

소비자 정보 및 지속가능성 정책 ..... 34

로봇 사용 방법 ..... 40

“PUREi9” 앱 연결 방법 ..... 41

최상의 청소결과를 얻기 위한 팁 ..... 43

먼지통 비우기 ..... 45

필터 청소/교체 ..... 45

세척 및 관리 ..... 46

배터리 교체 ..... 47

오류 처리 ..... 47

문제해결 ..... 48

로봇 진공 청소기 설명

- 1 디스플레이/제어판
- 2 ECO 기능 버튼
- 3 집중 청소 버튼
- 4 시작/정지 버튼/꺼짐 버튼(길게 누름)
- 5 홈 버튼
- 6 시계
- 7 먼지통 표시
- 8 WIFI 연결 표시
- 9 예약 청소 표시
- 10 경고 표시
- 11 배터리 상태 표시
- 12 팬 장치
- 13 배기구
- 14 범퍼
- 15 사이드브러쉬
- 16 3D 비전 시스템(카메라)
- 17 메인 휠
- 18 충전 커넥터
- 19 브러쉬 롤 덮개
- 20 브러쉬 롤
- 21 배터리 칸
- 22 먼지통 분리 버튼
- 23 먼지통 덮개
- 24 필터
- 25 필터 프레임(및 그물망)
- 26 먼지통
- 27 충전대
- 28 충전 커넥터
- 29 전원 어댑터 및 코드

\* 모델별로 액세서리가 달라질 수 있습니다.

ภาษาไทย

ก่อนเริ่มใช้งาน

- แกะหุ้มย่นต์ดูดฝุ่นอิเล็กทรอนิกส์รุ่น PUREi9 ออกจากบรรจุภัณฑ์ และตรวจสอบอุปกรณ์เสริมที่ให้มาว่าครบหรือไม่\*
- อ่านคู่มือการใช้งานอย่างละเอียด
- อ่านคำแนะนำเพื่อความปลอดภัยเป็นพิเศษ

เราขอแนะนำให้คุณดาวน์โหลดแอปพลิเคชัน “PUREi9” และอัปเดตซอฟต์แวร์ก่อนใช้งานครั้งแรก

ขอให้ผลิตเพลนกับการใช้งานหุ่นยนต์ดูดฝุ่นอิเล็กทรอนิกส์รุ่น PUREi9

สารบัญ

ข้อควรระวังเพื่อความปลอดภัย ..... 36

ข้อมูลสำหรับผู้บริโภคและนโยบายด้านความยั่งยืน ..... 36

วิธีใช้หุ่นยนต์ดูดฝุ่น ..... 40

วิธีเชื่อมต่อแอป “PUREi9” ..... 41

เคล็ดลับการใช้งานเพื่อผลลัพธ์สูงสุด ..... 43

การเทฝุ่นในกล่องเก็บฝุ่น ..... 45

การทำความสะอาด/เปลี่ยนไส้กรอง ..... 45

การทำความสะอาดและการบำรุงรักษา ..... 46

การเปลี่ยนแบตเตอรี่ ..... 47

การจัดการข้อผิดพลาด ..... 47

การแก้ไขปัญหาเบื้องต้น ..... 49

คำอธิบายส่วนประกอบของหุ่นยนต์ดูดฝุ่น

- 1 จอแสดงผล / แผงควบคุม
- 2 ปุ่มฟังก์ชันประหยัดพลังงาน
- 3 ปุ่มทำความสะอาดเฉพาะจุด
- 4 ปุ่มเล่น/หยุดชั่วคราว/ปุ่มปิด (กดค้าง)
- 5 ปุ่มโฮม
- 6 นาฬิกา
- 7 ตัวออกสถานะกล่องเก็บฝุ่น
- 8 ตัวออกสถานะการเชื่อมต่อ WIFI
- 9 ตัวออกสถานะการตั้งเวลา
- 10 ตัวออกสถานะการเตือน
- 11 ตัวออกสถานะแบตเตอรี่
- 12 พัดลม
- 13 ช่องระบายอากาศ
- 14 กันชน
- 15 แปรงบิดด้านข้าง
- 16 ระบบประมวลผลข้อมูลภาพแบบ 3 มิติ (กล้อง)
- 17 ล้อหลัก
- 18 ตัวเชื่อมต่อสำหรับชาร์จ
- 19 ฝาครอบแปรงลูกกลิ้ง
- 20 แปรงลูกกลิ้ง
- 21 ช่องใส่แบตเตอรี่
- 22 ปุ่มถอดกล่องเก็บฝุ่น
- 23 ฝาครอบกล่องเก็บฝุ่น
- 24 ไส้กรอง
- 25 แผงไส้กรอง (และตาข่าย)
- 26 กล่องเก็บฝุ่น
- 27 แท่นชาร์จ
- 28 ตัวเชื่อมต่อสำหรับชาร์จ
- 29 อะแดปเตอร์แปลงไฟและสาย

\* อุปกรณ์เสริมอาจแตกต่างกันในแต่ละรุ่น

GB  
CS

CT  
ID

KO  
TH

VI

**로봇 진공 청소기 설치**  
**การติดตั้งหุ่นยนต์ดูดฝุ่น**

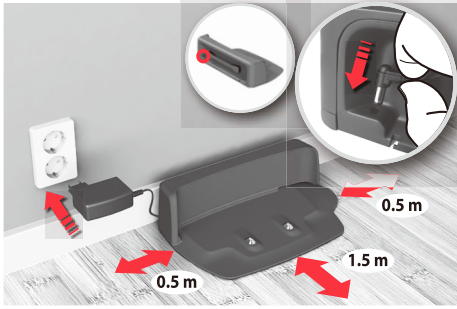

1. 충전대의 후면이 벽을 향하도록 하여 충전대를 바닥에 놓아 주십시오. 어댑터를 충전대 후면의 전원 잭에 꽂아 주십시오. 전원 코드를 연결하여 주십시오. 충전대 후면에 여분의 코드를 감아 두십시오. 충전대의 측면에 0.5m, 앞쪽에 1.5m의 여유 공간을 남겨 두십시오.  
WiFi 모델: 충전대를 WiFi가 잡히는 범위 안에 놓아 두십시오.

1. วางแท่นชาร์จบนพื้นติดกับผนัง เลียบอะแดปเตอร์เข้ากับช่องเสียบสายไฟตรงด้านข้างแท่นชาร์จ เลียบปลั๊กเข้ากับเต้ารับ ม้วนเก็บสายไฟที่อยู่หลังของแท่นชาร์จ ตรวจสอบให้แน่ใจว่า ได้เว้นระยะห่างตรงด้านข้างของแท่นชาร์จ 0.5 เมตร และด้านหน้า 1.5 เมตร รุ่นที่เชื่อมต่อ WiFi: วางแท่นชาร์จให้อยู่ในระยะสัญญาณของเราเตอร์ WiFi



2. 사이드 브러시를 장착하십시오.  
참고: 바닥 전체에 걸쳐 카펫이 깔려있는 방을 청소하는 경우에는 사이드 브러시를 제거하고 사용하셔야 최상의 청소 결과를 얻을 수 있습니다.

2. ใส่แปรงปิดด้านข้าง  
หมายเหตุ: หากใช้หุ่นยนต์ดูดฝุ่นเพื่อทำความสะอาดห้องที่ปูพรมทั้งห้อง ให้นำแปรงปิดด้านข้างออกเพื่อให้ได้ผลการทำความสะอาดที่ดีที่สุด



3. 충전대에 로봇을 놓으십시오.  
배터리 아이콘이 깜빡이며 충전중임을 표시해 줍니다.

3. วางหุ่นยนต์ลงบนแท่นชาร์จ  
ไอคอนแบตเตอรี่จะกะพริบเป็นจังหวะ เพื่อแสดงว่าหุ่นยนต์กำลังชาร์จอยู่

**배터리/충전 상태**  
**สถานะแบตเตอรี่/การชาร์จ**

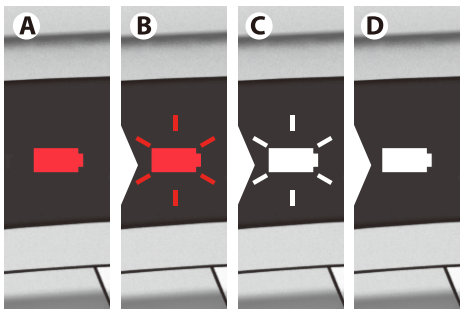

빨간색 배터리 (A) 는 로봇을 충전해야 함을 나타냅니다.  
빨간불 깜빡임 (B) 로봇 충전 중 - 충전 레벨 낮음.  
흰색불 깜빡임 (C):로봇을 사용해도 좋을 정도로 충전되었습니다. (청소하려면 시작/정지 버튼을 누르십시오.)  
흰색불 (D):로봇을 사용할 준비가 되었습니다.  
완전 충전 소요 시간은 약 3시간입니다.

1. แบตเตอรี่เป็นสีแดง (A) แสดงว่าหุ่นยนต์ต้องได้รับการชาร์จไฟ  
ไฟสีแดงกะพริบเป็นจังหวะ (B): หุ่นยนต์กำลังชาร์จอยู่ ปริมาณการชาร์จอยู่ในระดับต่ำ  
ไฟสีขาวกะพริบเป็นจังหวะ (C): หุ่นยนต์มีกำลังไฟเพียงพอสำหรับใช้งาน (กดปุ่มเล่น/หยุดชั่วคราวเพื่อทำความสะอาด)  
ไฟสีขาว (D): หุ่นยนต์พร้อมใช้งาน ระยะเวลาที่ใช้ในการชาร์จไฟจนเต็มประมาณ 3 ชั่วโมง



2. 배터리 수명 및 성능유지:  
- 사용하지 않을 때는 로봇을 항상 충전 상태에 있도록 하십시오.  
- 청소 완료 후에는 최대한 빨리 충전대에서 충전하십시오. 시간이 너무 지나면 배터리에 영향을 줄 수 있습니다.

2. เพื่อยืดอายุการใช้งานและประสิทธิภาพของแบตเตอรี่  
- ชาร์จแบตเตอรี่อยู่เสมอเมื่อไม่ได้ใช้งาน  
- ชาร์จแบตเตอรี่ทันทีที่ทำได้หลังจากทำความสะอาดเสร็จเรียบร้อยแล้ว หากปล่อยให้ไว้นานเกินไป อาจส่งผลต่อการทำงานของแบตเตอรี่

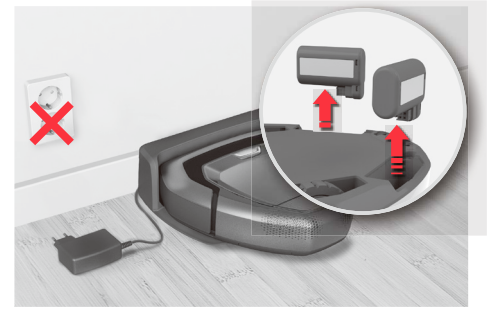

3. 보관(충전하고 있지 않음): 충전하지 않는 상태로 로봇을 장기간 보관해 둘 경우 배터리를 분리해 별도로 보관하십시오. (배터리를 분리하기 전에 먼저 충전하십시오.) 배터리를 분리하려면 47 페이지의 설명을 참조하십시오.

3. การจัดเก็บ (ถอดปลั๊ก): ในกรณีที่เก็บหุ่นยนต์โดยไม่ได้ชาร์จเป็นเวลานาน ให้ถอดแบตเตอรี่ออกจากเครื่องและเก็บแยกต่างหาก (ชาร์จแบตเตอรี่ก่อนถอดออกจากตัวเครื่อง)  
ดูคำแนะนำในการถอดแบตเตอรี่ในหน้า 47.

“PUREi9” แอป 연결 방법  
วิธีเชื่อมต่อแอป “PUREi9”



1. 앱 스토어나 구글 플레이에서 “PUREi9” 앱을 다운로드한 뒤 지침에 따라 계정을 만들어 로봇에 연결하십시오. **참고:** 스마트폰이 홈 와이파이와 연결되었는지 확인하십시오. 로봇을 연결하는 과정에서 와이파이 비밀번호를 입력하게 되어 있습니다. 만약 설정이 안되어있으시다면, 보안을 위해 홈 와이파이 비밀번호를 설정하신 후 로봇 연결을 진행해 주십시오.
1. ดาวน์โหลดแอป “PUREi9” ใน App Store หรือ Google Play แล้วทำตามขั้นตอนเพื่อสร้างบัญชีและเชื่อมต่อกับหุ่นยนต์ **หมายเหตุ:** ตรวจสอบให้แน่ใจว่าเชื่อมต่อโทรศัพท์กับ WiFi ภายในบ้านแล้ว (2.4 GHz)

제품을 처음 사용하시는 경우, “PUREi9” 앱을 다운로드하고 소프트웨어를 업데이트할 것을 권장합니다.  
เราขอแนะนำให้คุณดาวน์โหลดแอปและอัปเดตซอฟต์แวร์ก่อนใช้งานครั้งแรก

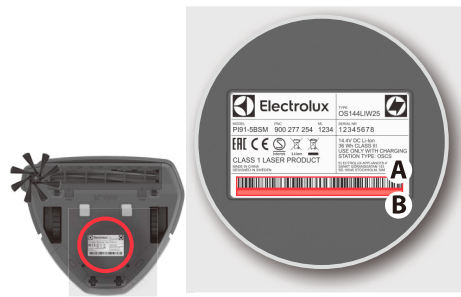

2. 연결하는 과정 중 앱이 로봇을 뒤집어 WiFi 모듈을 활성화하고 일련 번호 바코드 (A) 를 스캔하거나 직접 입력 (B) 하라고 요구할 것입니다. 그러면 앱의 지시에 계속 따르십시오. **참고:** 로봇을 뒤집기 전에 최소 일본 이상 로봇을 켜 둔 상태여야 합니다.
2. ระหว่างการเชื่อมต่อ แอปจะขอให้คุณหงายหุ่นยนต์ทำความสะอาดขึ้นเพื่อเปิดใช้งานโมดูล WiFi และสแกนบาร์โค้ดหมายเลขผลิตภัณฑ์ (A) หรือใส่หมายเลขด้วยตัวเอง (B) จากนั้นทำตามขั้นตอนในแอป **หมายเหตุ:** ก่อนหงายหุ่นยนต์ขึ้น ตรวจสอบให้แน่ใจว่าได้เปิดสวิตช์เป็นเวลาอย่างน้อยหนึ่งนาที



3. 설정이 완료되면 로봇을 정상 위치로 돌려 놓으십시오. 로봇이 홈 네트워크에 연결되었음을 알리는 WiFi 기호 (A) 가 켜집니다. **참고:** 로봇의 시계가 모바일 기기와 자동으로 동기화되기까지 잠깐 시간이 걸릴 수 있습니다. **참고:** WiFi 기호가 깜박이는 것은 로봇이 네트워크 연결을 시도 중임을 알리는 것입니다.
3. เมื่อตั้งค่าเสร็จแล้ว ให้คว่ำหุ่นยนต์ลงมาอยู่ในตำแหน่งปกติ ฟ้าสัญญาณ WiFi (A) จะปรากฏขึ้นเพื่อแสดงว่าหุ่นยนต์เชื่อมต่อกับเครือข่าย WiFi ภายในบ้านแล้ว **หมายเหตุ:** การเชื่อมต่อข้อมูลโดยอัตโนมัติระหว่างหุ่นยนต์กับโทรศัพท์มือถือของคุณอาจใช้เวลาสักครู่ **หมายเหตุ:** สัญญาณ WiFi ที่กะพริบแสดงว่าหุ่นยนต์กำลังพยายามเชื่อมต่อกับเครือข่าย

청소 예약  
การกำหนดเวลาทำความสะอาด



앱에서 청소를 예약할 수 있습니다(날짜 및 시간).

คุณสามารถกำหนดเวลาทำความสะอาดได้จากแอป (วันและเวลา)

청소 모드  
โหมดการทำทำความสะอาด

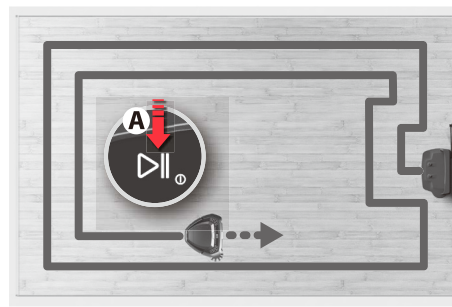

1. 청소를 시작하려면 시작/정지 버튼 (A) 을 누르십시오. 가동된 뒤 몇 초 후 청소가 시작됩니다. 로봇이 벽면을 따라 청소를 시작해 밖에서 안쪽으로 작업을 진행합니다. **참고:** 청소를 정지하려면 “시작/정지” (A) 를 짧게 누르고 청소를 마치려면 길게 누르십시오.

1. กดปุ่มเล่น/หยุดชั่วคราว (A) เพื่อเริ่มทำความสะอาด การทำความสะอาดจะเริ่มขึ้นภายในไม่กี่วินาทีเมื่อเริ่มส่งการ หุ่นยนต์จะเริ่มทำความสะอาดไปตามแนวกำแพงโดยจะเคลื่อนที่ไปทางด้านในห้อง **หมายเหตุ:** กดปุ่ม “เล่น/หยุดชั่วคราว” (A) สั้นๆ เพื่อหยุดทำความสะอาดชั่วคราว หรือกดค้างไว้เพื่อเลิกทำความสะอาด

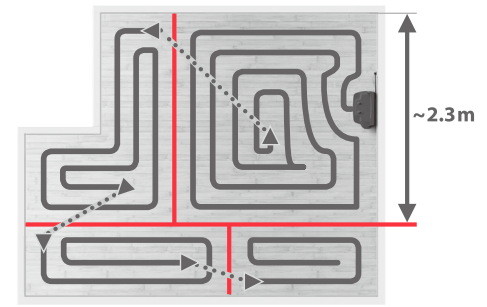

2. 큰 방은 최대 2 x 2.3 m의 공간들로 분할됩니다. **참고:** 청소 패턴은 로봇이 벽쪽부터 청소를 시작할 경우 보다 효율적입니다.

2. ห้องขนาดใหญ่จะแบ่งโซนทำความสะอาดออกเป็นส่วนๆ โดยมีขนาดพื้นที่สูงสุด 2 x 2.3 ม. **หมายเหตุ:** ทิศทางการทำความสะอาดจะให้ผลลัพธ์ที่มีประสิทธิภาพมากยิ่งขึ้น หากหุ่นยนต์เคลื่อนไปตามแนวผนัง

GB  
CS

CT  
ID

KO  
TH

VI

**자동 도킹/충전**

การเชื่อมต่อ/การชาร์จอัตโนมัติ

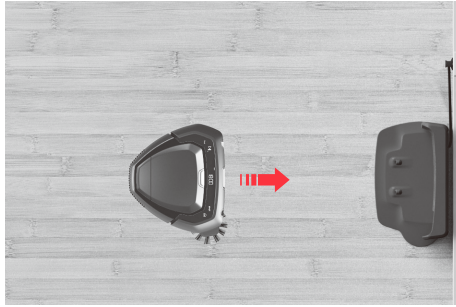

청소가 완료되면 로봇이 자동으로 충전대로 복귀합니다.  
참고: 로봇의 출발 위치가 충전대가 아니면 청소를 마친 후 출발 위치로 돌아옵니다.

เมื่อทำความสะอาดเสร็จแล้ว หุ่นยนต์จะกลับไปที่แท่นชาร์จโดยอัตโนมัติ  
หมายเหตุ: หากจุดตั้งต้นของหุ่นยนต์ไม่ใช่แท่นชาร์จ เมื่อทำความสะอาดเสร็จหุ่นยนต์จะกลับไปจุดตั้งต้นนั้น

**청소 중 자동 충전**

การชาร์จอัตโนมัติระหว่างการทำความสะอาด

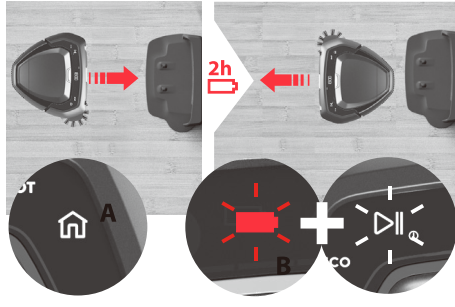

청소 중 충전이 필요하면 홈 버튼이 켜지고 로봇이 충전대로 복귀합니다. 홈 버튼 (A)이 켜집니다. 배터리 및 시작/정지 버튼 (B)이 깜박여 로봇이 충전 중임을 나타내고 멈추었던 곳부터 청소를 재개합니다. 청소를 더 빨리 재개하기 위해 로봇은 최대 90%까지 충전합니다. 충전 소요 시간은 약 2 시간입니다.

หากจำเป็นต้องชาร์จไฟขณะทำความสะอาด ปุ่มโฮมจะสว่างขึ้นและหุ่นยนต์จะกลับไปที่แท่นชาร์จ ปุ่มโฮม (A) ติดสว่าง แบตเตอรี่และเล่น/หยุดชั่วคราว (B) จะสว่างขึ้นเพื่อป้องกันว่าหุ่นยนต์กำลังชาร์จอยู่ และจะกลับไปทำงานต่อตรงจุดที่ทำค้างไว้ หุ่นยนต์จะชาร์จไฟให้ได้ระดับ 90% ของความจุเพื่อกลับมาทำความสะอาดให้เร็วขึ้น ใช้เวลาประมาณ 2 ชั่วโมงในการชาร์จไฟ

**장애물 넘기**

การข้ามธรณีประตู

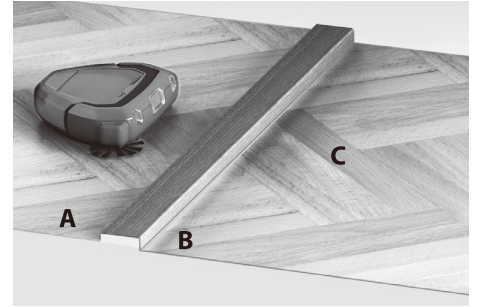

턱을 가로지르거나 장애물을 넘기 전에 로봇은 동작을 멈추고 다음 사항을 점검합니다.  
- 턱/장애물 양쪽의 높이(A 및 B)  
- 반대편 영역에 장애물이 없어 작동할 수 있음 (C)

ก่อนจะข้ามธรณีประตูหรือปีนข้ามสิ่งกีดขวาง หุ่นยนต์จะหยุดเคลื่อนที่เพื่อประเมินดังต่อไปนี้  
- ความสูง (A & B) ทั้งสองด้านของธรณีประตู/สิ่งกีดขวาง  
- ดูว่าพื้นที่อีกด้านหนึ่งเปิดโล่งพอที่จะทำความสะอาดหรือไม่ (C)

**에코 모드**

โหมดประหยัดพลังงาน



'- 에코 모드: 가벼운 청소를 하려면 ECO 버튼을 눌러 전력은 줄이고 가동 시간은 연장하며 청소 소음은 낮춰줍니다. 버튼을 다시 누르기 전까지 로봇은 에코 모드로 동작합니다.

โหมดประหยัดพลังงาน: กดปุ่ม ECO เพื่อลดการใช้พลังงาน ยืดระยะเวลาการใช้งานและลดระดับเสียงสำหรับการทำความสะอาดเพียงเล็กน้อย หุ่นยนต์จะยังคงอยู่ในโหมดประหยัดพลังงาน ต่อไปจนกว่าจะกดปุ่มอีกครั้ง

**도킹**

การเชื่อมต่อ



청소를 중지한 뒤 로봇을 충전대로 복귀시킵니다. 홈 버튼을 누르십시오. 로봇이 출발한 위치가 충전대가 아니면 출발 위치로 돌아옵니다.

หยุดทำความสะอาดและนำหุ่นยนต์กลับไปที่แท่นชาร์จ กดปุ่มโฮม หากจุดตั้งต้นของหุ่นยนต์ไม่ใช่แท่นชาร์จ เมื่อทำความสะอาดเสร็จหุ่นยนต์จะกลับไปจุดตั้งต้นนั้น

**집중 청소**

ทำความสะอาดเฉพาะจุด



집중 청소(1㎡ 이내의 좁은 영역) 로봇이 청소할 공간을 향하도록 한 뒤 SPOT 버튼을 누르십시오. 로봇이 해당 공간을 두 번 청소합니다.

ทำความสะอาดเฉพาะจุด (พื้นที่แคบประมาณ 1 ตร.ม.): วางหุ่นยนต์ให้หันหน้าไปยังจุดที่ต้องการทำความสะอาด แล้วกดปุ่ม ทำความสะอาดเฉพาะจุด (SPOT) หุ่นยนต์จะทำความสะอาดบริเวณนั้นสองครั้ง

## 청소 공간 준비

### การเตรียมพื้นที่ที่จะทำความสะอาด

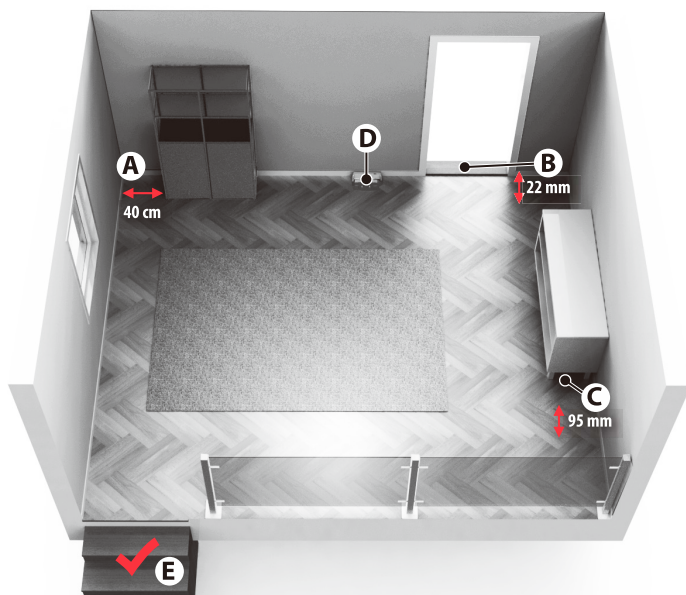

- (A) 가구 주변에 40 cm의 여유 공간을 남겨 두십시오.
- (B) 로봇은 최대 22 mm 높이까지는 턱을 쉽게 넘습니다.
- (C) 가구 밑에 95 mm의 여유공간이 있다면 가구 밑 청소가 가능합니다.
- (D) 문 왼쪽에 충전대를 놓아 두십시오.
- (E) 로봇은 계단 및 급경사를 탐지합니다.

- (A) เว้นระยะห่างระหว่างเฟอร์นิเจอร์ที่ไม่มีขาตั้งกับผนังอย่างน้อย 40 ซม.
- (B) หุ่นยนต์สามารถข้ามธรณีประตูที่มีความสูงไม่เกิน 22 มม. ได้อย่างง่ายดาย
- (C) หุ่นยนต์สามารถทำความสะอาดบริเวณใต้เฟอร์นิเจอร์ที่สูงจากพื้น 95 มม.
- (D) วางแท่นชาร์จไว้ทางซ้ายของประตู
- (E) หุ่นยนต์จะตรวจหาขั้นบันไดและพื้นต่างระดับ

## 청소 공간 준비

청소를 하기 전에 의류, 커튼 끈, 종이 및 바닥의 전원 코드와 같이 작고 약한 물체는 치우십시오. 로봇이 전원 코드 위로 지나면서 전원 코드를 끌어 당길 경우 탁자나 선반 위의 물체가 떨어질 위험이 있습니다.

의자와 같이 크고 키 큰 물체는 바닥에 그대로 두면 로봇이 빙 돌아가며 청소합니다.

강한 빛, 거울이 부착된 벽, 바닥에서 천정까지 이어져 있는 창 및 아주 밝은 물체는 3D 비전 시스템에 오류를 유발할 수 있습니다.

## 청소 공간 제한

로봇은 닿을 수 있는 모든 바닥을 청소합니다. 청소할 영역을 제한하려면 간단히 문을 닫거나 장애물을 놓아 두십시오.

## 예약 청소 사이의 먼지 비우기

예약 청소를 최대한 활용하려면 정기적으로 먼지통을 비우십시오.

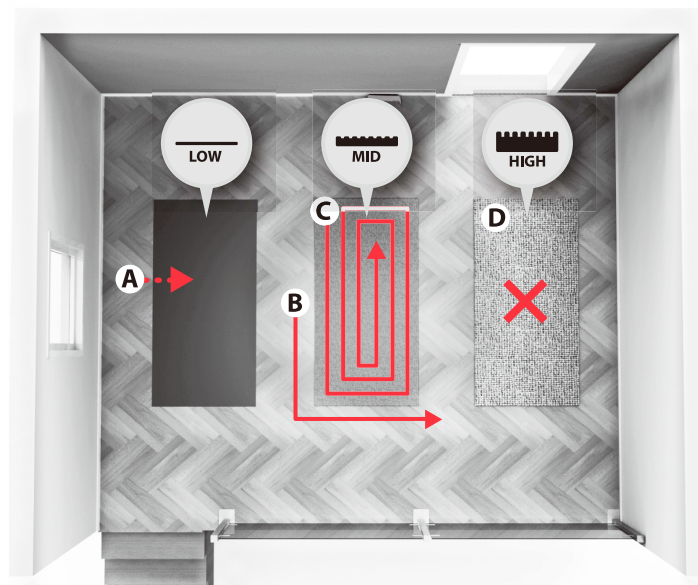

### 카펫: 로봇의 카펫 청소방식

- 짧은 길이의 카펫: (A) 방청소와 같은 패턴으로 청소
- 중간 길이의 카펫: (B) 카펫 주위를 먼저 청소하고 (C) 나중에 돌아와 카펫을 따로 청소
- 길이가 긴 카펫: (D) 카펫위를 청소하지 않음. 로봇이 카펫 가장자리에 도달하면 주위 공간의 청소를 계속 함

### พรม: หุ่นยนต์ทำความสะอาดดังต่อไปนี้

- พรมขนสั้น: (A) ลักษณะเดียวกันกับการทำความสะอาดห้อง
- พรมขนยาวปานกลาง: (B) ทำความสะอาดรอบพรมก่อน (C) แล้วจึงกลับมาทำความสะอาดพรมทีหลัง
- พรมขนยาว: (D) จะไม่ทำความสะอาด เมื่อทำความสะอาดถึงขอบพรม หุ่นยนต์จะทำความสะอาดบริเวณที่เหลือต่อไป

## การเตรียมพื้นที่ที่จะทำความสะอาด

ก่อนเริ่มทำความสะอาด ให้เก็บสิ่งของชิ้นเล็กๆ และเสียบสายง่าย เช่น ผ้า สายรวมผ้าผ่าน กระดาษและสายไฟออกจากพื้น หากหุ่นยนต์เคลื่อนผ่านและลากสายไฟไปด้วย อาจทำให้เครื่องใช้ไฟฟ้านั้นถูกลากลงจากโต๊ะหรือชั้นวางของได้

สิ่งของบางอย่างที่มีขนาดใหญ่กว่า/สูงกว่า เช่น เก้าอี้ ไม่จำเป็นต้องเก็บออกไป เพราะหุ่นยนต์สามารถทำความสะอาดบริเวณรอบๆ ได้

แสงไฟจ้า ผนังกระจก หน้าต่างที่ยาวจากพื้นถึงเพดาน และวัตถุที่สะท้อนแสงได้ดี อาจรบกวนระบบประมวลผลข้อมูลภาพแบบ 3 มิติ

## การจำกัดพื้นที่ที่จะทำความสะอาด

หุ่นยนต์สามารถทำความสะอาดทั่วทั้งพื้นที่ที่สามารถเข้าถึงได้ หากต้องการจำกัดพื้นที่สำหรับทำความสะอาด ให้ปิดประตูหรือวางสิ่งกีดขวางเอาไว้

## การเว้นระยะหว่างการทำความสะอาดตามกำหนดเวลา

เพื่อให้การทำความสะอาดตามกำหนดเวลาได้ผลสูงสุด ให้เทกองเก็บฝุ่นอย่างสม่ำเสมอ



로봇은 항상 정면을 위로 해 두 손으로 옮기십시오.  
직접 로봇 옮기기:  
청소 중에 로봇을 옮기면 처음부터 청소를 다시 시작하므로 이는 바람직하지 않습니다.

ยกหุ่นยนต์ด้วยสองมือเสมอโดยหงายด้านหน้าขึ้น การเคลื่อนย้ายหุ่นยนต์ด้วยตัวเอง:  
ไม่แนะนำให้เคลื่อนย้ายหุ่นยนต์ขณะกำลังทำความสะอาด เนื่องจากหุ่นยนต์อาจต้องเริ่มทำความสะอาดใหม่ตั้งแต่ต้น

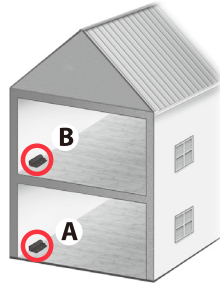

2층 이상 주택을 청소할 경우 각 층별로 별도의 충전대를 사용하면 청소가 쉬워집니다.  
(ANC: 406000071)

การทำความสะอาดบ้านที่มีหลายชั้นสามารถทำได้ง่ายยิ่งขึ้น โดยวางแท่นชาร์จเพิ่มเติมในแต่ละชั้น (ANC: 406000071)

로봇 종료하기 / ปิดระบบการทำงาน Robot

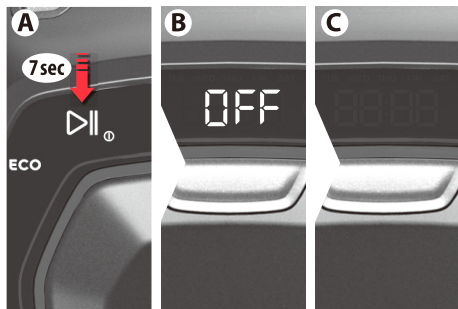

로봇 종료하기: 로봇을 일정시간동안 사용하지 않기 위해 종료 시켜두기를 원하는 경우, 아래와 같이 설정하세요:  
- 시작/정지 (A) 버튼을 약 7초간 누르세요  
- 화면에 OFF표시가 나타납니다 (B)  
- 로봇이 완전히 종료되며, 화면이 꺼집니다. (C).

ปิดระบบการทำงาน Robot: คุณสามารถปิดระบบการทำงาน Robot ให้สมบูรณ์ได้ ในกรณีที่คุณไม่ได้ใช้งานด้วยระยะเวลาที่แน่นอน โดยทำตามขั้นตอนดังต่อไปนี้  
- กดปุ่ม Play (ตามรูป A) บนตัว Robot ค้างไว้ประมาณ 7 วินาที  
- สัญลักษณ์ "OFF" จะแสดงตามบนจอแสดงผล (ตามรูป B)  
- ปิดการทำงาน Robot โดยสมบูรณ์ เมื่อจอแสดงผลดับลง (ตามรูป C)

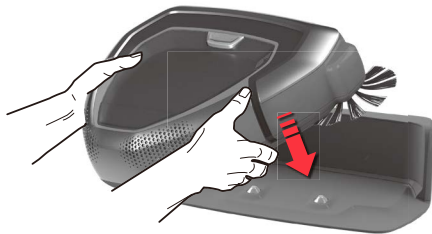

로봇을 다시 시작하려면, 충전대에 다시 놓아주세요. 충전대에 둔 상태에서 종료한 후, 로봇을 다시 시작하려면, 로봇을 위로 들었다가 충전대에 다시 원위치 시켜주세요.

เริ่มต้นระบบการทำงานใหม่โดยการนำ Robot กลับไปวางที่แท่นชาร์ตอีกครั้ง คุณสามารถปิดระบบการทำงาน Robot ได้ ขณะที่วางบนแท่นชาร์ต และคุณต้องยกตัว Robot ขึ้น แล้ว วางลงบนแท่นชาร์ตอีกครั้งเพื่อกลับมาใช้งานใหม่

**먼지통 비우기**  
**การเทฝุ่นในกล่องเก็บฝุ่น**

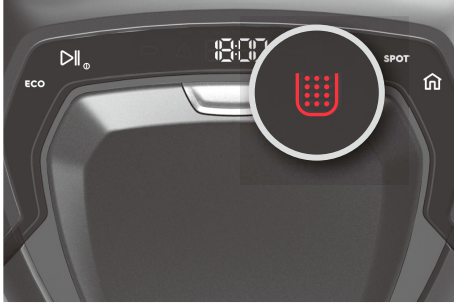

1. 정기적으로 먼지통을 비워주십시오. 먼지통 아이콘이 켜져 있으면 먼지통을 비워 주셔야 합니다.  
 ⚠ 먼지통을 비웠는데도 먼지통 기호가 켜져 있으면 필터를 청소하십시오.

1. หมั่นเทฝุ่นในกล่องเก็บฝุ่นอยู่เสมอ หรือเมื่อมีสัญญาณไฟขึ้นที่ไอคอนกล่องเก็บฝุ่น  
 ⚠ หากสัญญาณไฟที่กล่องเก็บฝุ่นยังสว่างอยู่หลังจากเทฝุ่นไปแล้ว โปรดทำความสะอาดไส้กรอง

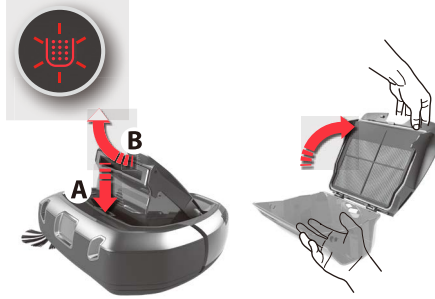

2. 분리 버튼 (A)을 누른 뒤 먼지통을 위로 들어 올려 꺼내십시오(B). 덮개를 위로 당겨 여십시오. 먼지통을 비우십시오.  
 참고: 먼지통이 분리되었거나 위치가 올바르게 않으면 먼지통 아이콘이 깜빡입니다.

2. กดปุ่มถอดกล่องเก็บฝุ่น (A) แล้วนำกล่องออกมาโดยยกขึ้นด้านบน (B) เปิดฝาออกโดยยกขึ้นด้านบน เทฝุ่นลงในถังขยะ  
 หมายเหตุ: ไอคอนกล่องเก็บฝุ่นสว่างขึ้นเพื่อบ่งชี้ว่า กล่องเก็บฝุ่นถูกถอดออก หรือไม่อยู่ในตำแหน่งที่ถูกต้อง



3. 먼지통을 비운 뒤 덮개를 닫고 제 위치에 끼우십시오. 로봇에 먼지통을 재장착하십시오.  
 참고: 먼지통이 올바르게 결합되지 않은 상태로 시작/정지 버튼을 누르면 먼지통 아이콘이 깜빡입니다. 먼지통을 올바르게 다시 장착하십시오.

3. หลังจากเทฝุ่น ให้ปิดฝากล่องแล้วใส่กลับตามเดิม ปรับตำแหน่งกล่องเก็บฝุ่นให้เข้ากับหุ่นยนต์  
 หมายเหตุ: หากใส่กล่องเก็บฝุ่นกลับเข้าที่ไม่ถูกต้อง และกดปุ่มเล่น/หยุดชั่วคราวไปแล้ว ไฟไอคอนกล่องเก็บฝุ่นจะสว่างขึ้น ให้ใส่กล่องเก็บฝุ่นเข้าไปใหม่ให้ถูกต้อง

**필터 청소**  
**การทำความสะอาดไส้กรอง**

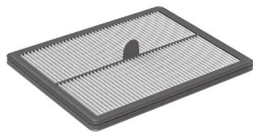

1. 최상의 청소성능을 유지하려면 청소를 5회 할 때마다 필터를 청소하고 6개월 주기로 필터를 교체해 주는 것을 권장합니다.  
 (품번: ERK2)

1. เพื่อประสิทธิภาพสูงสุด เราขอแนะนำให้ทำความสะอาดไส้กรองทุกๆ 5 รอบการทำความสะอาด และเปลี่ยนแผ่นกรองทุก 6 เดือน (Ref: ERK2)

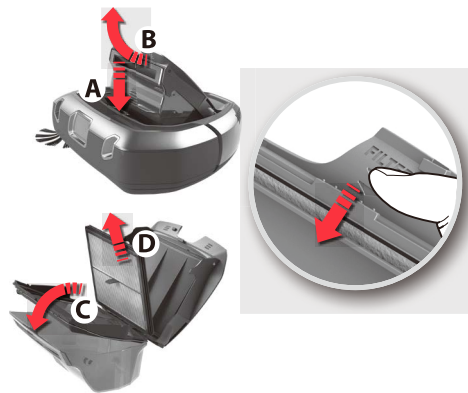

2. 필터를 분리하십시오. 먼지통을 위로 들어 올려 꺼내십시오(B). 덮개를 위로 당겨 여십시오. 필터 프레임은 아래로 내리십시오(C). 필터를 분리하십시오(D).

2. ถอดไส้กรอง: นำกล่องเก็บฝุ่นออกมาโดยยกขึ้นทางด้านบน (B) เปิดฝาออกโดยยกขึ้นด้านบน ดึงแผงไส้กรองออกทางด้านล่าง (C) ถอดไส้กรองออก (D)

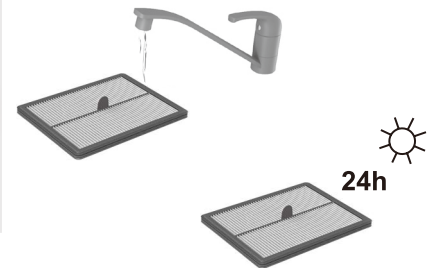

3. 차가운 물로 필터를 행구십시오. 필터 프레임을 두드려 물기를 제거하십시오. 로봇에 장착하기 전에 24시간 동안 건조시키십시오.

3. ล้างไส้กรองกรองด้วยน้ำเย็น สบับน้ำออกจากแผงไส้กรอง นำแผงไส้กรองไปผึ่งไว้เป็นเวลา 24 ชั่วโมงก่อนใส่กลับเข้าไปในเครื่อง

GB  
CS  
  
CT  
ID  
  
KO  
TH  
  
VI

### 3D 비전 시스템 청소

การทำความสะอาดระบบประมวลผลข้อมูลภาพแบบ 3 มิติ (กล้อง)

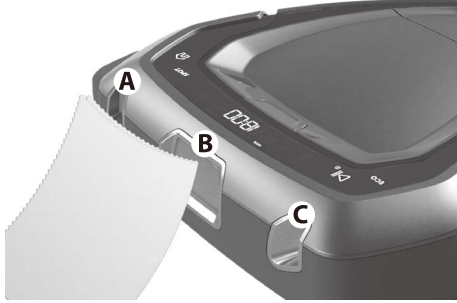

3D 비전 시스템은 창(A,B,C)이 깨끗하고 긁힌 곳이 없을 때 가장 잘 작동합니다. 가벼운 먼지는 부드럽고 마른 헝겊을 사용해 닦으십시오. 심하게 더러워졌으면 연한 세제를 사용해 닦으십시오.

ระบบประมวลผลข้อมูลภาพแบบ 3 มิติ ทำงานได้ผลดีที่สุด เมื่อหน้าต่างแสดงผล (A, B, C) อยู่ในสภาพที่สะอาดและไม่มีรอยขีดข่วน เช็ดคราบฝุ่นที่เกาะออกด้วยผ้าแห้งและนุ่ม หากมีคราบสกปรกติดแน่น ให้ใช้ผงซักฟอกอ่อนๆ เช็ดทำความสะอาด

### 휠 세척

การทำความสะอาดล้อ

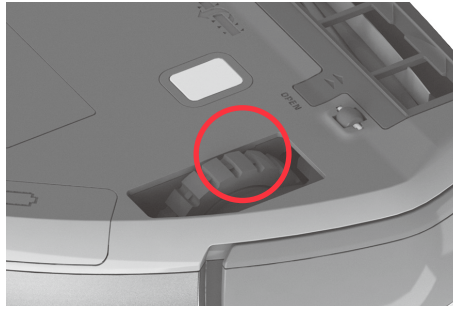

1. 메인 휠이 매끄럽게 회전하도록 메인 휠에 얽혀 있는 머리카락같은 이물질들을 제거해 주십시오.

1. ดึงเส้นผมที่พันกันหรือสิ่งที่มีลักษณะดังกล่าวออกจากล้อหลัก เพื่อให้ล้อหมุนได้อย่างอิสระ

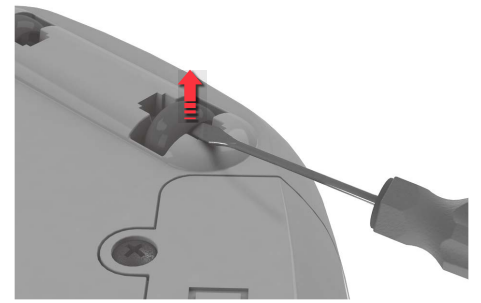

2. 작은 바퀴가 걸렸을 경우에는 작은 드라이버를 사용하여 조심스럽게 분리한 뒤 바퀴를 세척하십시오.

2. หากล้อเล็กหมุนติดขัด ให้ใช้ไขควงขนาดเล็ก ถอดล้อออกอย่างระมัดระวัง แล้วจึงทำความสะอาด

### 사이드 브러쉬 청소

การทำความสะอาดแปรงปิดด้านข้าง

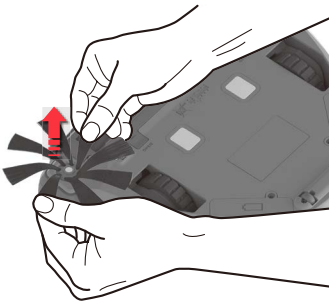

사이드 브러쉬를 당겨 분리하십시오. 사이드 브러쉬를 청소하십시오. 소켓에 사이드 브러쉬를 다시 장착하십시오. 사이드 브러쉬는 교체할 수 있습니다. (품번: ERK2 / EBSB2)

ดึงแปรงปิดด้านข้างออกมา ทำความสะอาดแปรงปิดด้านข้าง ใส่แปรงปิดด้านข้างกลับเข้าไปในเบ้า แปรงปิดด้านข้างสามารถเปลี่ยนได้ (Ref: ERK2 / EBSB2)

### 브러쉬 롤 청소

การทำความสะอาดแปรงลูกกลิ้ง



1. OPEN 표시 윗부분을 누르고 덮개를 앞으로 밀어 브러쉬 롤 덮개를 분리하십시오.

1. กดสลักทั้งสองด้าน แล้วเลื่อนฝาครอบไปข้างหน้าเพื่อถอดออก



2. 브러쉬 롤을 분리하여 꺼낸 후 청소하십시오. 가위로 영킨 가닥들을 잘라 제거하십시오. 역순으로 다시 장착하십시오. 브러쉬 롤은 교체할 수 있습니다. (품번: ERK2)

2. ดึงแปรงลูกกลิ้งออก ทำความสะอาดแปรงและดลบลูกป็น นำเศษด้ายที่พันกันออกโดยใช้กรรไกร ตัดให้ขาดจากกัน ใส่ชิ้นส่วนที่ถอดออกกลับเข้าไปใหม่โดยทำย้อนลำดับ แปรงลูกกลิ้งสามารถเปลี่ยนได้ (Ref: ERK2)

### 공기 흡입구 청소

การทำความสะอาดช่องระบายลม



먼지통을 분리하십시오. 공기 흡입구를 막고 있는 이물질질을 제거하십시오. 먼지통을 제 위치에 끼우십시오.

ถอดกล่องเก็บฝุ่นออก นำเศษขยะที่อุดตันในช่องระบายลมออก ใส่กล่องเก็บฝุ่นกลับเข้าที่

### 충전단자 청소방법

วิธีการทำความสะอาดแผ่นหน้าสัมผัสแท่นชาร์จ



물기가 없는 부드러운 천으로 충전대와 제품 바닥의 충전단자를 정기적으로 청소해주세요.

ทำความสะอาดหน้าสัมผัสแท่นชาร์จ และหน้าสัมผัสใต้หุ่นยนต์ดูดฝุ่น ด้วยผ้าแห้งอย่างสม่ำเสมอ

### 배터리 교체

การเปลี่ยนแบตเตอรี่

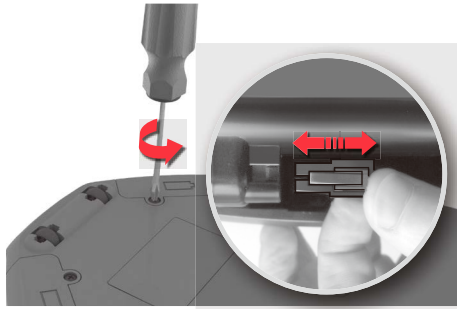

1. 배터리 칸은 로봇 바닥면에 있습니다. 드라이버 (PH2)를 사용해 배터리 칸 덮개를 분리하십시오. 배터리 팩을 교체한 뒤 배터리 칸 덮개를 다시 장착하십시오.  
⚠️ 주의! 배터리 팩 두 개를 동시에 교체하십시오.

1. ช่องใส่แบตเตอรี่อยู่ข้างใต้หุ่นยนต์ ใช้ไขควง (PH2) ชนน็อตตรงฝาครอบช่องใส่แบตเตอรี่ออก เปลี่ยนแบตเตอรี่ชุดใหม่ แล้วใส่ฝาครอบช่องใส่แบตเตอรี่กลับเข้าที่  
⚠️ ข้อควรระวัง! ตรวจสอบให้แน่ใจว่าได้เปลี่ยนชุดแบตเตอรี่พร้อมกันทั้งสองชุด

### 오류 처리

การจัดการข้อผิดพลาด



1. 오류가 발생하면 로봇이 청소를 중지합니다. 경고 아이콘이 깜박이고 “E:” 뒤에 숫자가 붙은 오류 코드가 디스플레이에 표시됩니다. 오류를 설명하는 음성 메시지도 들립니다. 오류가 발생한 뒤 아무 버튼이나 누르면 음성 메시지가 다시 들립니다.

1. หากมีข้อผิดพลาดเกิดขึ้น หุ่นยนต์จะหยุดทำความสะอาด ไอคอนการเตือนจะกะพริบบนหน้าจอ ตามด้วยตัว E และรหัสข้อผิดพลาด โดยลำโพงจะอธิบายข้อผิดพลาดนั้นด้วย หลังจากเกิดข้อผิดพลาด ให้กดปุ่มเพื่อฟังข้อความเสียงอีกครั้ง



2. 공급업체 정품 배터리만 사용하십시오. 로봇을 떼기하기 전에 먼저 배터리를 분리해 안전하게 떼기해야 합니다. (ANC: 405 537 959/0)

2. ใช้เฉพาะแบตเตอรี่ของแท้จากซัพพลายเออร์เท่านั้น ก่อนทิ้งเครื่อง ต้องถอดแบตเตอรี่ออกก่อนและนำไปกำจัดอย่างปลอดภัย (ANC: 405 537 959/0)

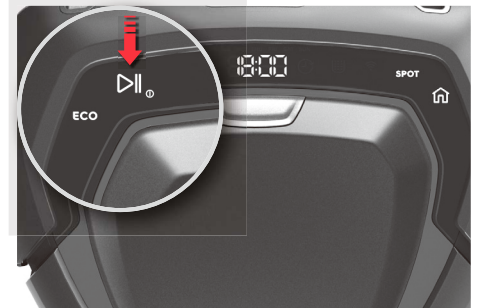

2. 오류가 해결되면 시작/정지 버튼을 눌러 청소를 시작하십시오. 참고: 전체 오류 코드 목록과 해결 방법을 보려면 “문제해결”의 지침을 참조하십시오.

2. เมื่อแก้ไขข้อผิดพลาดแล้ว ให้กดปุ่มเล่น/หยุดชั่วคราวเพื่อเริ่มทำความสะอาด  
หมายเหตุ: หากต้องการดูรายการรหัสข้อผิดพลาดและวิธีแก้ไขทั้งหมด ให้ดูคำแนะนำใน “การแก้ไขปัญหาเบื้องต้น”

문제해결

| 문제                    | 오류 코드 | 원인   | 해결책  |
|-----------------------|-------|--|--|
| 디스플레이가 공백 상태입니다.      | -     | 배터리가 없습니다.                                   | 배터리를 충전하십시오.   |
| 로봇이 작동하지 않습니다.        | (x3)  | 먼지통이 없거나 올바르게 닫히지 않았습니다.                     | 로봇에 먼지통을 장착하고 덮개를 올바르게 닫으십시오.  |
|                       |       | 로봇이 들러 있습니다.                                 | 시작하기 전에 로봇을 바닥에 놓으십시오.   |
| 로봇이 제대로 이동/청소하지 못합니다. | E:10  | 범퍼에 이물질이 있습니다.                               | 범퍼가 원활히 움직일 수 있는지 확인하고 범퍼를 막고 있는 이물질이 있으면 제거하십시오.  |
|                       | E:11  | 오른쪽 바퀴에 이물질이 있습니다.                           | 모든 부품이 부드럽게 회전하는지 확인하십시오.  |
|                       | E:12  | 왼쪽 바퀴에 이물질이 있습니다.                            | 필요한 경우 부품을 청소하고 영킨 가닥들을 제거 하십시오.   |
|                       | E:13  | 브러쉬 롤에 이물질이 있습니다.                            | 브러쉬 롤이나 사이드 브러쉬가 손상되었으면 교체하십시오.  |
|                       | E:14  | 사이드 브러쉬에 이물질이 있습니다.                          | 46 페이지 "세척 및 관리"를 확인하십시오.  |
|                       | E:15  | 로봇이 끼어 있거나 이동할 수 없습니다.                       | 로봇을 들어 자유롭게 움직일 수 있는 장소에 두십시오. 43 페이지의 "최상의 청소결과를 얻기 위한 팁"을 확인하십시오.                          |
|                       | E:16  | 3D 비전 시스템이 막혀 있거나 먼지투성이입니다.                  | 3D 비전 시스템을 청소하고 시야를 가리는 것이 없는지 확인하십시오. 46 페이지 "세척 및 관리"를 확인하십시오.                             |
| 충전 상태가 표시되지 않습니다.     | -     | 먼지통이 가득 찼거나 막혀 있습니다.                         | 먼지통을 비우거나 청소하십시오. 45 페이지 "먼지통 비우기"를 확인하십시오.  |
|                       |       | 로봇이 너무 미끄러운 장소에서 작동하고 있습니다.                  | 로봇과 충전기를 새로운 장소에 놓고 다시 시작하십시오.   |
| 충전 상태가 표시되지 않습니다.     | -     | 전원 코드 및 어댑터가 올바르게 결합되지 않았거나 콘센트에 연결되지 않았습니다. | 충전대에 어댑터 커넥터를 연결하십시오. 콘센트에 전원 케이블을 연결하십시오. 로봇의 충전판과 충전대가 연결되어 있는지 확인하십시오.                    |
|                       |       | 로봇의 충전판과 충전대가 연결되지 않았습니다.                    | 플러그와 케이블이 손상되지 않았는지 점검하십시오.  |
| 배터리가 빠르게 방전됩니다.       | -     | 배터리 수명이 만료되었습니다.                             | 배터리 팩 2개를 교체하십시오. 47 페이지의 "배터리 교체"를 확인하십시오.  |
| 배터리 관련 문제             | E:20  | 잘못된 충전대가 사용되었습니다.                            | 로봇과 함께 제공하는 경품 Electrolux 충전대만 사용하십시오. 충전대를 교체해야 할 경우 Electrolux 충전대(ANC: 40600071)를 사용하십시오. |
|                       | E:21  | 사용 중에 배터리가 오작동합니다.                           | 배터리 팩 2개를 교체하십시오. 47 페이지의 "배터리 교체"를 확인하십시오.  |
|                       | E:22  | 제품이 과열되었습니다.                                 | 충전대로부터 분리하시고 6시간 동안 멈춰 두십시오.   |
|                       | E:23  | 플러그가 로봇에 제대로 연결되지 않았습니다.                     | 로봇에 배터리를 연결하십시오. 47 페이지의 "배터리 교체"를 확인하십시오.   |
| 시간이 표시되지 않습니다.        | --:-- | 현재 시간이 설정되지 않았습니다.                           | 로봇이 WiFi에 연결되면 시간이 자동으로 설정됩니다.   |

| 문제                                | 오류 코드 | 원인                                  | 해결책  |
|-----------------------------------|-------|-------------------------------------|--|
| 로봇에 잘못된 시간이 표시됩니다.                | -     | 로봇이 WiFi 네트워크에서 업데이트된 시간을 받지 못했습니다. | 로봇이 WiFi 네트워크에 연결되어 있는지 확인한 뒤 정확한 시간을 수신할 때까지 대기하십시오. 24시간 이내에 업데이트되지 않으면 온보딩 프로시저를 다시 시작하십시오. |
| 방 청소가 제대로 되지 않았는데 로봇이 충전대로 복귀합니다. | -     | 로봇이 배터리를 충전하기 위해 충전대로 복귀하는 중입니다.    | 배터리가 충전되면 로봇이 즉시 자동으로 청소 프로그램을 계속 수행합니다.   |
| 로봇에 물이 들어갔습니다.                    | -     | -                                   | 모터 교체는 Electrolux 공식 서비스 센터에서 수행해야 합니다. 물이 스며들어 발생한 모터 손상은 보증 서비스를 받을 수 없습니다.                  |
| 소프트웨어 문제                          | E:30  | 소프트웨어가 올바르게 작동하지 않습니다.              | 로봇의 소프트웨어를 업데이트하십시오.   |
|                                   | E:31  | 소프트웨어 업그레이드에 실패했습니다.                | 소프트웨어 업데이트를 다시 수행하십시오.   |
| 경비 필요                             | E:40  | -                                   | Electrolux 공식 서비스 센터에 연락하십시오.  |
| 시스템 오류                            | E:41  | 내부 오류.                              | 원하는 작업을 다시 시작하십시오.   |
|                                   | E:42  | -                                   | -  |

**문제가 계속 발생하면 앱이나 웹사이트의 정비 부분을 참조하십시오.**

소모품 및 액세서리

 [www.electroluxshop.co.kr](http://www.electroluxshop.co.kr)

 PUREi9 Performance 퍼포먼스 키트  
Ref: ERK2  
PNC: 9001677674

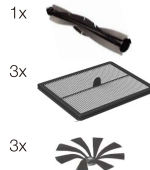

 PUREi9 Power 파워 브러쉬  
REF: EBSB2  
PNC: 9001683938





 충전대  
ANC: 40600071



 배터리 팩  
ANC: 405 537 959/0



การแก้ไขปัญหาเบื้องต้น

| ปัญหา   | รหัสข้อผิดพลาด  | สาเหตุ   | วิธีแก้ไข   |
|---|---|--|---|
| ไม่มีข้อมูลแสดงบนหน้าจอ   | -   | แบตเตอรี่หมด   | ชาร์จแบตเตอรี่  |
| หุ่นยนต์ไม่เริ่มทำงาน   |  | ไม่ได้ใส่กล่องเก็บฝุ่นเข้าไปในหุ่นยนต์หรือไม่ได้ปิดฝาให้สนิท                           | ใส่กล่องเก็บฝุ่นเข้าไปในตัวหุ่นยนต์ แล้วปิดฝาให้สนิท  |
|   |   |  (x3) | หุ่นยนต์ถูกจับยกขึ้น  |
| หุ่นยนต์ไม่เคลื่อนที่/ทำความสะอาดไม่ถูกวิธี   | E:10  | กันชนติดขัด  | โปรดตรวจสอบให้แน่ใจว่า กันชนสามารถเคลื่อนที่ได้โดยเหมาะสมและกีดขวางขยะที่อาจกีดขวางออก  |
|   | E:11  | ล้อด้านขวาติดขัด   | ตรวจสอบว่าชิ้นส่วนทุกชิ้นสามารถหมุนได้อย่างอิสระ ทำความสะอาดและดึงเส้นด้ายที่พันติดตามชิ้นส่วนต่างๆ ออก หากจำเป็น เปลี่ยนแปรงลูกกลิ้งหรือแปรงบิดด้านข้าง หากพบการชำรุดเสียหาย ดูข้อมูล "การทำความสะอาดและการบำรุงรักษา" หน้า 46 |
|   | E:12  | ล้อด้านซ้ายติดขัด  |   |
|   | E:13  | แปรงลูกกลิ้งติดขัด   |   |
|   | E:14  | แปรงบิดด้านข้างติดขัด  |   |
|   | E:15  | หุ่นยนต์เกิดการติดขัดหรือไม่สามารถเคลื่อนไปในทิศทางต่างๆ ได้                           | ยกหุ่นยนต์ขึ้นและวางไว้ในตำแหน่งที่สามารถเคลื่อนที่ได้โดยอิสระ ดูข้อมูล "เคล็ดลับการใช้งานเพื่อผลลัพธ์สูงสุด" หน้า 43   |
|   | E:16  | ระบบประมวลผลข้อมูลภาพแบบ 3 มิติมีบางอย่างบดบังหรือมีฝุ่นเกาะ                           | ทำความสะอาดระบบประมวลผลข้อมูลภาพแบบ 3 มิติและตรวจสอบให้แน่ใจว่าไม่มีสิ่งใดบดบังบริเวณรับภาพ ดูข้อมูล "การทำความสะอาดและการบำรุงรักษา" หน้า 46   |
|  |   | กล่องเก็บฝุ่นเต็มหรืออุดตัน  | เทและ/หรือทำความสะอาดกล่องเก็บฝุ่น ดูข้อมูล "การเทฝุ่นในกล่องเก็บฝุ่น" หน้า 45  |
|   | E:17  | หุ่นยนต์ทำความสะอาดบนพื้นที่ลื่นเกินไป   | ย้ายหุ่นยนต์และแท่นชาร์จไปยังตำแหน่งใหม่และเปิดใช้งานอีกครั้ง   |
| ไม่มีการแสดงสถานะการชาร์จ   | -   | เสียบสายไฟและอะแดปเตอร์ไม่แน่น และ/หรือไม่ได้เสียบกับแหล่งจ่ายไฟหลัก                   | เสียบตัวเชื่อมต่ออะแดปเตอร์เข้ากับแท่นชาร์จ เสียบสายไฟเข้ากับแหล่งจ่ายไฟหลัก ตรวจสอบดูให้แน่ใจว่าแท่นชาร์จบนหุ่นยนต์และแท่นชาร์จเชื่อมต่อกัน  |
|   |   | แท่นชาร์จบนหุ่นยนต์และแท่นชาร์จไม่ได้เชื่อมต่อกัน                                      | ตรวจสอบว่าไม่มีการชำรุดเสียหายบริเวณปลั๊กไฟและสายไฟ   |
| แบตเตอรี่หมดเร็ว  | -   | แบตเตอรี่หมดอายุ   | เปลี่ยนแบตเตอรี่ 2 ชุด ดูข้อมูล "การเปลี่ยนแบตเตอรี่" หน้า 47   |
| ปัญหาเกี่ยวกับแบตเตอรี่   | E:20  | นำแท่นชาร์จแบตเตอรี่ที่ไม่เหมาะสมมาใช้งาน  | ใช้แท่นชาร์จของแท่จากอีเลคโทรลักซ์ที่ให้มาพร้อมกับหุ่นยนต์เท่านั้น หากจำเป็นต้องเปลี่ยนแท่นชาร์จ ให้ใช้แท่นชาร์จอีเลคโทรลักซ์ (ANC: 406000071)  |
|   | E:21  | แบตเตอรี่ทำงานผิดปกติในระหว่างการใช้งาน  | เปลี่ยนแบตเตอรี่ 2 ชุด ดูข้อมูล "การเปลี่ยนแบตเตอรี่" หน้า 47   |
|   | E:22  | ผลิตภัณฑ์มีอุณหภูมิสูงเกินไป   | ให้หุ่นยนต์หยุดทำงานชั่วคราวนอกแท่นชาร์จเป็นเวลา 6 ชั่วโมง  |
|   | E:23  | ใส่แบตเตอรี่เข้าไปในหุ่นยนต์ไม่ถูกต้อง   | ใส่แบตเตอรี่เข้าไปในหุ่นยนต์ ดูข้อมูล "การเปลี่ยนแบตเตอรี่" หน้า 47   |

| ปัญหา   | รหัสข้อผิดพลาด | สาเหตุ   | วิธีแก้ไข   |
|---|----------------|--|---|
| หุ่นยนต์ไม่แสดงเวลา   | - - - -        | ไม่ได้ตั้งเวลาให้ตรงกับเวลาปัจจุบัน                  | เมื่อหุ่นยนต์เชื่อมต่อกับ WiFi จะมีการตั้งเวลาอัตโนมัติ   |
| เวลาที่แสดงบนหุ่นยนต์ไม่ถูกต้อง                             |                | หุ่นยนต์ไม่ได้อัปเดตเวลาที่ปัจจุบันจากเครือข่าย WiFi | ตรวจสอบให้แน่ใจว่าหุ่นยนต์ได้เชื่อมต่อกับเครือข่าย WiFi แล้ว และรอนจนกว่าจะได้รับเวลาที่ถูกต้อง หากหุ่นยนต์ไม่ได้อัปเดตเวลาใหม่ภายใน 24 ชั่วโมง ให้ดำเนินการตามขั้นตอนการเริ่มต้นใช้งานอีกครั้ง |
| หุ่นยนต์กลับมาที่แท่นชาร์จ โดยยังทำความสะอาดไม่ทั่วทั้งห้อง | -              | หุ่นยนต์เลือกกลับไปยังแท่นชาร์จเพื่อชาร์จแบตเตอรี่   | พื้นที่ที่แบตเตอรี่ชาร์จเต็มอีกครั้ง หุ่นยนต์จะทำงานตามโปรแกรมการทำทำความสะอาดต่อไปโดยอัตโนมัติ   |
| หุ่นยนต์ดูดน้ำเข้าไปในตัวเครื่อง                            | -              | -  | จำเป็นต้องเปลี่ยนมอเตอร์ ณ ศูนย์บริการอีเลคโทรลักซ์ที่ได้รับอนุญาต นำที่ไหลเข้ามาจะสร้างความเสียหายให้กับมอเตอร์ ซึ่งไม่อยู่ภายใต้การรับประกัน  |
| ปัญหาเกี่ยวกับซอฟต์แวร์                                     | E:30           | ซอฟต์แวร์ทำงานผิดปกติ                                | โปรดอัปเดตซอฟต์แวร์หุ่นยนต์   |
|   | E:31           | การอัปเดตซอฟต์แวร์ล้มเหลว                            | โปรดอัปเดตซอฟต์แวร์อีกครั้ง   |
| ต้องได้รับการซ่อมบำรุง                                      | E:40           | -  | โปรดติดต่อศูนย์บริการอีเลคโทรลักซ์ที่ได้รับอนุญาต   |
| ข้อผิดพลาดของระบบ   | E:41           | ข้อผิดพลาดภายใน                                      | โปรดเริ่มต้นการดำเนินการที่ต้องการใหม่  |
|   | E:42           |  |   |

หากพบปัญหาอื่นๆ โปรดดูข้อมูลพื้นที่ให้บริการในแอปหรือบนเว็บไซต์ของเรา

วัสดุสิ้นเปลืองและอุปกรณ์เสริม

 [www.electrolux.com/shop](http://www.electrolux.com/shop)

 ชุดอุปกรณ์ PUREi9 Performance Ref: ERK2 PNC: 9001677674

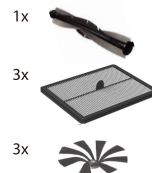

 หัวแปรง PUREi9 Power REF: EBSB2 PNC: 9001683938



 แท่นชาร์จ ANC: 406000071



 ชุดแบตเตอรี่ ANC: 405 537 959/0



GB  
CS  
CT  
ID  
KO  
TH  
VI

## Các biện pháp an toàn

Trẻ em từ 8 tuổi trở lên và những người có khuyết tật về thể chất, giác quan hoặc thần kinh hoặc thiếu kinh nghiệm và kiến thức chỉ được phép sử dụng thiết bị này nếu họ được giám sát hoặc chỉ dẫn sử dụng một cách an toàn và hiểu rõ các mối nguy hiểm liên quan.

Chỉ nên sử dụng robot để hút bụi thông thường ở môi trường trong nhà.

Đảm bảo rằng robot được cất giữ ở nơi khô ráo.

*Mọi công việc bảo dưỡng hoặc sửa chữa thiết bị phải do trung tâm dịch vụ được ủy quyền của Electrolux thực hiện.*

Tháo robot khỏi bộ sạc trước khi vệ sinh hoặc bảo trì.

Không để trẻ em nghịch thiết bị.

Không để các vật liệu đóng gói như túi nhựa hoặc túi vải gần tầm tay trẻ em để tránh gây ngạt thở.

Robot được thiết kế sử dụng với điện áp cụ thể. Kiểm tra xem điện áp nguồn có giống với điện áp ghi trên bảng định mức ở bộ sạc hay không.

Chỉ sử dụng giá sạc và bộ sạc chính hãng được thiết kế cho robot này

### Tuyệt đối không sử dụng robot:

- Ở khu vực ẩm ướt.
- Gần các loại khí dễ cháy, v.v..
- Khi sản phẩm có dấu hiệu hư hỏng rõ ràng.
- Trên các vật sắc nhọn hoặc chất lỏng.
- Trên xỉ than nóng hoặc nguội, mẩu thuốc lá đang cháy, v.v..
- Trên bụi mịn, như thạch cao, bê tông, bột mì, xỉ than nóng hoặc nguội.
- Không để robot tiếp xúc trực tiếp với ánh nắng mặt trời.
- Tránh để robot tiếp xúc với nguồn nhiệt mạnh.
- Không được tháo pin, gây đoản mạch hay đặt pin trên bề mặt kim loại. Chỉ sử dụng pin được thiết kế dành cho robot.
- Phải tháo pin khỏi thiết bị trước khi tiêu hủy.

- Phải rút phích cắm của thiết bị khi tháo pin.
- Pin phải được tiêu hủy an toàn.
- Tuyệt đối không sử dụng robot khi không có bộ lọc.
- Không chạm vào chổi lăn khi robot hút bụi đang bật và chổi lăn đang xoay. Không chạm vào bánh xe khi robot đang vận hành.

Việc không tuân thủ các khuyến cáo nêu trên khi sử dụng robot có thể gây ra thương tích cá nhân nghiêm trọng hoặc hư hỏng sản phẩm. Thương tích hoặc hư hỏng do không tuân thủ các khuyến cáo này sẽ không thuộc phạm vi bảo hành của Electrolux.

Bảo hành không bao gồm tuổi thọ pin giảm do lão hóa hoặc quá trình sử dụng, do tuổi thọ pin phụ thuộc vào thời gian và số lần sử dụng robot.

Trước khi vệ sinh, phải loại bỏ các vật nhỏ và dễ vỡ như vải, dây rèm, giấy hoặc dây điện khỏi sàn. Nếu thiết bị đề lên dây điện hoặc kéo dây điện, một vật nào đó sẽ có nguy cơ bị kéo ra khỏi bàn hoặc kệ.

Robot được thiết kế để không làm di chuyển các đồ vật lớn trên đường đi. Do đó, có thể để lại các đồ vật như ghế trên sàn do robot sẽ vệ sinh xung quanh chúng.

Ánh sáng mạnh, tường ốp kính, cửa sổ cao từ sàn đến trần nhà và các đồ vật quá sáng có thể gây nhiễu hệ thống hiển thị 3D.

### Truy cập trang web của chúng tôi để:



Xem lời khuyên về cách sử dụng, tài liệu giới thiệu, thông tin sửa chữa, bảo dưỡng:  
**[www.electrolux.com](http://www.electrolux.com)**



Đăng ký sản phẩm để nhận dịch vụ tốt hơn:  
**[www.electrolux.com/productregistration](http://www.electrolux.com/productregistration)**



Mua Phụ kiện và Vật tư tiêu hao cho thiết bị của bạn:  
**[www.electrolux.com/shop](http://www.electrolux.com/shop)**

## Môi trường vận hành, sạc và bảo quản được khuyến nghị dành cho các sản phẩm pin của Electrolux

### 1. Các điều kiện vận hành, sạc và bảo quản

Sản phẩm này được thiết kế để sử dụng ở môi trường trong nhà thông thường và không nên để sản phẩm tiếp xúc với nhiệt độ bất thường.

Để bảo vệ các bộ phận bên trong sản phẩm, không nên cất giữ, sạc hoặc vận hành sản phẩm ở:

- Nhiệt độ môi trường dưới 10°C hoặc trên 30°C.
- Nếu sản phẩm được cất giữ ở nhiệt độ dưới 10°C hoặc trên 30°C. Vui lòng chờ vài giờ để các bộ phận bên trong sản phẩm nguội hoặc nóng lên và sấy khô trước khi sử dụng. Việc sử dụng và bảo quản ngoài phạm vi nhiệt độ này có thể gây hư hại hoặc làm giảm tuổi thọ sản phẩm.
- Độ ẩm dưới 20% hoặc trên 80% (Không ngưng tụ)

Sạc sản phẩm trong thời gian tối thiểu 24 giờ:

- Trước khi sử dụng lần đầu.
- Trước khi bảo quản trong thời gian dài. (Tháo pin khỏi robot trước khi bảo quản trong thời gian dài.)
- Sau khi bảo quản trong thời gian dài.

### 2. Cảnh báo ngưng tụ hơi nước

Sản phẩm có thể bị ngưng tụ hơi nước bên trong ở các điều kiện sau:

- Thiết bị được di chuyển từ nơi lạnh sang nơi ấm.
- Dưới các điều kiện có độ ẩm rất cao.
- Sau khi sưởi ấm phòng lạnh.

Vui lòng chờ vài giờ để các bộ phận bên trong sản phẩm nóng lên và sấy khô trước khi sử dụng.

### 3. Để duy trì tuổi thọ pin và hiệu suất máy:

- Luôn sạc robot khi không sử dụng.
- Sạc trong thời gian sớm nhất sau chu kỳ vệ sinh. Việc để quá lâu không sạc có thể ảnh hưởng đến pin.

## Các vấn đề về môi trường



Biểu tượng này trên sản phẩm cho biết sản phẩm có chứa pin sạc tích hợp, không được tiêu hủy pin này chung với rác thải sinh hoạt thông thường.



Biểu tượng này trên sản phẩm hoặc bao bì sản phẩm cho biết rằng không được xử lý sản phẩm này như rác thải gia đình.

Để tái chế sản phẩm, vui lòng đưa sản phẩm đến điểm thu gom chính thức hoặc trung tâm dịch vụ của Electrolux, nơi có thể tháo và tái chế pin và các bộ phận điện tử một cách an toàn và chuyên nghiệp. Tuân thủ theo các quy định tại quốc gia của bạn về thu gom riêng các sản phẩm điện và pin sạc.

## Chăm sóc khách hàng và dịch vụ

Khi liên hệ với trung tâm dịch vụ của Electrolux, hãy đảm bảo rằng bạn chuẩn bị sẵn các dữ liệu sau:

- Số model,
- Số PNC
- Số sêri

Có thể tìm thấy thông tin trên nhãn thiết bị.

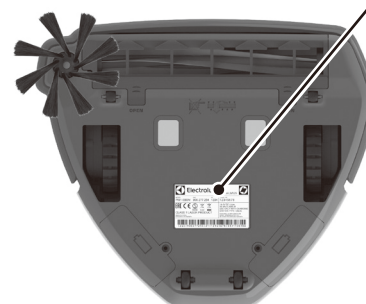
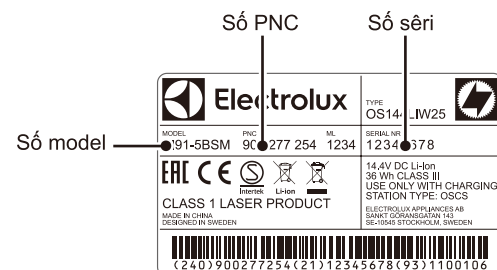

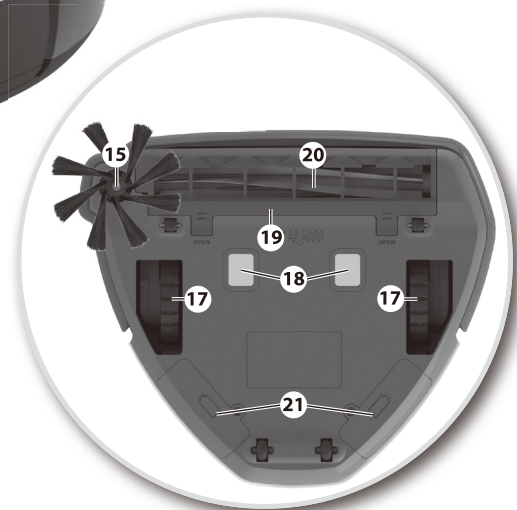
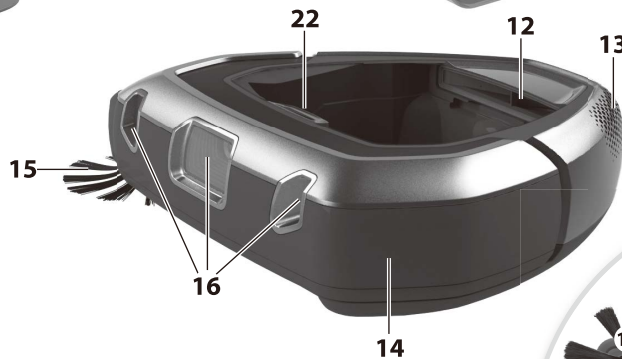
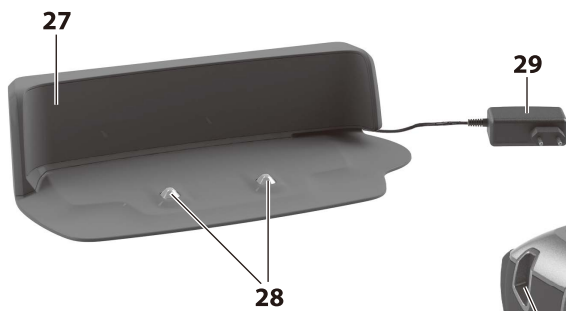
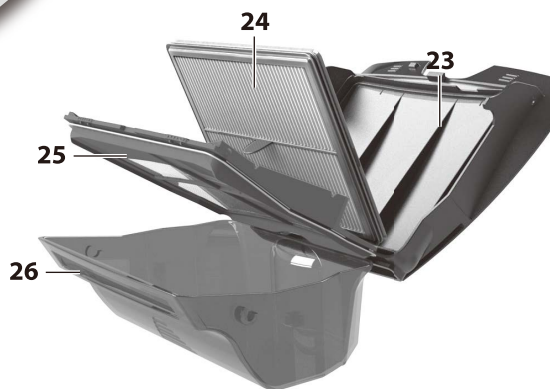
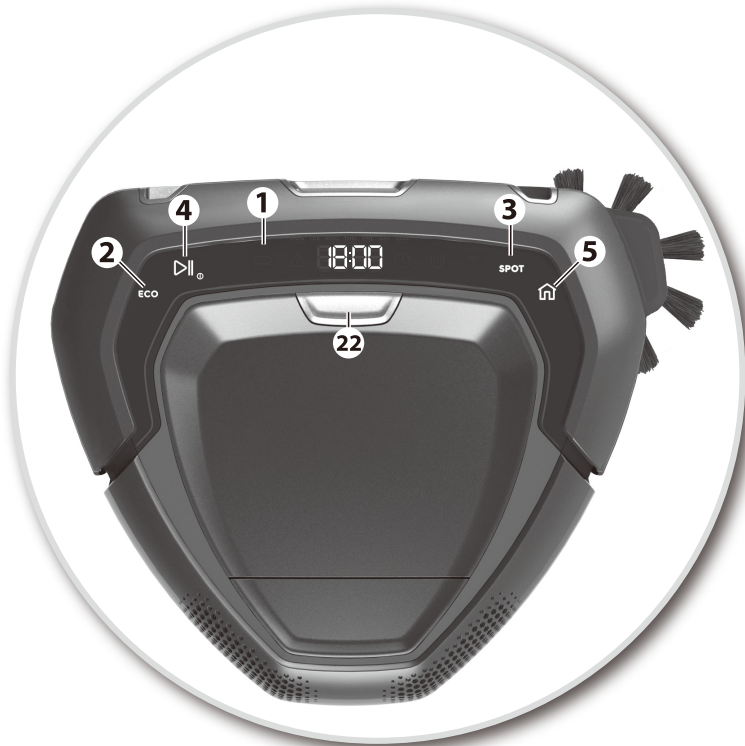

## Tiếng Việt

### Trước khi khởi động

- Mở hộp robot hút bụi Electrolux PUREi9 và đảm bảo rằng tất cả các phụ kiện đều đầy đủ.\*
- Đọc kỹ sách hướng dẫn sử dụng.
- Đặc biệt lưu ý chương Lời khuyên về an toàn.

*Chúng tôi khuyên bạn nên tải về ứng dụng "PUREi9" và cập nhật phần mềm trước khi sử dụng lần đầu.*

Chúc bạn sử dụng robot hút bụi Electrolux PUREi9 hiệu quả!

### Mục lục:

|  |    |
|--|----|
| Các biện pháp an toàn                                  | 50 |
| Thông tin khách hàng và chính sách phát triển bền vững | 50 |
| Cách sử dụng robot.                                    | 54 |
| Cách kết nối với ỨNG DỤNG "PUREi9"                     | 55 |
| Lời khuyên về cách đạt kết quả tốt nhất                | 57 |
| Đổ hộp chứa bụi  | 59 |
| Vệ sinh/Thay bộ lọc.                                   | 59 |
| Vệ sinh và bảo trì.                                    | 60 |
| Sạc pin.   | 61 |
| Xử lý lỗi  | 61 |
| Khắc phục sự cố  | 62 |

### Mô tả về robot hút bụi

- 1 Màn hình / Bảng điều khiển
- 2 Nút chức năng ECO
- 3 Nút vệ sinh SPOT
- 4 Nút Chạy/Tạm dừng / nút Tắt (nhấn và giữ)
- 5 Nút Home
- 6 Đồng hồ
- 7 Đèn báo hộp chứa bụi
- 8 Đèn báo kết nối WIFI
- 9 Đèn báo vệ sinh theo lịch
- 10 Đèn cảnh báo
- 11 Đèn báo tình trạng pin
- 12 Bộ phận quạt
- 13 Cửa thoát khí
- 14 Giảm chấn
- 15 Chổi phụ
- 16 Hệ thống hiển thị 3D (Camera)
- 17 Bánh xe chính
- 18 Giắc cắm sạc
- 19 Nắp chổi lăn
- 20 Chổi lăn
- 21 Ngăn chứa pin
- 22 Nút tháo hộp chứa bụi
- 23 Nắp hộp chứa bụi
- 24 Bộ lọc
- 25 Khung bộ lọc (và lưới lọc)
- 26 Hộp chứa bụi
- 27 Đế sạc
- 28 Giắc cắm sạc
- 29 Bộ chuyển đổi nguồn và dây nguồn

\*Phụ kiện có thể khác nhau tùy theo model.

## Lắp đặt robot hút bụi

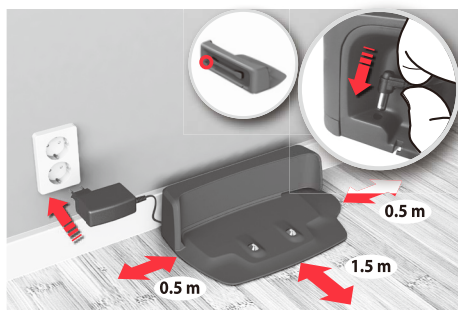

**1. Đặt đế sạc trên sàn và tựa vào tường.** Cắm bộ sạc vào giắc cắm ở dưới đế. Cắm phích cắm dây điện vào ổ cắm nguồn. Quấn phần dây thừa phía sau đế. Đảm bảo chừa lại khoảng trống 0,5 m ở các bên và 1,5 m ở phía trước của đế sạc.

**Model có wifi:** Đặt đế trong phạm vi phát sóng của bộ định tuyến wifi.



**2. Lắp chổi phụ.**

**Lưu ý:** Nếu sử dụng robot để vệ sinh phòng có thảm phủ kín sàn, hãy tháo chổi phụ để đạt được kết quả vệ sinh tốt nhất.



**3. Đặt robot lên đế sạc.**

Biểu tượng pin sẽ nhấp nháy cho biết robot đang được sạc.

## Trạng thái pin/sạc

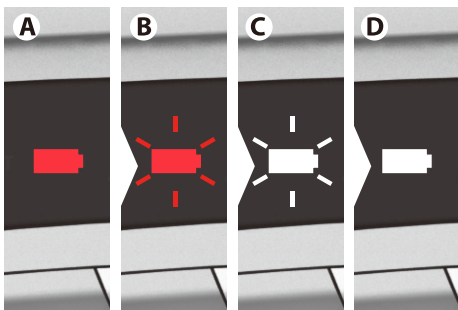

**1. Pin màu đỏ (A)** cho biết rằng robot cần được sạc.

**Đèn màu đỏ nhấp nháy (B):** Robot đang sạc – Mức pin thấp.

**Đèn màu trắng nhấp nháy (C):** Robot đã được sạc đủ để sử dụng. (Nhấn nút Chạy/Tạm dừng để vệ sinh.)

**Đèn màu trắng (D):** Robot đã sẵn sàng để sử dụng. Thời gian sạc đầy là ~3 giờ.



**2. Để duy trì tuổi thọ pin và hiệu suất máy:**

- Luôn sạc robot khi không sử dụng.
- Đặt máy vào để sạc để sạc trong thời gian sớm nhất sau chu kỳ vệ sinh. Việc để quá lâu không sạc có thể ảnh hưởng đến pin.

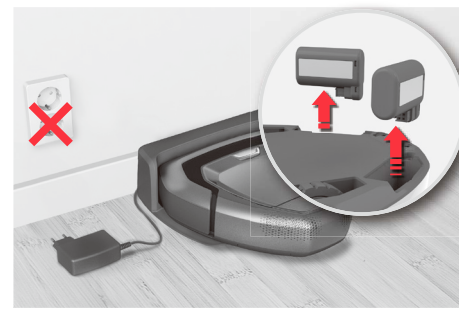

**3. Bảo quản (không cắm điện):** Trong trường hợp robot được bảo quản mà không sạc trong thời gian dài, hãy tháo pin và cất vào một chỗ riêng. (Sạc trước khi tháo pin khỏi robot).

Để tháo pin, xem hướng dẫn trên trang 61.

Cách kết nối với ỨNG DỤNG "PUREi9"

Chúng tôi khuyên bạn nên tải về ứng dụng và cập nhật phần mềm trước khi sử dụng lần đầu.



1. Tải về ứng dụng "PUREi9" trong Kho ứng dụng hoặc Google play, sau đó thực hiện theo hướng dẫn để tạo tài khoản và kết nối với robot.

**Lưu ý:** Đảm bảo rằng điện thoại đã được kết nối với wifi gia đình (2.4 GHz).



2. Trong quá trình này, ứng dụng sẽ yêu cầu bạn lật ngược robot để kích hoạt mô-đun wifi và quét mã vạch số sêri (A) hoặc nhập thủ công mã vạch (B). Sau đó tiếp tục thực hiện theo hướng dẫn của ứng dụng.

**Lưu ý:** trước khi lật robot, đảm bảo rằng robot đã được bật trong ít nhất một phút.



3. Khi hoàn tất thiết lập, chuyển robot quay lại vị trí bình thường. Biểu tượng wifi (A) sẽ phát sáng để cho biết robot đã được kết nối với mạng gia đình. **Lưu ý:** đồng hồ robot có thể mất một lúc để tự động đồng bộ với thiết bị di động của bạn.

**Lưu ý:** Biểu tượng wifi nhấp nháy cho biết robot đang cố gắng kết nối với mạng.

Lịch vệ sinh



Có thể lên lịch vệ sinh trong ỨNG DỤNG (Ngày & giờ)

Các chế độ vệ sinh

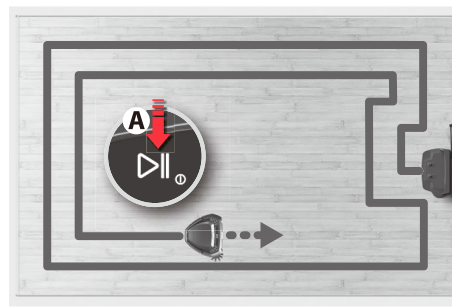

1. Nhấn nút Chạy/Tạm dừng (A) để bắt đầu vệ sinh. Sau vài giây khởi động, máy bắt đầu vệ sinh. Robot sẽ tự động vệ sinh dọc theo tường, từ ngoài vào trong.

**Lưu ý:** Nhấn nhanh nút "Chạy/Tạm dừng" (A) để tạm dừng vệ sinh hoặc nhấn và giữ để dừng vệ sinh.

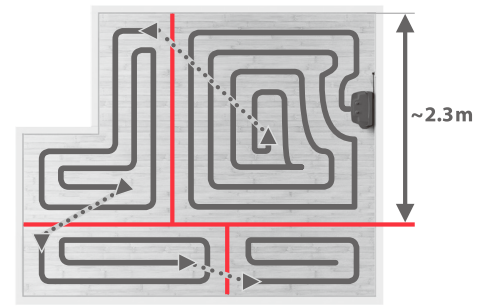

2. Phòng lớn sẽ được chia thành các ô có diện tích tối đa 2 x 2.3 m.

**Lưu ý:** Công tác vệ sinh sẽ hiệu quả hơn nếu robot bắt đầu làm việc từ gần tường.

**Tự động quay lại để sạc/sạc**

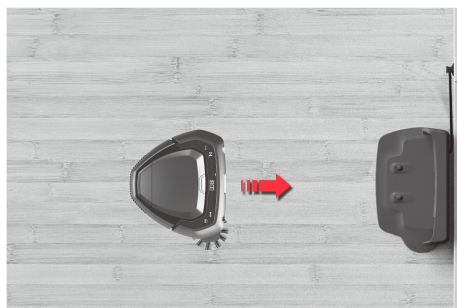

**Khi vệ sinh xong**, robot sẽ tự động quay lại để sạc.

**Lưu ý:** Nếu robot không bắt đầu từ để sạc, nó sẽ quay lại vị trí ban đầu khi vệ sinh xong.

**Tự động sạc trong chu kỳ vệ sinh**

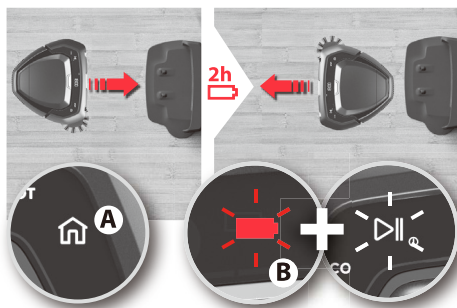

**Nếu cần sạc trong quá trình vệ sinh**, nút home sẽ sáng và robot sẽ quay lại để sạc. Nút Home (A) sáng. Pin và nút Chạy/Tạm dừng (B) nhấp nháy cho biết robot đang sạc và sẽ tiếp tục vệ sinh tại vị trí đã dừng. Robot sẽ sạc lại đến 90% để tiếp tục vệ sinh nhanh hơn. Thời gian sạc là ~2 giờ.

**Đi qua ngưỡng cửa**

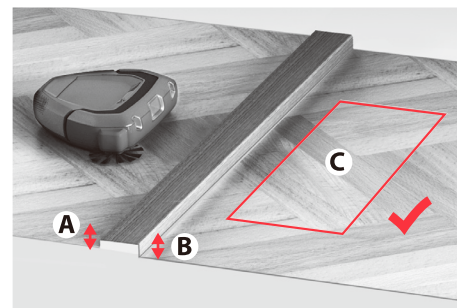

**Trước khi đi qua một ngưỡng cửa hoặc trèo qua một vật cản bất kỳ**, robot sẽ dừng lại và kiểm tra:

- chiều cao (A & B) ở hai bên của ngưỡng cửa/vật cản
- khu vực ở bên còn lại đã sẵn sàng để vệ sinh chưa (C)

**Chế độ ECO (tiết kiệm điện)**



**Chế độ ECO:** Để vệ sinh đơn giản, nhấn nút ECO để giảm công suất, kéo dài thời gian hoạt động và giảm độ ồn. Robot sẽ ở chế độ ECO cho đến khi nhấn nút lần nữa.

**Quay lại**

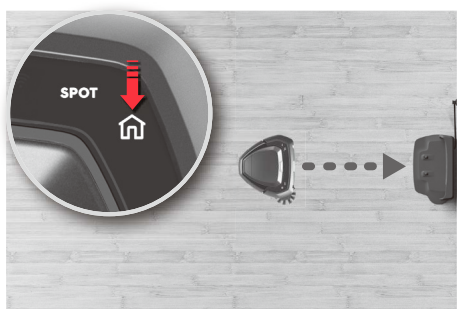

**Dừng vệ sinh và đưa robot về để sạc:** Ấn nút Home. Nếu robot không được khởi động từ để sạc, nó sẽ quay lại vị trí bắt đầu.

**Vệ sinh SPOT (từng chỗ)**

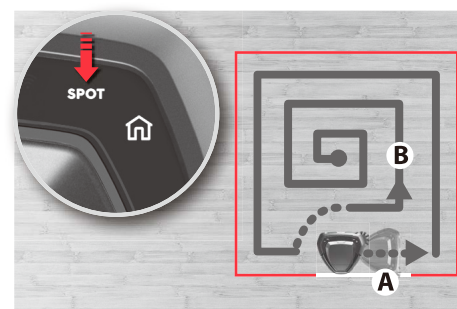

**Vệ sinh SPOT (diện tích nhỏ, ~1 m2):** Đặt robot hướng về khu vực cần vệ sinh và nhấn nút SPOT. Robot sẽ vệ sinh khu vực hai lần.

## Chuẩn bị khu vực vệ sinh

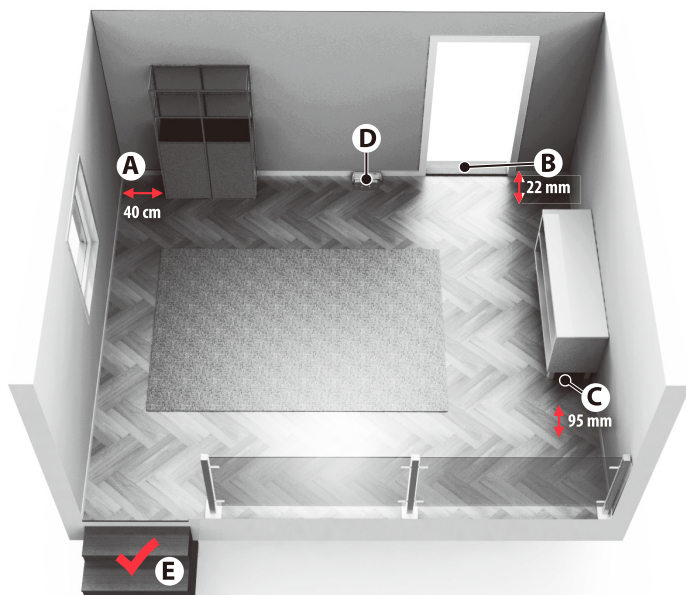

- (A) Chừa lại khoảng cách 40 cm xung quanh các đồ đạc không có chân.
- (B) Robot sẽ dễ dàng đi qua ngưỡng cửa có chiều cao lên tới 22 mm.
- (C) Robot có thể vệ sinh bên dưới các đồ đạc có khoảng trống bên dưới từ 95 mm trở lên.
- (D) Đặt đế sạc ở bên trái cửa.
- (E) Robot có thể phát hiện bậc thang và dốc sâu.

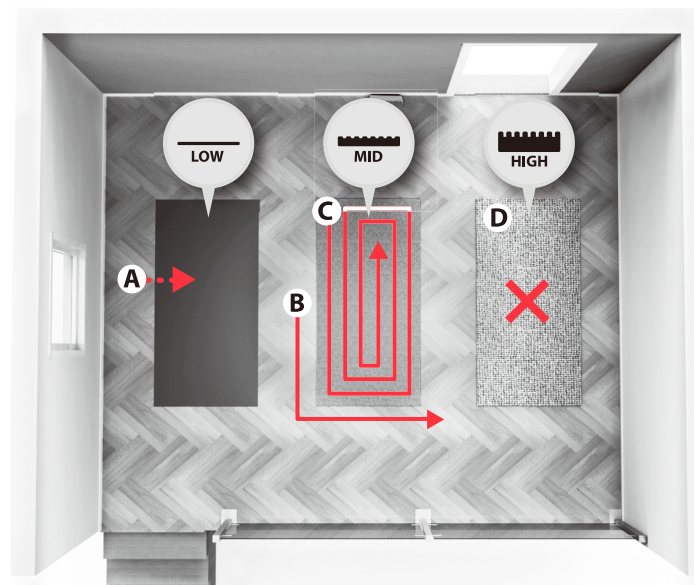

**Thảm:** Robot vệ sinh

- **thảm mỏng:** (A) giống như vệ sinh phòng
- **thảm có độ dày trung bình:** (B) trước tiên vệ sinh xung quanh thảm (C) và sau đó quay lại để vệ sinh thảm riêng
- **thảm dày:** (D) không được vệ sinh. Khi robot đến mép thảm, nó sẽ tiếp tục vệ sinh các khu vực còn lại khác.

## Chuẩn bị khu vực vệ sinh

Trước khi vệ sinh, phải loại bỏ các vật nhỏ và dễ vỡ như vải, dây rèm, giấy hoặc dây điện ra khỏi sàn. Nếu thiết bị đè lên dây điện hoặc kéo dây điện, một đồ vật nào đó sẽ có nguy cơ bị kéo ra khỏi bàn hoặc kệ.

Do đó, có thể để lại các đồ vật lớn/cao như ghế trên sàn do robot sẽ vệ sinh xung quanh chúng.

Ánh sáng mạnh, tường ốp kính, cửa sổ cao từ sàn đến trần nhà và các đồ vật quá sáng có thể gây nhiễu hệ thống hiển thị 3D.

## Giới hạn khu vực vệ sinh

Robot sẽ vệ sinh tất cả các sàn mà nó có thể tiếp cận. Để giới hạn khu vực vệ sinh, chỉ cần đóng cửa hoặc đặt một vật cản.

## Đổ hết bụi sau khi vệ sinh theo lịch

Để việc vệ sinh theo lịch đạt kết quả cao nhất, hãy định kỳ đổ hộp chứa bụi.



**Luôn cầm robot bằng hai tay để trước ngực.**

**Di chuyển robot thủ công:**

Không nên di chuyển robot trong quá trình vệ sinh, do robot có thể khởi động lại quá trình vệ sinh từ đầu.

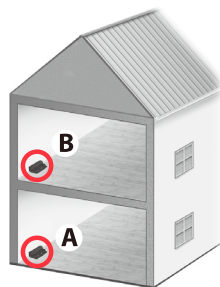

**Khi vệ sinh một ngôi nhà có nhiều tầng, có thể sử dụng thêm để sạc ở mỗi tầng.**

(ANC: 406000071)

**Hướng dẫn tắt Robot hút bụi**

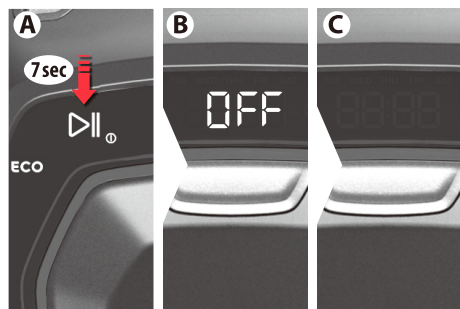

**Hướng dẫn tắt Robot hút bụi:** Robot được thiết lập để có thể tắt hoàn toàn khi bạn không sử dụng trong một khoảng thời gian dài nhất định. Để thực hiện, vui lòng làm theo các bước sau:

- Nhấn giữ nút Play (hình A) trên Robot trong khoảng thời gian 7 giây.
- Chữ "OFF" xuất hiện trên màn hình (hình B).
- Khi màn hình tối hẳn, Robot đã được tắt hoàn toàn (hình C).

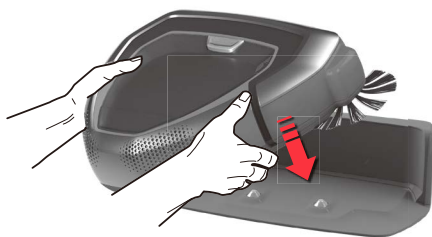

**Để khởi động lại và sử dụng Robot, vui lòng đặt Robot vào đế sạc.** Bạn hoàn toàn có thể tắt Robot khi đang đặt ở đế sạc, để khởi động lại vui lòng nhắc Robot lên và đặt trở lại đế sạc.

## Đổ hộp chứa bụi



- Đổ hộp chứa bụi thường xuyên** hoặc khi biểu tượng hộp chứa bụi sáng.  
 Nếu biểu tượng hộp chứa bụi vẫn sáng khi hộp rỗng, vui lòng vệ sinh bộ lọc.

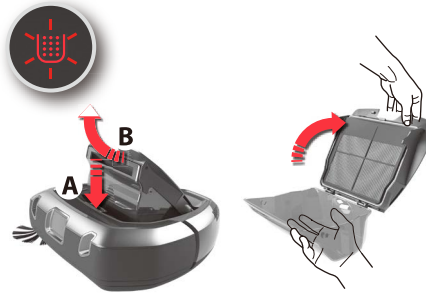

- Nhấn nút Nhà (A), tháo hộp chứa bụi bằng cách kéo nó lên (B).**  
 Mở nắp bằng cách kéo nắp lên.  
 Đổ hộp chứa bụi vào thùng rác.  
**Lưu ý:** Biểu tượng hộp chứa bụi nhấp nháy cho biết hộp chứa bụi đã được tháo hoặc không ở đúng vị trí.



- Sau khi đổ hộp chứa bụi, đóng nắp và đặt lại hộp vào vị trí.**  
 Lắp lại hộp chứa bụi vào robot.  
**Lưu ý:** Khi hộp chứa bụi không được lắp đúng cách, nếu nhấn nút Chạy/Tạm dừng, biểu tượng hộp chứa bụi sẽ nhấp nháy. Lắp lại hộp chứa bụi đúng cách.

GB  
CS

CT  
ID

KO  
TH

VI

## Vệ sinh bộ lọc

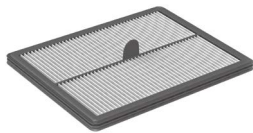

- Để đạt được hiệu quả tốt nhất, chúng tôi khuyên bạn nên vệ sinh bộ lọc** sau 5 lần hút bụi và thay bộ lọc sau 6 tháng.  
 (Mã tham chiếu: ERK2)

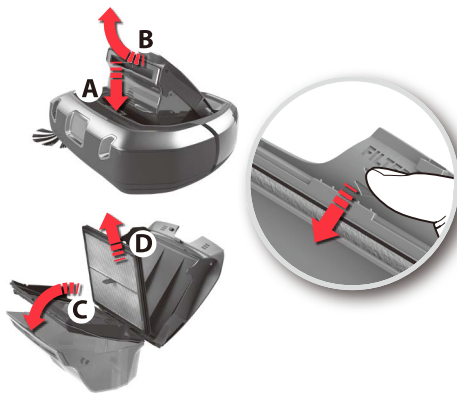

- Tháo bộ lọc:**  
 Tháo hộp chứa bụi bằng cách kéo nó lên (B).  
 Mở nắp bằng cách kéo nắp lên.  
 Kéo khung bộ lọc xuống (C).  
 Tháo bộ lọc (D).

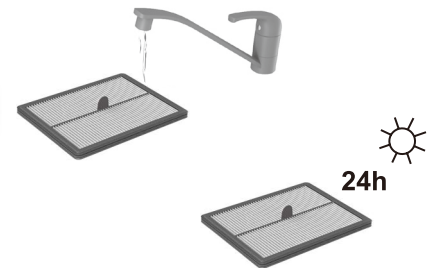

- Rửa sạch bộ lọc bằng nước lạnh.** Vỗ nhẹ vào khung bộ lọc để nước ra hết. Để khô trong 24 giờ trước khi lắp bộ lọc vào máy.

### Vệ sinh hệ thống hiển thị 3D (Camera)



Hệ thống hiển thị 3D hoạt động tốt nhất nếu các cửa sổ (A,B,C) được giữ sạch sẽ và không bị xước.

Vệ sinh vết bẩn nhẹ bằng cách dùng giẻ mềm khô. Nếu vết bẩn nghiêm trọng, bạn có thể sử dụng chất tẩy nhẹ để làm sạch.

### Làm sạch bánh xe



1. Loại bỏ tóc rối hoặc các vật tương tự khỏi bánh xe chính để chúng có thể quay dễ dàng.

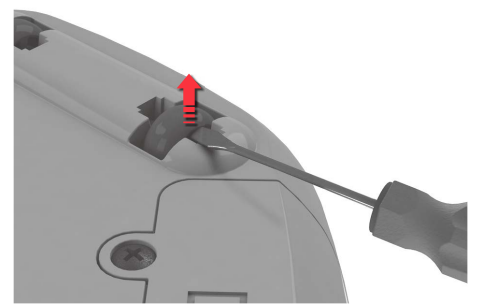

2. Nếu bánh xe nhỏ bị kẹt, hãy tháo chúng cẩn thận bằng cách sử dụng tua vít nhỏ và vệ sinh các bánh xe.

### Vệ sinh chổi phụ

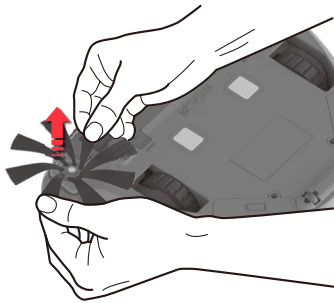

Kéo chổi phụ để tháo ra. Vệ sinh chổi phụ. Lắp lại chổi phụ vào hộc. Có thể thay chổi phụ. (Mã tham chiếu: ERK2 / EBSB2)

### Tháo chổi lăn.



1. Ấn vào hai chốt và trượt nắp về phía trước để tháo nắp chổi lăn.



2. Kéo chổi lăn ra và vệ sinh chổi và ổ trục. Tháo các sợi chỉ bị quấn vào bằng cách dùng kéo cắt. Lắp lại theo trình tự ngược lại. Có thể thay chổi lăn (Mã tham chiếu: ERK2)

### Vệ sinh Ống thông khí



**Tháo hộp chứa bụi.** Tháo rác bẩn bị tắc trong ống thông khí. Đặt hộp chứa bụi vào.

### Thay pin

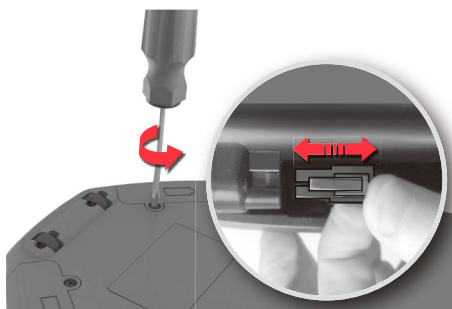

**1. Ngăn chứa pin nằm ở mặt dưới của robot.** Dùng tua vít (PH2) để tháo nắp ngăn chứa pin. Tháo pin và lắp lại nắp ngăn chứa pin.  
**⚠️Cẩn thận!** Đảm bảo thay hai cục pin cùng lúc.

**2. Chỉ sử dụng pin của nhà cung cấp chính hãng.**

Pin phải được tháo và tiêu hủy an toàn trước khi tiêu hủy máy.  
(ANC: 405 537 959/0)



GB  
CS

CT  
ID

KO  
TH

VI

### Lau chùi điểm tiếp xúc của bộ phận sạc



Quý khách hàng vui lòng sử dụng miếng vải mềm để lau chùi thường xuyên điểm tiếp xúc của bộ phận sạc và bên dưới thân máy.

### Xử lý lỗi



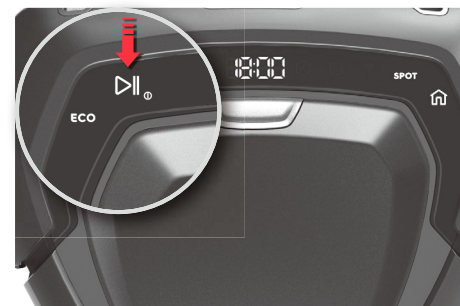

**1. Nếu xảy ra lỗi,** robot sẽ dừng hoạt động. Biểu tượng cảnh báo sẽ nhấp nháy và các chữ số "E:" theo sau là mã lỗi được hiển thị trên màn hình. Loa cũng sẽ phát mô tả lỗi. Sau khi xảy ra lỗi, nhấn nút bất kỳ để phát thông báo âm thanh lần nữa.



**2. Khi lỗi được xử lý,** nhấn nút Chạy/Tạm dừng để bắt đầu vệ sinh.  
**Lưu ý:** Để biết danh sách mã lỗi và cách khắc phục hoàn chỉnh, xem hướng dẫn trong "Xử lý sự cố".

## Khắc phục sự cố

| Sự cố   | Mã lỗi  | Nguyên nhân  | Giải pháp   |
|---|---|--|---|
| Màn hình trống.   | -   | Hết pin.   | Sạc pin.  |
| Robot không khởi động.  |          | Không có hộp chứa bụi hoặc hộp được đóng nắp không đúng cách.  | Đặt hộp chứa bụi vào robot, đóng nắp đúng cách.   |
|   | <br>(x3) | Robot bị nâng lên.   | Đặt robot trên sàn trước khi khởi động.   |
| Robot không di chuyển/dọn dẹp đúng cách..   | E:10  | Giảm chấn bị kẹt   | Hãy đảm bảo rằng giảm chấn có thể di chuyển dễ dàng và loại bỏ bất kỳ mảnh vỡ nào có thể cản đường robot.   |
|   | E:11  | Bánh xe phải bị kẹt  | Kiểm tra xem tất cả các bộ phận có hoạt động dễ dàng không. Làm sạch và gỡ bỏ tóc rối khỏi các bộ phận nếu có. Thay chổi lăn hoặc chổi phụ nếu bị hỏng.<br><i>Tham khảo "Vệ sinh và bảo trì" trang 60</i> |
|   | E:12  | Bánh xe trái bị kẹt  |   |
|   | E:13  | Chổi lăn bị kẹt  |   |
|   | E:14  | Chổi phụ bị kẹt  |   |
|   | E:15  | Robot bị kẹt hoặc không thể điều hướng.  | Nâng và đặt robot ở nơi robot có thể di chuyển tự do. <i>Tham khảo "Lời khuyên về cách để đạt được kết quả tốt nhất" trang 57.</i>  |
|   | E:16  | Hệ thống hiển thị 3D bị che khuất hoặc bị bụi.   | Làm sạch hệ thống hiển thị 3D và đảm bảo rằng không có gì ngăn cản tầm nhìn. <i>Tham khảo "Vệ sinh và bảo trì" trang 60.</i>  |
|  | Hộp chứa bụi đầy hoặc bị tắc.   | Đổ và/hoặc vệ sinh hộp chứa bụi. <i>Tham khảo "Đổ hộp chứa bụi" trang 59.</i>  |   |
| E:17  | Robot đang hoạt động trên bề mặt quá trơn trượt.  | Di chuyển robot và bộ sạc sang vị trí mới và bắt đầu lại.  |   |
| Không có dấu hiệu sạc   | -   | Dây nguồn hoặc bộ sạc không được lắp và/hoặc kết nối với nguồn điện đúng cách.<br>Các tấm sạc trên robot và đế sạc không được kết nối. | Nối giắc cắm bộ đổi nguồn với đế sạc. Nối dây điện với nguồn điện. Đảm bảo rằng các tấm sạc trên robot và đế sạc được kết nối.<br><br>Kiểm tra xem phích cắm và cáp có bị hỏng không.                     |
| Nhanh hết pin   | -   | Tuổi thọ pin đã hết.   | Thay 2 cục pin. <i>Tham khảo "Thay pin" trang 61.</i>   |
| Các vấn đề về pin   | E:20  | Sử dụng sai đế sạc.  | Chỉ sử dụng đế sạc Electrolux ban đầu được cung cấp cùng với robot. Nếu cần phải thay thế đế sạc; hãy sử dụng đế sạc của Electrolux (ANC: 406000071).   |
|   | E:21  | Pin bị trục trặc trong quá trình sử dụng.  | Thay 2 cục pin. <i>Tham khảo "Thay pin" trang 61.</i>   |
|   | E:22  | Nhiệt độ sản phẩm quá cao.   | Đặt robot dừng lại bên ngoài trạm sạc trong 6 giờ.  |
|   | E:23  | Pin không được kết nối đúng cách với robot.  | Kết nối pin với robot. <i>Tham khảo "Thay pin" trang 61.</i>  |

| Sự cố  | Mã lỗi | Nguyên nhân   | Giải pháp  |
|--|--------|---|--|
| Thời gian không được hiển thị.                                       | - :- - | Chưa cài đặt thời gian hiện tại.                      | Khi kết nối robot với wifi, thời gian sẽ tự động cài đặt.  |
| Robot hiển thị sai thời gian.  |        | Robot chưa nhận được thời gian cập nhật từ mạng wifi. | Đảm bảo rằng robot được kết nối với mạng wifi và đợi cho đến khi robot nhận đúng thời gian. Nếu robot không cập nhật trong vòng 24 giờ, hãy thực hiện lại quy trình ban đầu. |
| Phòng chưa được vệ sinh sạch sẽ, nhưng robot đã quay trở lại để sạc. | -      | Robot quay trở lại để sạc để sạc pin.                 | Robot sẽ tự động tiếp tục chương trình làm sạch ngay sau khi pin được sạc lại.   |
| Nước bị hút vào robot.   | -      | -   | Cần thay thế động cơ tại trung tâm dịch vụ được ủy quyền của Electrolux. Hư hỏng động cơ do sự xâm nhập của nước không được bảo hành.  |
| Sự cố phần mềm   | E:30   | Phần mềm không hoạt động chính xác.                   | Vui lòng cập nhật phần mềm của robot.  |
|  | E:31   | Nâng cấp phần mềm thất bại.                           | Vui lòng cập nhật lại phần mềm.  |
| Dịch vụ cần thiết  | E:40   | -   | Liên hệ trung tâm dịch vụ được ủy quyền của Electrolux.  |
| Lỗi hệ thống   | E:41   | Lỗi bên trong.  | Vui lòng khởi động lại thao tác mong muốn.   |
|  | E:42   |   |  |

**Với các sự cố khác, vui lòng kiểm tra khu vực dịch vụ trong ỨNG DỤNG hoặc trên website của chúng tôi.**

## Vật tư tiêu hao &amp; Phụ kiện

 [www.electrolux.com/shop](http://www.electrolux.com/shop)

 Bộ công cụ hiệu suất PUREi9  
Ref: ERK2  
PNC: 9001677674

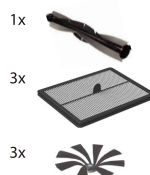

 Chổi điện PUREi9  
REF: EBSB2  
PNC: 9001683938



 Đế sạc  
ANC: 406000071



 Pin  
ANC: 405 537 959/0



## 中国

伊莱克斯（中国）电器有限公司 上海小家电分公司  
中国，上海，静安区共和新路1968号大宁国际广场  
8号楼606室  
办公电话: +86 21 3178 1000  
传真: +86 21 3387 0368  
售后服务: +86 800 820 0096  
+86 9510 5801  
网站: [www.electrolux.com.cn](http://www.electrolux.com.cn)

## KOREA

Electrolux Korea limited  
9F, Pine Avenue B,  
100 Euljiro, Jung-gu, Seoul, Korea 04551  
Tel: +(82) 2 6020-2200  
Fax: +(82) 2 6020-2271~3  
Customer Care Services: +(82) 1566-1238  
Email: [homecare.krh@electrolux.com](mailto:homecare.krh@electrolux.com)  
Website: [www.electrolux.co.kr](http://www.electrolux.co.kr)

## INDONESIA

PT Electrolux Indonesia  
Gedung Plaza Kuningan  
Menara Utara 2nd Floor, Suite 201.  
Jl. HR Rasuna Said kav C 11-14, Karet Setiabudi  
Jakarta Selatan 12940  
Indonesia  
Tel: +(62) 21 522 7099  
Fax: +(62) 21 522 7098  
Customer Care Services: +(62) 0804 111 9999  
Email: [customer-care@electrolux.co.id](mailto:customer-care@electrolux.co.id)  
Website: [www.electrolux.co.id](http://www.electrolux.co.id)  
DEPDAG: I.31.EI12.01301.1016

## THAILAND

Electrolux Thailand Co Ltd  
Electrolux Building  
14th Floor 1910 New Petchburi Road  
Bangkapi, Huay Kwang  
Bangkok 10310  
Thailand  
Tel: +(66) 2 725 9100  
Fax: +(66) 2 725 9299  
Customer Care Services: +(66) 2 725 9000  
Email: [customer-care@electrolux.co.th](mailto:customer-care@electrolux.co.th)  
Website: [www.electrolux.co.th](http://www.electrolux.co.th)

## MALAYSIA

Electrolux Home Appliances Sdn Bhd  
Lot C6, No. 28, Jalan 15/22, Taman  
Perindustrian Tiong Nam, 40200 Shah Alam,  
Selangor  
Customer Care Services:  
Tel: (+60 3) 5525 0800  
Fax: (+60 3) 5524 2521  
Email: [Malaysia.customer-care@electrolux.com](mailto:Malaysia.customer-care@electrolux.com)  
Website: [www.electrolux.com.my](http://www.electrolux.com.my)

## 台灣

新加坡商伊萊克斯股份有限公司 台灣分公司  
22065新北市板橋區縣民大道2段68號9F  
免付費客服專線: 0800-888-259  
傳真: 886-2-8964-5269  
電郵: [service@electrolux.com.tw](mailto:service@electrolux.com.tw)  
網站: [www.electrolux.com.tw](http://www.electrolux.com.tw)

## SINGAPORE

Electrolux SEA Pte Ltd  
1 Fusionopolis Place, Galaxis #07-10 (West Lobby)  
Singapore 138522  
Fax: +(65) 6727 3611  
Customer Care Services: +(65) 6727 3699  
Email: [customer-care.sin@electrolux.com](mailto:customer-care.sin@electrolux.com)  
Website: [www.electrolux.com.sg](http://www.electrolux.com.sg)

## PHILIPPINES

Electrolux Philippines Inc.  
10th Floor, W5th Avenue Building  
5th Avenue Corner 32nd Street  
Bonifacio Global City,  
Taguig Philippines 1634  
Tel: +(63) 2 737 4756  
Domestic Toll Free: 1 800 10 845 care 2273  
Customer Care Trunkline: (+63 2) 845-CARE (2273)  
Email: [wecare@electrolux.com](mailto:wecare@electrolux.com)  
Website: [www.electrolux.com.ph](http://www.electrolux.com.ph)

## VIETNAM

Electrolux Vietnam Ltd  
Floor 9th, A&B Tower  
76 Le Lai Street  
Ben Thanh Ward - District 1  
Ho Chi Minh City  
Vietnam  
Tel: +(84) 8 3910 5465  
Fax: +(84) 8 3910 5470  
Customer Care Services: 1800-58-8899  
Email: [customer-care@electrolux.com.vn](mailto:customer-care@electrolux.com.vn)  
Website: [www.electrolux.vn](http://www.electrolux.vn)

## NEW ZEALAND

Electrolux Small Appliances  
A division of Electrolux (NZ) Limited  
3-5 Niall Burgess Road, Mt. Wellington, Auckland,  
New Zealand  
Phone: (09) 9573 2220  
Customer Service Phone: 0508 730 730  
Website: [www.electrolux.com](http://www.electrolux.com)

## 大昌貿易行有限公司

電器維修中心  
香港葵涌葵樂街2-28號  
裕林貨倉大廈C座8樓  
免付費客服專線: 0800-888-259  
服務熱線: (+852) 8203 0298  
電子郵件: [dhead@eadchcomhk](mailto:dhead@eadchcomhk)  
網頁: [www.electrolux.com.hk](http://www.electrolux.com.hk)

## AUSTRALIA

Electrolux Home Products Pty Ltd  
ABN 51 004 762 341  
163 O'Riordan Street, Mascot, NSW 2020, Australia  
Customer Service Phone: 1300 365 305  
Website: [www.electrolux.com](http://www.electrolux.com)

The software in the robot is partly based on free and open source software.  
To access the source code of these components and to see the full copyright information and  
applicable license terms, please visit: [www.electrolux.com/rvc-supplementary](http://www.electrolux.com/rvc-supplementary)

For control according to international standards, please visit:  
[www.electrolux.com/rvc-supplementary](http://www.electrolux.com/rvc-supplementary)



Share more of our thinking at [electrolux.com](https://electrolux.com)



[electrolux.com/shop](https://electrolux.com/shop)

Electrolux Appliances AB  
Sankt Göransgatan 143  
SE 105 45 Stockholm  
Sweden

FL3230204