

# Electrolux

## PURED9 Canister vacuum cleaner



**GB** INSTRUCTION BOOK  
**CS** 说明书  
**CT** 説明手冊

4 | **ID** BUKU PETUNJUK  
7 | **KO** 설명서  
10

13 | **TH** คู่มือการใช้งาน 19  
16 | **VI** SÁCH HƯỚNG DẪN 22

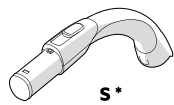
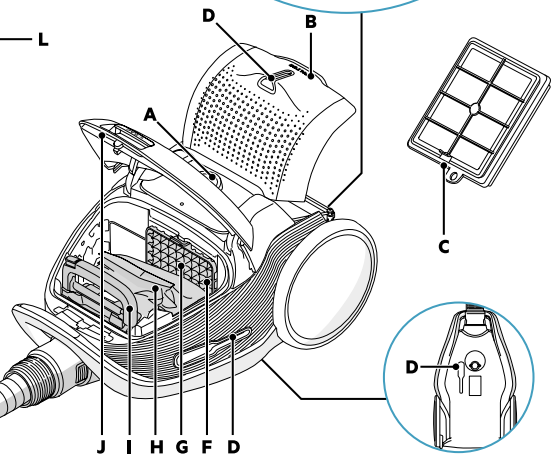
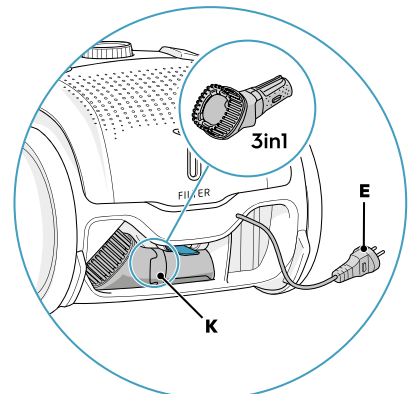
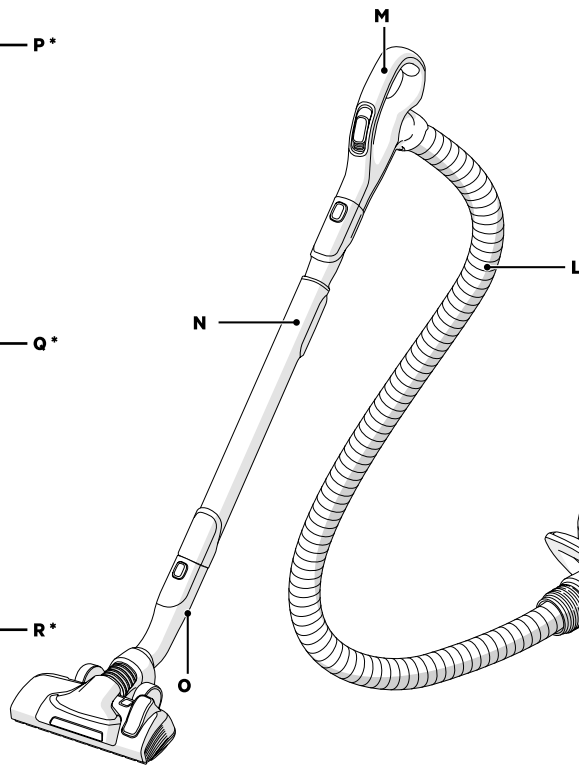
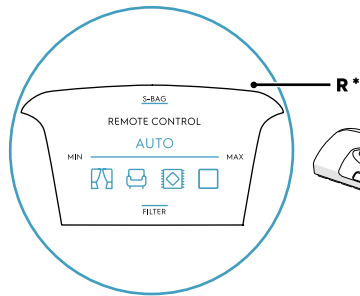
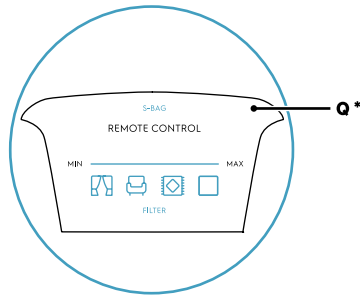
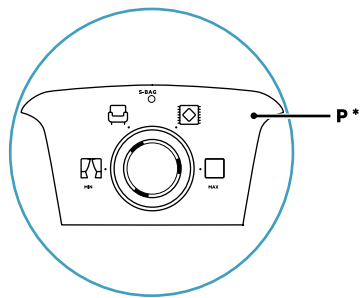

S\*

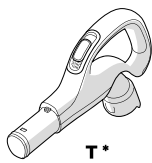

T\*

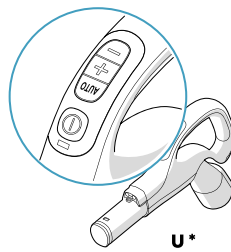

U\*

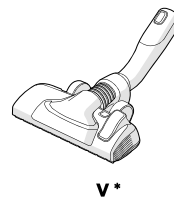

V\*

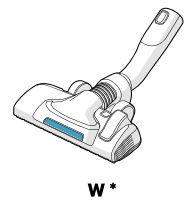

W\*

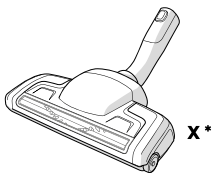

X\*



Y\*

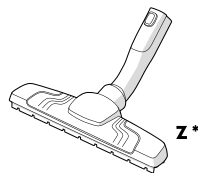

Z\*

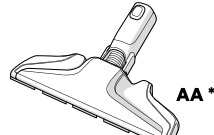

AA\*

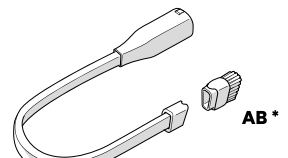

AB\*

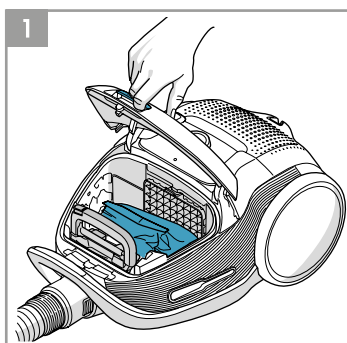

1

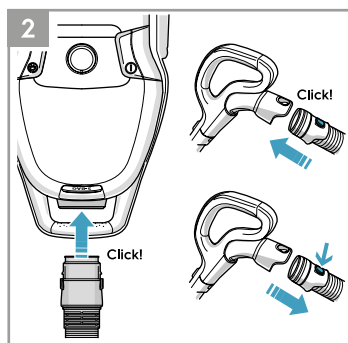

2

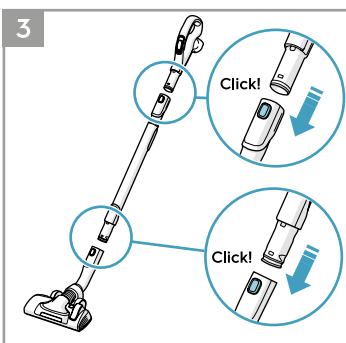

3

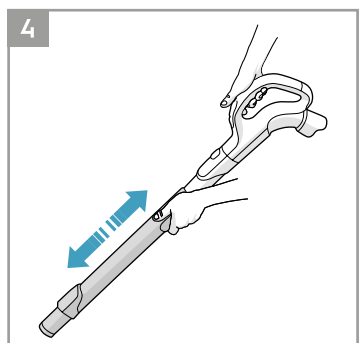

4

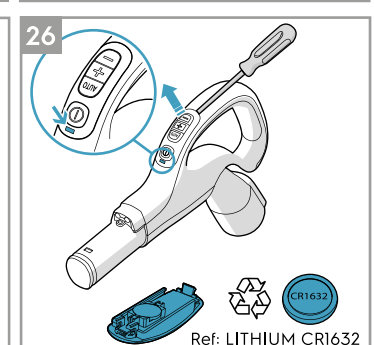
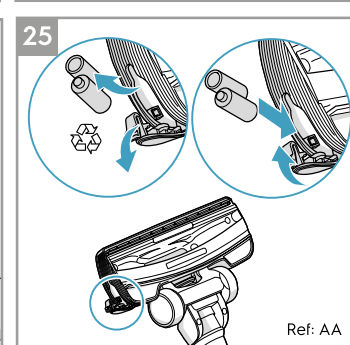
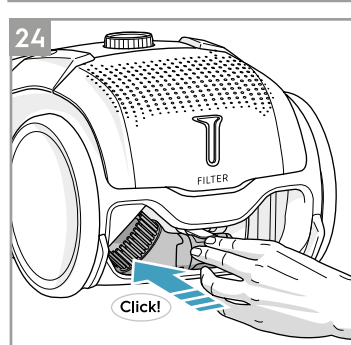
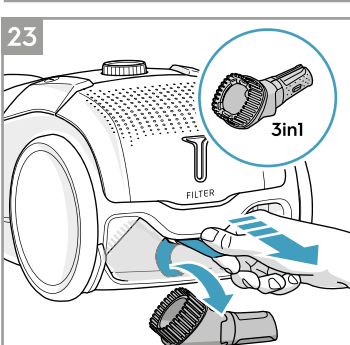
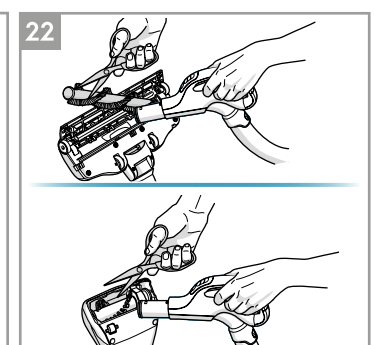
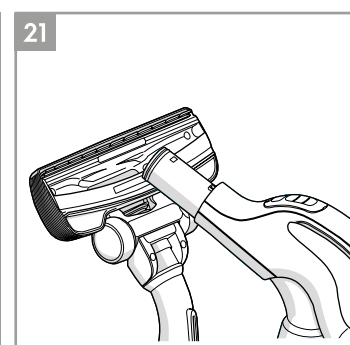
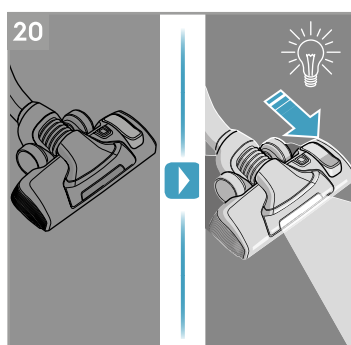
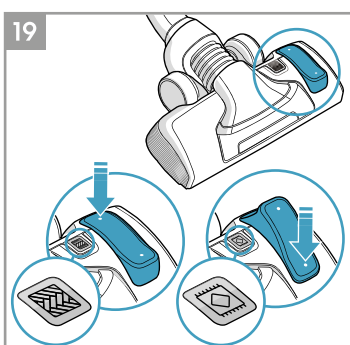
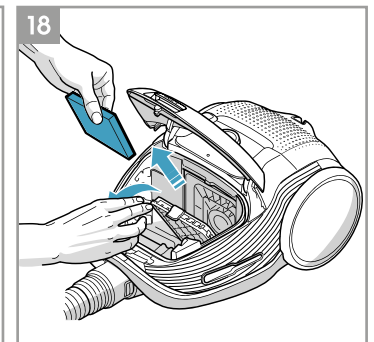
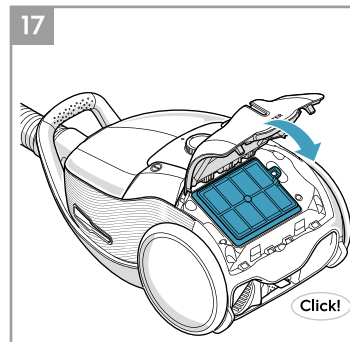
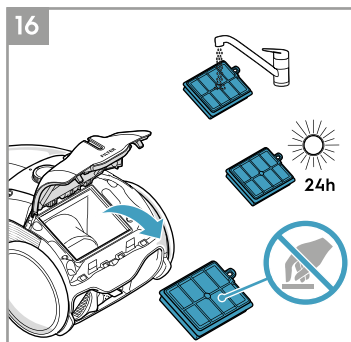
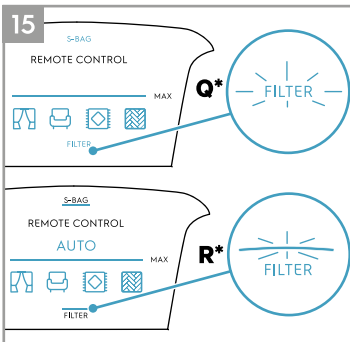
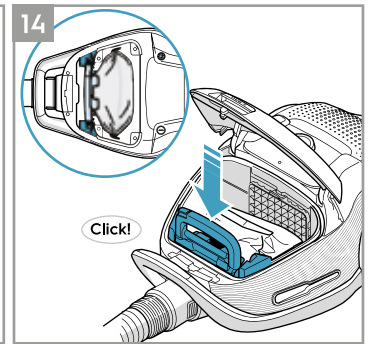
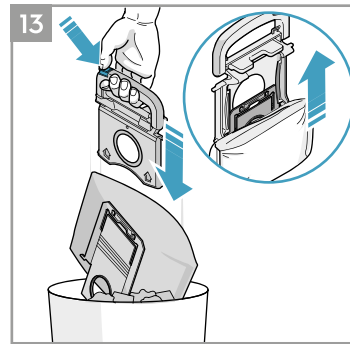
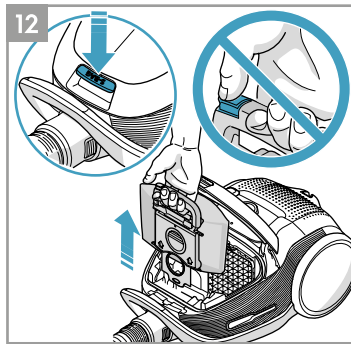
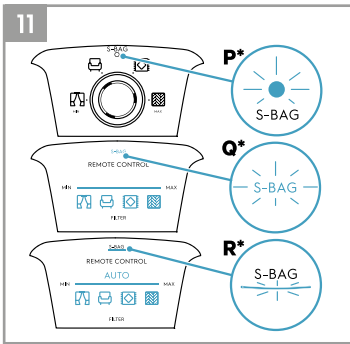
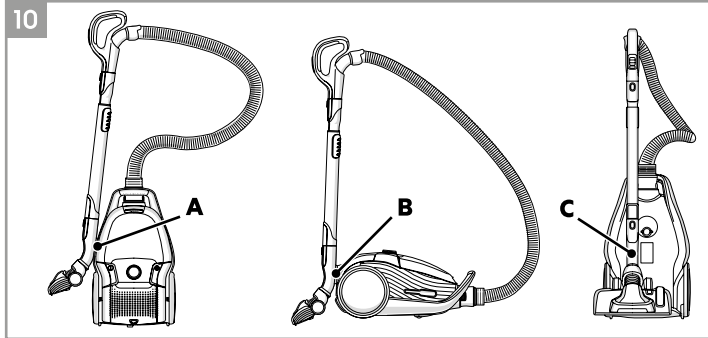
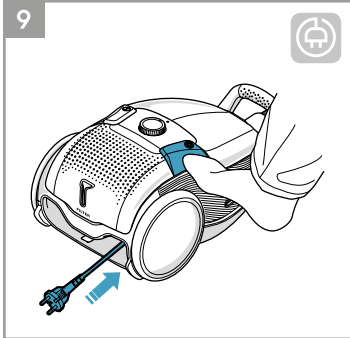
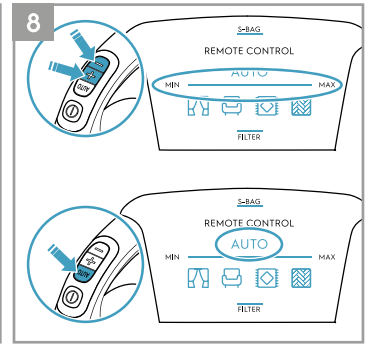
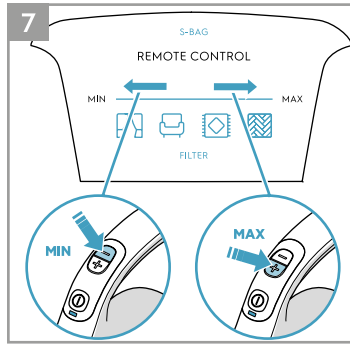
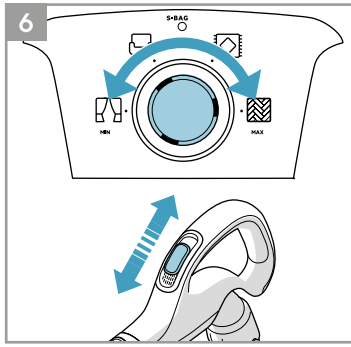
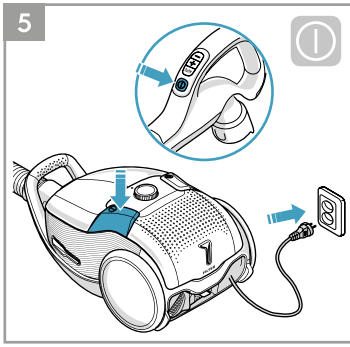

## ENGLISH

Thank you for choosing Electrolux PURED9 vacuum cleaner. Always use original accessories and spare parts to get the best results. This product is designed with the environment in mind. All plastic parts are marked for recycling purposes.

### BEFORE STARTING

- Read this manual carefully.
- Check that all parts described are included.
- Pay special attention to the safety precautions!

### DESCRIPTION OF PURED9 VACUUM CLEANER

A. Display (see versions later)	Q. Display for models with remote control*
B. Exhaust filter lid	R. Display for models with remote control and AUTO function*
C. Exhaust filter	S. AeroPro Classic handle*
D. Parking slots	T. AeroPro Ergo handle*
E. Power cord	U. AeroPro Remote Control handle*
F. Motor filter	V. AeroPro FlowMotion nozzle*
G. Motor filter holder	W. AeroPro FlowMotion LED (high) nozzle (with front lights)*
H. S-bag®	X. AeroPro Turbo nozzle*
I. S-bag® holder	Y. AeroPro Mini Turbo nozzle*
J. Dust compartment cover	Z. ParkettoPro nozzle*
K. AeroPro 3in1 tool	AA. AeroPro FlexProPlus nozzle*
L. AeroPro hose	AB. AeroPro Long crevice nozzle*
M. AeroPro handle (see versions later)	
N. AeroPro telescopic tube	
O. Parking clip	
P. Display for models with rotary knob manual control*	* Certain models only

### HOW TO USE THE VACUUM CLEANER

- 1 Open the dust compartment cover by pulling the S-BAG button. Check that the dust bag (s-bag) is in place.
- 2 Insert the hose into the cleaner (to remove it, press the lock buttons and pull). Insert the hose into the hose handle until the lock button clicks (to release it, press the lock button and pull).
- 3 Attach the telescopic tube to the nozzle. Attach the telescopic tube to the hose handle (to remove it, press the lock button and pull).
- 4 Adjust the telescopic tube by holding the lock with one hand and pulling the handle with the other hand.

### START/STOP THE VACUUM CLEANER AND ADJUST SUCTION POWER

- 5 Pull out the power cord and plug it into the mains. Press the ON/OFF button to turn the cleaner on/off. Indicators light up, MIN/MAX indicator lights up from left to right and back (auto function models).\* Models with remote control can also be operated by the ON/OFF button on the handle.\*
- 6 Adjust suction power (manual control models): Turn the rotary knob on the cleaner or use the air valve on the handle.\*
- 7 Adjust suction power (remote control models): Press +/- button on the handle. MIN/MAX and symbols indicators on display will show level of power.\*
- 8 Adjust suction power (remote control models with AUTO): The cleaner starts in AUTO mode (automatic power regulation). AUTO indicator is illuminated on the display and MIN/MAX indicator pulses. To regulate power manually press +/- button on handle. Press AUTO button to return to auto-function.\*
- 9 After cleaning, push the REWIND button to rewind the cable.

### PARKING POSITIONS

- 10 Use parking position on the side (A) or underneath (C) to carry and store the cleaner, or at the back when you want to pause cleaning.

### REPLACING THE DUSTBAG, S-BAG®

- 11 Replace the s-bag when
  - **P\* Models with rotary knob:** S-BAG indicator lights up in red
  - **Q\* Models with remote control:** S-BAG symbol lights up red.
  - **R\* Models with remote control and AUTO:** S-BAG indicator lights up in red (green light: bag is OK, yellow light: soon time to replace bag).

NB: Always change the s-bag when S-BAG indicator is illuminated or

has red light even if the s-bag is not full (it may be blocked) and after using carpet cleaning powder. For best possible performance, use the Ultra Long Performance bag which is especially developed for your cleaner. Other synthetic s-bags can also be used. Do not use paper dust bags! [www.s-bag.com](http://www.s-bag.com)

- 12 Pull the S-BAG button to open the dust compartment. The handle of the s-bag holder goes up. Pull the handle to remove the s-bag with holder. Do not press the release button.
- 13 Hold the s-bag with holder over a dust bin. Press the button to release the s-bag. Insert a new s-bag to the holder by inserting the cardboard/plastic at the back of the holder.
- 14 Insert the s-bag with holder by pushing it straight down in its tracks. Make sure the s-bag is not stuck under the holder. Close the lid. If the s-bag is not properly placed or is missing, the lid will not close.  
NB: When you start the cleaner after s-bag replacement, It takes 10 seconds before the S-BAG indicator turns off (P\* Models with rotary knob and Q\* Models with remote control) or turns green (R\* Models with remote control and AUTO).

### REPLACING THE FILTERS

- 15 Replace/clean\*\* the filter when (\*\*washable filter only)
  - **P\* Models with rotary knob:** you have changed the s-bag 5 times
  - **Q\* Models with remote control:** FILTER symbol lights up in red
  - **R\* Models with remote control and AUTO:** filter indicator lights up in red. Green light indicates that the filter is ok. It lights up briefly when you start the vacuum cleaner.
- 16 Pull the FILTER button to open the filter lid. Use original s-filters. Remove the filter and check the reference on the frame to define type. Replace with a new filter or clean it\*\*. Rinse the inside (dirty side) in lukewarm tap water. Tap the filter frame to remove the water. Repeat the process four times. (\*\*washable filter only)  
NB: Do not use cleaning agents. Avoid touching the filter surface. Let the filter dry completely (min. 24 h in room temperature) before putting back! Change the washable filter at least once a year or when it is very dirty or damaged. Do not remove the L-shaped foam under the filter.
- 17 After replacing the filter, close the filter lid until it is clicked back into place. If the filter lid comes off, position the hinges at the bottom and push the filter lid until it is clicked back into place.  
NB: When you start the cleaner after filter replacement, It takes 10 seconds before the FILTER indicator turns green (models with remote control and AUTO function) or turns off (remote control models).\*
- 18 Replace the motor filter when dirty or after every 5th s-bag. Push the filter holder down and pull it out. Exchange the filter and close the lid.

### VACUUMING WITH THE UNIVERSAL NOZZLE (V\*, W\*)

- 19 Change nozzle setting with the pedal. Icon illustrates recommended floor type.
- 20 FlowMotion LED (high) nozzle\*: Move the nozzle forward. The front light turns on automatically after a few seconds. When the nozzle is not used, the light turns off automatically after a few seconds.

### CLEANING THE UNIVERSAL NOZZLE (V\*, W\*\*)

- 21 Disconnect the nozzle from the tube. Clean with the hose handle.

### CLEANING THE TURBO NOZZLE (X\*)

- 22 Disconnect the nozzle from the tube and remove entangled threads etc by snipping them away with scissors. Use the hose handle to clean the nozzle.\*

### 3IN1 ACCESSORY TOOL

- 23 Pull the textile tab to take out 3in1 tool. The tool has 3 functions, see pictures on next page.
- 24 After usage, put it back in its place.





**CHANGING THE BATTERIES\***

- 25** Nozzle with front lights\*: Change batteries when front lights start blinking fast. Use 2 AA batteries.
- 26** Handle with remote control\*: Change battery when light indicator turns red or is not responding when pressing any button. Use only batteries type LITHIUM CR1632.
- NB: Remove the batteries from the product before scrapping. Follow your country's rules for collection of batteries and electrical products.

**Enjoy a great cleaning experience with PURED9!**

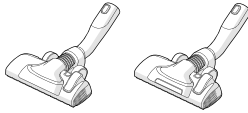
Electrolux reserves the right to change products, information and specifications without notice.

**TIPS ON HOW TO GET THE BEST RESULTS**

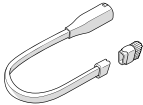
NOZZLE/ACCESSORY	USE FOR:	NOZZLE/ACCESSORY	USE FOR:
<b>K. 3in1 accessory tool*</b> 	<b>3 tools in 1:</b> 1. Dusting tool for hard surfaces (bookshelves, skirting boards etc). 2. Upholstery tool for textiles (curtains, upholstery etc). 3. Crevice tool for narrow spaces (behind radiators etc).	<b>V. FlowMotion nozzle*</b> <b>W. FlowMotion LED (high) nozzle (with front lights)*</b> 	<b>Universal nozzle:</b> - For all floor types, best dust pick up on both carpets and hard floors. - Change nozzle setting with the pedal. Icon will show recommended floor type. - Front light helps to detect dust and dirt in dark spaces (under furniture etc). <i>FlowMotion LED (high) nozzle only</i>
<b>X. Turbo nozzle*</b> 	<b>Carpet nozzle:</b> - Brushes and vacuums at the same time (best pick up of hair, fibres etc). - Brush roller is driven by the airflow of the vacuum cleaner. - Not suitable for carpets with very deep piles and long fringes, anti-slip carpets like door mats or water resistant carpets. Use universal nozzle instead.	<b>Y. Mini Turbo nozzle*</b> 	<b>Upholstery nozzle:</b> - Brushes and vacuums at the same time (best pick up of hair, fibres etc). - For textile furniture, car seats, mattresses etc. - Brush roller is driven by the airflow of the vacuum cleaner. - Not suitable for carpets with very deep pile and long fringes as it can get stuck in the rotating brush roll.
<b>Z. ParkettoPro nozzle*</b> 	<b>Hard floor nozzle:</b> - For gentle cleaning of hard floor (parquet, wooden floor, tiles etc). - Best dust pick up on hard floor with crevices.	<b>AA. FlexProPlus nozzle*</b> 	<b>Hardfloor nozzle:</b> - For reach under/between furniture, corners and other obstacles. - Can easily turn 180 degrees to access narrow spaces.
<b>AB. Long crevice nozzle*</b> 	<b>Extra long tool:</b> - For areas hard to reach (top of shelves etc). - For narrow spaces (behind radiators, under car seats etc).		

**Models with manual power regulation**  
 – follow graphics on cleaner for optimal performance.

**Models with AUTO-function automatically adjust the suction power**  
 in order to give an optimal cleaning performance and comfort on every surface. For manual regulation, follow graphics for optimal performance.

**TROUBLESHOOTING**

PROBLEM	SOLUTION
The vacuum cleaner does not start	<ul style="list-style-type: none"> <li>• Check that the cable is connected to the mains.</li> <li>• Check that the plug and cable are not damaged.</li> <li>• Check for a blown fuse.</li> <li>• Check if the battery indicator lamp in the remote control handle responds (certain models only).</li> </ul>
The s-bag® indicator light is illuminated	<ul style="list-style-type: none"> <li>• Check if the s-bag® is full or blocked.</li> <li>• If you have already changed the s-bag®, change the motor filter.</li> </ul>
The filter indicator light is illuminated (only at specific models)	Change, or wash (if washable), the exhaust filter.
The cleaner stops	The cleaner might be overheated: disconnect it from the mains; check if the nozzle, tube, hose or filters are blocked. Let the cleaner cool down for 30 minutes before plugging it in again. If the cleaner still does not work, contact an authorized Electrolux service centre.
Reduction of suction capacity versus normal	<ul style="list-style-type: none"> <li>• Check if the s-bag is full or blocked.</li> <li>• Check if the motor filter is clogged and needs changing.</li> <li>• Check if nozzle is blocked and needs to be cleared.</li> <li>• Check if hose is blocked by squeezing it gently. However, be careful in case the obstruction has been caused by glass or needles caught inside the hose.</li> </ul> Note: The warranty does not cover any damage to the hose caused by cleaning it.
Water has been sucked into the vacuum cleaner	It will be necessary to replace the motor at an authorized Electrolux service centre. Damage to the motor caused by the penetration of water is not covered by the warranty.

**For any further problems, contact an authorized Electrolux service centre.**

## SAFETY PRECAUTIONS

This appliance can be used by children aged from 8 years and above and persons with reduced physical, sensory or mental capabilities or lack of experience and knowledge if they have been given supervision or instruction concerning use of the appliance in a safe way and understand the hazards involved.

Children should not play with the appliance.

Cleaning and maintenance should not be undertaken by children without supervision.

**WARNING:** Turbo nozzles\* have a rotating brush where parts can get entrapped. Please use them with caution and only on intended surfaces. Please turn the vacuum cleaner off before removing entrapped parts or cleaning the brush.

Batteries must be removed from the remote control in the handle\* / LED lighted nozzle\* before scraping the product\*\*.

\*Certain models only.

\*\*Information on how to remove the battery in the fold-out part section 25 and 26.

Always disconnect the plug from the mains before cleaning or maintaining the appliance or when removing the battery. The battery is to be disposed of safely.

If the cord is damaged, it must be replaced only by an authorized Electrolux service centre in order to avoid a hazard.

PURED9 should only be used indoors for normal vacuuming and in a domestic environment. Make sure the vacuum cleaner is stored in a dry place.

All service or repairs must be carried out by an authorized Electrolux service centre.

Packaging material, e.g. plastic bags should not be accessible to children to avoid suffocation.

### Never use the vacuum cleaner:

In wet areas.

Close to flammable gases, etc.

When the product shows visible signs of damage.

On sharp objects or fluids.

When the floor nozzle shows visible signs of a damages.

On hot or cold cinders, lighted cigarette butts, etc.

On fine dust, for instance plaster, concrete, flour, hot or cold ashes.

Do not leave the vacuum cleaner in direct sunlight.

Avoid exposing the vacuum cleaner to strong heat or freezing temperatures.

Never use the vacuum cleaner without its filters.

Do not try to touch the brush roll while the cleaner is switched on and the brush roll is turning.

When the wheels are blocked.

### Power cord precautions

Check the plug and cord regularly. Never use the vacuum cleaner if the plug or cord is damaged.

Damage to the vacuum cleaner's cord is not covered by the warranty.

Never pull or lift the vacuum cleaner by the cord.

Using the vacuum cleaner in the above circumstances may cause serious personal injury or damage to the product. Such injury or damage is not covered by the warranty or by Electrolux.

### SERVICING AND WARRANTY

All service or repairs must be carried out by an authorized Electrolux service centre.

Damage to the vacuum cleaner's cord is not covered by the warranty.

Damage to the motor caused by; vacuuming liquid, immersing appliance in liquid or using appliance with a damaged hose and nozzle is not covered by the warranty.

Always use original s-bag dust bags suitable for this particular vacuum cleaner, see section 11. Damages caused to the cleaner by incorrect use of none-original dust bags is not covered by the warranty.

### DISPOSAL

This symbol on the product indicates that this product contains a battery which shall not be disposed with normal household waste.

This symbol on the product or on its packaging indicates that the product may not be treated as household waste.

To recycle your product, please take it to an official collection point or to an Electrolux service center that can remove and recycle the battery and electrical parts in a safe and professional way. Follow your country's rules for the separate collection of electrical products and rechargeable batteries.

Hereby, Electrolux Home Care and SDA, declares that the Vacuum Cleaner with radio equipment type HER2 and HER3 is in compliance with Directive 2014/53/EU.

### NOTES ON THE ENERGY LABEL REGULATIONS

This vacuum cleaner is a general purpose vacuum cleaner.

To achieve energy efficiency and the cleaning performance indicated for carpet, please use the interchangeable universal nozzle "FlowMotion / FlowMotion LED (high)".

To achieve the cleaning performance indicated for hard floor with crevices, please use the specific hard floor nozzle "Parketto Pro" when specified and included in the packaging, otherwise use the interchangeable universal nozzle "FlowMotion / FlowMotion LED (high)".

This instruction book, the cleaner specific fiche and energy label can be downloaded from our website, [www.electrolux.com](http://www.electrolux.com).

The calculations are based on the Commission Delegated Regulation (EU) No 665/2013 of 3rd May 2013 supplementing Directive 2010/30/EU. All of the procedures in these instructions that are not described in more precise detail were based on EN 60312-1:2013.

## 简体中文

非常感谢您选用Electrolux PURED9真空吸尘器。为保证理想使用效果，请始终使用原装配件和备件。本产品设计以环保为本。所有塑料部件均有回收标志。

### 使用前指南

- 仔细阅读本手册。
- 检查是否包括所有描述的部件。
- 应特别注意安全预防措施！

### PURED9真空吸尘器说明

- |                        |  |
|------------------------|--|
| A. 显示屏 (参见后面的版本)       | Q. 遥控型号专用显示屏*                                |
| B. 出风口滤网盖              | R. 具有遥控和自动功能的型号的专用显示屏*                       |
| C. 出风口滤网               | S. AeroPro Classic手柄*                        |
| D. 收纳卡槽                | T. AeroPro Ergo手柄*                           |
| E. 电源线                 | U. AeroPro遥控手柄*                              |
| F. 电机滤网                | V. AeroPro FlowMotion吸嘴*                     |
| G. 电机滤网架               | W. AeroPro FlowMotion LED (high) 吸嘴 (带有前灯) * |
| H. S-bag®              | X. AeroPro 涡轮吸嘴*                             |
| I. S-bag®支架            | Y. AeroPro微型涡轮吸嘴*                            |
| J. 集尘仓盖                | Z. ParkettoPro吸嘴*                            |
| K. AeroPro三合一工具        | AA. AeroPro FlexProPlus吸嘴*                   |
| L. AeroPro软管           | AB. AeroPro长缝隙吸嘴*                            |
| M. AeroPro手柄 (参见后面的版本) |  |
| N. AeroPro伸缩管          |  |
| O. 收纳夹                 | * 仅限特定型号                                     |
| P. 旋钮手动控制型号的专用显示屏*     |  |

### 如何使用真空吸尘器

- 1 拉动S-BAG按钮打开集尘仓盖。检查集尘袋 (s-bag) 是否安装到位。
- 2 将软管插入吸尘器 (要拔下，请按锁定按钮并拉动软管)。将软管插入软管手柄直到锁定按钮发出咔嚓声 (要拔下，请按锁定按钮并拉动软管)。
- 3 将伸缩管与吸嘴连接。将伸缩管连接到软管手柄 (要拔下，请按锁定按钮并拉动软管)。
- 4 用一只手按住锁定按钮，另一只手拉动手柄，即可调节伸缩管。

### 启动/停止真空吸尘器及调节吸力

- 5 拉出电源线，把它插到电源上。按下ON/OFF按钮以打开/关闭吸尘器。指示灯亮起，MIN/MAX指示灯从左到右然后从右到左亮起 (自动功能型号)。\*遥控型号也可通过手柄上的ON/OFF按钮操作。\*
- 6 调节吸力 (手动控制型号)：旋转吸尘器上的旋钮，或使用手柄上的空气阀。\*
- 7 调节吸力 (遥控型号)：按手柄上的+/-按钮。显示屏上的MIN/MAX和标志指示灯将显示功率水平。\*
- 8 调节吸力 (带有自动功能的遥控型号)：吸尘器以AUTO模式启动 (自动功率调节)。显示屏显示AUTO指示灯，MIN/MAX指示灯闪烁。要手动调节功率，请按手柄上的+/-按钮。按AUTO键返回自动功能。\*
- 9 清洁后，按下收线按钮，将电源线卷起。

### 收纳位置

- 10 将吸嘴插入侧面 (A) 或底部 (C) 的收纳位置来携带和存放吸尘器。清洁时如需暂停片刻，可使用后侧 (B) 的收纳位置。

### 更换集尘袋S-BAG®

- 11 请在下列情况更换s-bag
  - P\* 旋钮型号：S-BAG 指示灯亮起红灯
  - Q\* 遥控型号：S-BAG标志变为红色。
  - R\* 遥控和自动型号：S-BAG指示灯亮起红灯 (绿灯：尘袋良好，黄灯：即将需要更换尘袋)。
 注意：如果S-BAG 指示灯亮起或尽管s-bag未满但是红灯亮起 (可能被堵塞)，以及使用地毯去污粉后，请务必更换s-bag。要获得理想性能，请使用超长性能尘袋，它是专为您的吸尘器开发的。也可以使用其他的合成s-bag。请勿使用集尘纸袋！www.s-bag.com
- 12 拉动S-BAG按钮打开集尘仓。s-bag支架的手柄将向上移动。拉动手柄取下s-bag及支架。不要按下释放按钮。
- 13 将s-bag及支架举在垃圾桶上方。按下按钮释放s-bag。将硬板或塑料插入支架后面即可将新的s-bag插入支架。
- 14 将s-bag与支架一起沿导槽向下直推即可将其插入。确保s-bag没有卡在支架下面。盖上盖子。如果s-bag安放位置错误或丢失，盖子将无法关闭。
 

注意：如果在更换s-bag后开始清洁，则S-BAG指示灯需要10秒才会关闭 (P\* 旋钮型号和Q\* 遥控型号) 或变绿 (R\* 遥控和自动型号)。

### 更换滤网

- 15 请在下列情况更换/清洁\*\* 滤网 (\*\*仅限可清洗滤网)
  - P\* 旋钮型号：已经更换s-bag 5次
  - Q\* 遥控型号：滤网标志变成红色
  - R\* 遥控和自动型号：滤网指示灯变为红色。绿灯表示滤网正常。启动吸尘器时绿灯会短暂亮起。
- 16 拉动“FILTER”按钮打开滤网盖。使用原装滤网。拆下滤网并查看框架上的参考信息以确定型号。换上新的滤网或清洗原滤网\*\*。在温水中清洗内侧 (脏的一侧)。轻敲滤网框除去水分。重复进行四次。 (\*\*仅限可清洗滤网)
 

注意：请勿使用清洁剂。请勿触摸滤网表面。在滤网完全干燥 (常温下最少放置24小时) 后才可以装回！一年至少更换可清洗滤网一次，如果非常脏或发生损坏时也需要更换。请勿拆除滤网下的L型海绵。
- 17 更换滤网后，关闭滤网盖，直到它被按回原位并发出咔嚓声。如果滤网盖脱落，将底部的铰链放在正确位置上，按压滤网盖，直到它被按回原位并发出咔嚓声。
 

注意：更换滤网后启动吸尘器时，滤网指示灯需要10秒才会变成绿色 (遥控和自动型号) 或熄灭 (遥控型号)。\*
- 18 如果电机滤网变脏或每更换s-bag五次后，请更换电机滤网。向下按滤网架，将其拉出。更换滤网并合上盖子。

### 使用万能吸嘴 (V\*、W\*) 吸尘

- 19 使用踏板改变吸嘴设置。图标显示推荐的地面类型。
- 20 FlowMotion LED (high)吸嘴\*：将吸嘴向前推。几秒钟后前灯将自动打开。当不使用吸嘴时，前灯将在几秒钟后自动关闭。

### 清洁万能吸嘴 (V\*、W\*\*)

- 21 从管子上取下吸嘴。使用软管手柄进行清洁。

### 清洁涡轮吸嘴 (X\*)

- 22 从管子上取下吸嘴，然后用剪刀剪除缠绕的线头等。用软管手柄清洁吸嘴。\*

### 三合一配套工具

- 23 拉动物垂片取出三合一工具。该工具有3种功能，见下一页的图片。
- 24 使用后，请把它放回原处。





更换电池\*

- 25 带前灯吸嘴\*：前灯开始快速闪烁时请更换电池。使用2节AA电池。
- 26 具有遥控功能的手柄\*：当指示灯变为红色或按任何按钮均无反应时请更换电池。仅可使用CR1632型号锂电池。
- 注意：在丢弃之前从产品中取出电池。请遵守您所在国家/地区收集电池和电气产品的规定。

PURED9给您带来极佳清洁体验！

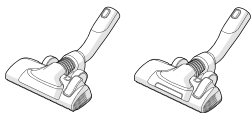
Electrolux保留更改产品、信息和规格的权利，恕不另行通知。

如何发挥理想效果的提示

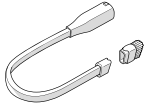
吸嘴/配件	用途：	吸嘴/配件	用途：
<b>K. 三合一配套工具*</b> 	<b>三合一工具：</b> 1. 适用于硬质表面（书架、踢脚板等）的除尘工具。 2. 适用于纺织品（窗帘、装饰等）的清洁工具。 3. 适用于狭窄空间（暖气后角落等）的缝隙清洁工具。	<b>V. FlowMotion吸嘴*</b> <b>W. FlowMotion LED (high)吸嘴 (带有前灯) *</b> 	<b>通用吸嘴：</b> - 适合所有地板类型，可以在地毯和硬地板上获得最理想的除尘效果。 - 使用踏板改变吸嘴设置。图标将显示建议的地板类型。 - 前灯有助于发现暗处（家具下方等位置）的灰尘和污垢。仅限 FlowMotion LED (high) 吸嘴
<b>X. 涡轮吸嘴*</b> 	<b>地毯吸嘴：</b> - 同时使用刷子和真空除尘（清除头发、纤维等的理想工具）。 - 辊刷由真空吸尘器的气流驱动。 - 不适合长绒和长毛边地毯以及门垫或防水地毯等防滑地毯。请使用通用吸嘴。	<b>Y. 微型涡轮吸嘴*</b> 	<b>饰品吸嘴：</b> - 同时使用刷子和真空除尘（清除头发、纤维等的理想工具）。 - 适合纺织家私、汽车座椅、床垫等。 - 辊刷由真空吸尘器的气流驱动。 - 不适合长绒和长毛边地毯，因为它可能卡在旋转的辊刷上。
<b>Z. ParkettoPro吸嘴*</b> 	<b>硬地板吸嘴：</b> - 对硬地板（拼花地板、木地板、瓷砖等）进行柔和清洁。 - 非常适合为带有缝隙的硬地板除尘。	<b>AA. FlexProPlus吸嘴*</b> 	<b>硬地板吸嘴：</b> - 可以清洁家具、转角和其他障碍物下方或之间的灰尘。 - 可以轻松转动180度，伸入狭窄空间。
<b>AB. 长缝隙吸嘴*</b> 	<b>加长工具：</b> - 用于清洁很难够到的地方（置物架顶部等）。 - 适合狭窄空间（暖气后面、汽车座椅下方等区域）。		

手动功率调节型号  
- 按照吸尘器上的图片操作以达到理想性能。

具备自动功能的型号可以自动调节吸力，从而在任何表面都可以提供理想的清洁性能和舒适性。要进行手动调节，请遵循图片操作获得理想性能。

故障排除

问题	解决方法
真空吸尘器无法启动	<ul style="list-style-type: none"> <li>检查电缆是否已连接电源。</li> <li>检查插头与电源线是否受损。</li> <li>检查保险丝。</li> <li>检查遥控手柄上的电池指示灯是否响应（只针对某些型号）。</li> </ul>
s-bag®指示灯亮起	<ul style="list-style-type: none"> <li>检查s-bag®是否已满或是否被阻塞。</li> <li>如果您已经更换了s-bag®, 请更换电机滤网。</li> </ul>
滤网指示灯亮起（只适用于特定型号）	更换或清洗（如果可以清洗）出风口滤网。
吸尘器停止工作	吸尘器可能过热：断开电源；检查吸嘴、管子、软管或滤网是否堵塞。让吸尘器冷却30分钟后再插入电源。如果吸尘器仍然无法正常工作，请联系授权的Electrolux服务中心。
吸力低于正常吸力	<ul style="list-style-type: none"> <li>检查s-bag®是否已满或是否被阻塞。</li> <li>检查电机滤网是否堵塞及需要更换。</li> <li>检查吸嘴是否堵塞及需要清洁。</li> <li>轻轻挤压软管，检查是否被堵塞。但是，当玻璃或针卡在软管中造成阻塞时要小心处理。</li> </ul> 注意：清洗所引起的软管损坏不属于保修范围。
吸尘器内部进水	请务必在授权的Electrolux服务中心更换电机。由进水引起的电机损坏不在保修范围之列。
任何其他问题，请联系Electrolux授权服务中心。	

## 安全注意事项

对于8岁及以上的儿童和存在身体、感觉或精神障碍以及缺乏相关经验和知识的人士，在得到有关安全使用的监督或指导并能理解相关危害的情况下，才可以使用设备。

儿童不能玩弄器具，也不能当玩具使用。

儿童不应在没有监管的情况下清洁和维护本产品。

**警告：**涡轮吸嘴\*带有一个旋转的刷子，零件可能会卡住。请只在适合的表面小心使用这些吸嘴。请在拆卸卡住的零件或清洗刷子之前关闭真空吸尘器。

在丢弃产品\*\*之前，必须从手柄的遥控器\*/LED照明吸嘴\*上拆下电池。

\***仅限特定型号。**

\*\***折叠插页剖视图25和26中包含如何移除电池的信息。**

在清洁或保养设备或拆卸电池前，务必先断开电源插头。电池应安全处理。

如果电源线损坏，则必须由授权Electrolux服务中心进行替换，以免发生危险。

PURED9只能用于室内和家庭环境中的正常吸尘用途。确保真空吸尘器存放在干燥的地方。  
所有维护或修理必须由授权的 Electrolux 服务中心提供。  
所有包装材料（如塑料袋）应置于儿童接触不到的地方，以防窒息。

切勿在下列情况使用真空吸尘器：

潮湿的地方。  
接近易燃气体等。  
产品出现明显的损坏迹象。  
存在尖锐物体或液体。  
地板吸嘴出现明显的损坏迹象时。  
存在热或冷的灰烬、点燃的烟头等  
存在细粉尘，例如石膏、水泥、面粉、热或冷的灰烬。  
请勿将真空吸尘器置于阳光直射的地方。  
避免将真空吸尘器暴露在强热或冰点温度中。  
切勿使用没有安装滤网的真空吸尘器。  
在吸尘器打开且辊刷转动时，切勿尝试触摸辊刷。  
当轮子被阻塞时。

电源线的预防措施

定期检查插头和电源线。如果插头或电源线受损，切勿使用该真空吸尘器。  
真空吸尘器的电源线损坏不在保修范围之内。  
切勿用电源线拉扯或抬高真空吸尘器。  
在上述情况下使用吸尘器可能会导致严重的人身伤害或产品损坏。此类损伤或损坏均不在保修范围内或由Electrolux承担责任。

服务和保修

所有维护或修理必须由授权的Electrolux服务中心提供。  
真空吸尘器的电源线损坏不在保修范围之内。真空吸入液体、设备浸入液体或设备的软管和吸嘴已损坏而引致的电机损坏不在保修范围内。  
始终使用适合这一真空吸尘器的s-bag集尘袋，见第11节。错误使用非原装集尘袋而导致吸尘器受损不在保修范围内。

弃置

产品上的此符号表示本产品包含电池，不得与普通生活垃圾一起处理。

产品或包装上的此符号表示该产品不能作为家庭废弃物来弃置。

要回收您的产品，请将其送至官方收集点或Electrolux服务中心，以便以安全和专业的方式移除和回收电池和电气部件。按照您所在国家的规定，单独收集电气产品和可充电电池。

Electrolux Home Care and SDA特此声明，带有HER2和HER3型无线设备的真空吸尘器符合2014/53/EU法令。

能源标签规定的说明

此真空吸尘器是一种通用真空吸尘器。  
如要在清洁地毯时达到标明的能源效率和清洁性能，请使用可互换通用吸嘴“FlowMotion/FlowMotion LED (high)”。  
如要在清洁带有缝隙的硬地板时达到标明的清洁性能，并且如果在包装中说明并提供了专用硬地板吸嘴“Parketto Pro”，请使用此吸嘴，否则使用可互换的通用吸嘴“FlowMotion / FlowMotion LED (high)”。  
可以从我们的网站www.electrolux.com下载本说明书、吸尘器专用规格卡以及能效标识。  
这些计算基于2010/30/EU指令的委员会委托监管条例（欧盟）2013年5月3日第665/2013号补充条款。这些在说明书中没有详细描述的所有步骤均基于EN 60312-1:2013。

## 繁體中文

感謝您選用伊萊克斯 PURED9 吸塵器。為確保獲得最佳使用效果，請一律使用原廠配件及零件。本產品以環保概念為設計理念。所有塑膠零件均標有回收標誌。

### 使用前

- 請仔細閱讀本手冊。
- 確保所述所有零件均已包含在內。
- 請特別注意安全預防措施！

### PURED9 吸塵器說明

- |                                 |   |
|---------------------------------|---|
| A. 顯示器（各型號版本請參考項目 P、Q、R）        | Q. 顯示器（針對具備遙控功能的型號）*                        |
| B. 排氣濾網蓋                        | R. 顯示器（針對具備遙控以及自動功能的型號）*                    |
| C. 排氣濾網                         | S. AeroPro 經典把手*                            |
| D. 伸縮管收納槽                       | T. AeroPro Ergo 人體工學把手*                     |
| E. 電源線                          | U. AeroPro 遙控把手*                            |
| F. 馬達濾網                         | V. AeroPro FlowMotion 吸頭*                   |
| G. 馬達濾網固定座                      | W. AeroPro FlowMotion LED (high) 吸頭（配備前置燈）* |
| H. S-bag® 集塵袋                   | X. AeroPro 渦輪吸頭*                            |
| I. S-bag® 集塵袋固定座                | Y. AeroPro 迷你渦輪吸頭*                          |
| J. 集塵室蓋                         | Z. ParkettoPro 木質地板吸頭*                      |
| K. AeroPro 3 合 1 吸頭             | AA. AeroPro FlexProPlus 超扁平地板吸頭*            |
| L. AeroPro 軟管                   | AB. AeroPro 長細縫吸頭*                          |
| M. AeroPro 把手（各型號版本請參考項目 S、T、U） |   |
| N. AeroPro 伸縮管                  |   |
| O. 收納卡榫                         |   |
| P. 顯示器（針對具備旋鈕手動控制功能的型號）*        | * 僅特定型號                                     |

### 吸塵器使用說明

- 1 拉提 S-BAG 按扣以開啟集塵室蓋。檢查集塵袋 (s-bag) 是否安裝在正確位置。
- 2 將軟管插入吸塵器中（按下兩側按鈕並拉動軟管，即可鬆開並取出軟管）。將軟管插入軟管把手，直到鎖定按鈕發出卡嗒聲（按住鎖定按鈕並拉動，即可將其鬆開）。
- 3 將伸縮管接到吸頭。將伸縮管接到軟管把手（按住鎖定按鈕並拉動，即可將其取出）。
- 4 調整伸縮管，方法是一隻手按住鎖定按鈕，再用另一隻手拉動把手。

### 啟動/停止吸塵器並調整吸力

- 5 拉出電源線並將其連接到電源。按下機身上「ON/OFF」按鈕以啟動/關閉吸塵器。指示燈亮起，「MIN/MAX」（最小/最大）指示燈從左至右亮起並返回（具備自動功能的型號）。\* 具備遙控功能的吸塵器，也可以使用把手上的「ON/OFF」按鈕來操作。\*
- 6 調整吸力（具備手動控制功能的型號）：使用吸塵器上的旋鈕或把手上的洩氣閥。\*
- 7 調整吸力（具備遙控功能的型號）：按下把手上的 +/- 按鈕。顯示器上的「MIN/MAX」以及符號指示燈將顯示吸力等級。\*
- 8 調整吸力（具備自動功能的遙控型號）：吸塵器以「自動」（自動吸力調節）模式啟動。顯示器上的「AUTO」（自動）指示燈亮起，「MIN/MAX」指示燈閃爍。如需手動調節吸力，請按下把手上的 +/- 按鈕。按下「AUTO」按鈕可返回自動功能。\*
- 9 吸塵之後，按下機身上的「REWIND」（回捲）按鈕回捲電源線。

### 收納位置

- 10 使用側面 (A) 或底部 (C) 的收納卡榫，可拿取與存放吸塵器。清潔時如需暫停片刻，請使用背面的卡榫 (B)（您便無須俯身）。

### 更換集塵袋 S-BAG®

- 11 出現以下情形時請更換 s-bag 集塵袋：
  - **P\*** 配備旋鈕的型號：S-BAG 指示燈亮起紅燈
  - **Q\*** 具備遙控功能的型號：S-BAG 符號指示燈亮起紅燈。
  - **R\*** 具備遙控和自動功能的型號：S-BAG 指示燈亮起紅燈（綠燈：集塵袋正常，黃燈：即將要更換集塵袋）。注意：S-BAG 指示燈亮起或即使 s-bag 集塵袋未滿但發出紅光時（可能被阻塞），以及在使用地毯清潔粉之後，均務必要更換 s-bag 集塵袋。為獲得最佳使用效能，請使用專為您的吸塵器而研發設計的特長效集塵袋。亦可使用其他合成 s-bag 集塵袋。請勿使用紙質集塵袋！www.s-bag.com
- 12 拉提 S-BAG 按扣以開啟集塵室。s-bag 集塵袋固定座的把手會上升。拉動把手以同時取下 s-bag 集塵袋和固定座。不要按下釋放按鈕。
- 13 將 s-bag 集塵袋（隨固定座一起）放置於垃圾桶上方。按下釋放按鈕以鬆開 s-bag 集塵袋。在固定座背面插入紙板，以將新 s-bag 集塵袋插入固定座。
- 14 將 s-bag 集塵袋（隨固定座一起）直接向下推入其軌道，將其插入。確保 s-bag 集塵袋未卡在固定座下方。蓋上蓋子。如果 s-bag 集塵袋未正確放置或缺少 s-bag 集塵袋，則蓋子將無法合上。注意：更換 s-bag 集塵袋後再啟動吸塵器時，S-BAG 指示燈在 10 秒後才會熄滅（P\* 配備旋鈕的型號以及 Q\* 具備遙控功能的型號）或變綠（R\* 具備遙控和自動功能的型號）。

### 更換濾網

- 15 出現以下情形時請更換/清潔\*\*濾網（\*\*僅限可洗濾網）
  - **P\*** 配備旋鈕的型號：已更換 s-bag 集塵袋 5 次
  - **Q\*** 具備遙控功能的型號：「濾網」符號指示燈亮起紅燈
  - **R\*** 具備遙控和自動功能的型號：濾網指示燈亮起紅燈。綠燈表示濾網正常。啟動吸塵器時綠燈會短暫亮起。
- 16 拉提「FILTER」（濾網）按扣以開啟濾網蓋。使用原廠 s-濾網。取下濾網並查看外框上的參考資料以確定類型。更換新濾網或清潔該濾網\*\*。用常溫自來水沖洗內部（髒污的一側）。輕敲濾網外框以去除水分。重複此程序四次。（\*\*僅限可洗濾網）注意：請勿使用清潔劑。避免觸碰濾網表面。將濾網充分陰乾後（室溫下至少 24 小時），才可將其裝回！至少一年更換一次可洗濾網或者在濾網髒污程度比較高或受損後，也應予以更換。切勿取下濾網下的 L 型海綿。
- 17 更換濾網後，合上濾網蓋，直到其發出入位卡嗒聲。如果濾網蓋脫離，則定位底部的轉軸並推動濾網蓋，直至其發出入位卡嗒聲。注意：更換濾網後再啟動吸塵器時，「濾網」指示燈在 10 秒後才會變綠（具備遙控和自動功能的型號）或者熄滅（具備遙控功能的型號）。\*
- 18 馬達濾網變髒或每更換 5 次 s-bag 集塵袋後，請更換馬達濾網。向下推動濾網固定座並將其拉出。更換濾網並合上濾網蓋。

### 使用通用吸頭 (V\*、W\*) 吸塵

- 19 使用踏板變更吸頭設定。圖示顯示所建議的地板類型。
- 20 FlowMotion LED (high) 吸頭\*：向前移動吸頭。數秒後，前置燈將自動開啟。不使用吸頭時，前置燈會在數秒後自動熄滅。

### 清潔通用吸頭 (V\*、W\*\*)

- 21 斷開吸頭與伸縮管的連接。使用軟管把手進行清潔。

### 清潔渦輪吸頭 (X\*)

- 22 斷開吸頭與伸縮管的連接，並用剪刀將纏住的絲線等異物剪除。使用軟管把手清潔吸頭。\*

### 3 合 1 配件吸頭

- 23 拉動線纜，將 3 合 1 吸頭拉出。此工具具備 3 種功能，請參閱下頁的圖片。
- 24 使用後，請將其裝回原處。

**更換電池\***

**25** 配備前置燈的吸頭\*：前置燈開始快速閃爍時，請更換電池。使用 2 枚 AA 電池。



**26** 具備遙控功能的把手\*：指示燈變紅或在按下任何按鈕後均無反應時，請更換電池。請使用鋰電池 CR1632 這一電池類型。

注意：請先從產品中取下電池，再進行報廢處理。請遵循您所在國家的規範，來回收電池和電子產品。

請享受 **PURED9** 帶來的絕佳清潔體驗！

伊萊克斯保留隨時變更產品、資訊與規格之權利，恕不事先通知。

**獲致最佳清掃效果的技巧**

吸頭/配件	用途：	吸頭/配件	用途：
<b>K. 3 合 1 配件吸頭*</b> 	<b>3 合 1 吸頭：</b> 1. 用於硬質表面的除塵工具（書架、壁腳板等）。 2. 用於裝飾織物的清潔工具（窗簾、裝飾織物等）。 3. 用於狹窄空間的細縫清潔工具（散熱器後方等）。	<b>V. FlowMotion 吸頭*</b> <b>W. FlowMotion LED (high) 吸頭 (配備前置燈)*</b> 	<b>通用吸頭：</b> - 適用於所有地板類型，可在地毯和硬質地板上獲致最佳吸塵效果。 - 使用踏板變更吸頭設定。圖示將顯示建議的地板類型。 - 前置燈有助於發現暗區（傢俱下方等位置）的灰塵和污物。 <i>僅限 FlowMotion LED (high) 吸頭</i>
<b>X. 渦輪吸頭*</b> 	<b>地毯用吸頭：</b> - 同時進行拍打和吸塵（最適宜用於收集髮絲、纖維等）。 - 滾刷由吸塵器的氣流驅動。 - 不適用於含有長絨毛和長花邊的地毯，以及門墊或防水地毯等的防滑地毯。這種情況下請使用通用吸頭。	<b>Y. 迷你渦輪吸頭*</b> 	<b>裝飾織物用吸頭：</b> - 同時進行拍打和吸塵（最適宜用於收集髮絲、纖維等）。 - 適用於清掃傢俱裝飾織物、汽車座椅、床墊等。 - 滾刷由吸塵器的氣流驅動。 - 不適用於含有長絨毛和長花邊的地毯，因為滾刷旋轉時，地毯可能會卡入其中。
<b>Z. ParkettoPro 木質地板吸頭*</b> 	<b>硬質地板用吸頭：</b> - 適用於溫和清潔硬質地板（嵌木地板、木質地板、瓷磚等）。 - 可在硬質地板上獲得最佳的細縫除塵效果。	<b>AA. FlexProPlus 超扁平地板吸頭*</b> 	<b>硬質地板用吸頭：</b> - 適用於清潔傢俱下方/傢俱之間的位置、角落以及其他障礙物。 - 可輕鬆轉動 180 度，直接到達狹窄空間。
<b>AB. 長細縫吸頭*</b> 	<b>超長工具：</b> - 適用於難以到達的區域（書架頂部等）。 - 適用於狹窄空間（散熱器後方、汽車座椅下方等）。		

**具備手動吸力調節功能的型號**

- 遵循吸塵器上的圖示，以獲致最佳效能。

**具備自動功能的型號可自動調整吸力，**

以便在每種表面上均實現最佳清潔效能及舒適感。對於手動調節，請遵循圖示以獲致最佳效能。

**疑難排解**

問題	解決方法
吸塵器不啟動	<ul style="list-style-type: none"> <li>確定電源線已連接到電源。</li> <li>確認插頭和電源線並未損壞。</li> <li>檢查保險絲是否熔斷。</li> <li>檢查遙控把手的電池指示燈是否有回應（僅限特定型號）。</li> </ul>
s-bag® 指示燈已亮起	<ul style="list-style-type: none"> <li>檢查 s-bag® 集塵袋是否已滿或阻塞。</li> <li>如果您已經更換 s-bag® 集塵袋，請更換馬達濾網。</li> </ul>
濾網指示燈亮起（僅限於特定型號）	<ul style="list-style-type: none"> <li>更換或清洗（若可洗）排氣濾網。</li> </ul>
吸塵器停止運作	<ul style="list-style-type: none"> <li>吸塵器可能溫度過高：中斷與電源的連接；檢查吸頭、伸縮管、軟管或濾網是否阻塞。讓吸塵器冷卻 30 分鐘，然後再重新連接電源。</li> <li>如果吸塵器仍然無法運作，請聯絡伊萊克斯客戶服務中心。</li> </ul>
吸力低於正常水平	<ul style="list-style-type: none"> <li>檢查 s-bag 集塵袋是否已滿或阻塞。</li> <li>檢查馬達濾網是否已阻塞並需要更換。</li> <li>檢查吸頭是否已阻塞並需要清潔。</li> <li>輕柔擠壓軟管，以確認其是否已阻塞。然而，如果是因為軟管內部的玻璃或針狀物造成阻塞，請務必小心處理。</li> <li>注意：因清潔而導致軟管受損並未在保固範圍內。</li> </ul>
吸塵器吸入水	<ul style="list-style-type: none"> <li>必須至伊萊克斯客戶服務中心更換馬達。</li> <li>因水滲入造成馬達損壞並未在保固範圍內。</li> </ul>
如有任何其他問題，請聯絡伊萊克斯客戶服務中心。	

## 安全預防措施

本機設計不適合 8 歲以下兒童、體格、感官或精神能力不健全，或者是缺少經驗和知識的人士使用，除非他們已透過負責他們安全的人士獲得有關使用本機的監督或說明。

請不要讓兒童把玩本機。

若無人監督，不可由兒童執行清潔與保養。

**警告：**渦輪吸頭\*採用可能會將零件卡入其中的旋轉式毛刷。請小心使用此吸頭，而且只能用於指定表面。在取下卡住的零件或清潔毛刷前，請先關閉吸塵器的電源。

必須先從具備遙控功能的把手\* / 配備 LED 指示燈的吸頭\*中取下電池，再將產品報廢\*\*。

\*僅特定型號。

\*\*有關如何取下電池的資訊，請參閱折頁第 25 和第 26 小節。

清潔或保養本機前或者取下電池前，務必先斷開插頭與電源的連接。電池應以安全的方式棄置。

如果電源線損壞，則必須由伊萊克斯客戶服務中心予以更換，以避免發生危險。

PURE D9 僅適用於室內及居家環境的一般清掃。請確保吸塵器存放在乾爽的地方。

所有的服務或維修皆必須由伊萊克斯客戶服務中心執行。包裝物料（例如塑膠袋）皆不應放置在兒童可接觸到的地方，以免導致窒息。

在以下情形中，請勿使用吸塵器：

- 潮濕的地方。
- 在易燃氣體等附近。
- 產品出現明顯損壞跡象時。
- 在尖銳的物品或液體上。
- 地板吸頭出現明顯損壞跡象時。
- 熱或冷的灰燼、點燃的菸頭上等。
- 在石膏、混凝土、麵粉、熱或冷灰燼等微細粉塵上。
- 請勿讓吸塵器受到日光直射。
- 請避免吸塵器承受高熱或凍溫。
- 請勿在未安裝濾網的情況下使用吸塵器。
- 若吸塵器已啟動且滾刷正在轉動，請勿嘗試觸碰滾刷。
- 輪子阻塞時。

### 電源線預防措施

定期檢查插頭及電源線。切勿使用插頭或電源線受損的吸塵器。吸塵器電源線的損壞不在保固範圍內。切勿利用電源線拉扯或抬高吸塵器。於上述情況下使用吸塵器可能導致嚴重人身傷害或產品損壞。本機的保固或伊萊克斯公司對此等傷害或損壞不予負責。

### 維修與保固

所有服務或維修皆必須由伊萊克斯客戶服務中心執行。吸塵器電源線的損壞不在保固範圍內。由於以下原因造成的馬達損壞皆不在保固範圍內：清掃液體、將本機浸入液體中或者在軟管和吸頭受損的情況下使用本機。務必使用適用於本特定吸塵器的原裝 s-bag 集塵袋，具體資訊請參閱第 11 小節。因不當使用非原廠集塵袋而導致的吸塵器受損並不在保固範圍內。

### 廢棄處理

產品上的  這個標記表示產品包含電池，而電池不應隨一般家庭垃圾棄置。

產品或其包裝上的  這個標記表示不能將產品視為家庭垃圾進行處理。

若要回收產品，請將其送到正式回收站點或伊萊克斯客戶服務中心，這些地方能夠以安全、專業的方式來移除和回收電池與電器零件。請遵循您所在國家的規範，分別回收電器產品和可充電電池。

Electrolux Home Care 和 SDA 在此聲明，本款吸塵器（配備 HER2 和 HER3 類型無線電設備）符合指令 2014/53/EU。

### 客戶服務

有鑒於世界各國對綠色環保意識的重視，伊萊克斯依循 RoHS 「危害性限制物質指令」誠實標示產品化學物質含量，關於本產品的 RoHS 聲明書，請上伊萊克斯官網 --> 「支援服務」--> 「RoHS 聲明書」，依產品類別及型號檢索。  
<http://www.electrolux.com.tw/Support/Customer-Care/>

### 有關能源標籤規範的說明

本款吸塵器屬通用型吸塵器。  
為實現最高的能源效率以及所述之地毯清潔效能，請使用可切換清潔模式的通用吸頭「FlowMotion / FlowMotion LED (high)」。  
為實現所述硬質地板（含細縫）清潔效能，請使用特定的硬質地板專用吸頭「Parketto Pro」（特定型號之內附吸頭），若該型號無內附此吸頭時，請使用可切換清潔模式的通用吸頭「FlowMotion / FlowMotion LED (high)」。  
您可透過我們網站 [www.electrolux.com](http://www.electrolux.com) 下載本說明手冊、吸塵器規格書以及能源標籤。  
能源效率之計算以歐盟委員會委派條例第 665/2013 號（於 2013 年 5 月 3 日頒發，作為對指令 2010/30/EU 的補充）為基礎。本說明手冊中未詳盡描述的所有程序，均以 EN 60312-1:2013 為基礎。

## BAHASA INDONESIA

Terima kasih telah memilih pengisap debu Electrolux PURED9. Selalu gunakan aksesoris dan suku cadang asli untuk mendapatkan hasil terbaik. Produk ini dirancang dengan mempertimbangkan lingkungan hidup. Semua komponen plastik ditandai untuk tujuan daur ulang.

### SEBELUM MEMULAI

- Baca buku petunjuk ini dengan saksama.
- Pastikan bahwa semua komponen yang diuraikan ada di dalam kemasan.
- Perhatikan baik-baik langkah pencegahan untuk keselamatan.

### DESKRIPSI PENGISAP DEBU PURED9

- |  |  |
|--|--|
| A. Tampilan (lihat versi kemudian)                         | Q. Tampilan untuk model dengan remote kontrol*                     |
| B. Tutup filter buang                                      | R. Tampilan untuk model dengan remote kontrol dan fungsi AUTO*     |
| C. Filter buang  | S. Gagang AeroPro Classic*   |
| D. Slot parkir   | T. Gagang AeroPro Ergo*  |
| E. Kabel daya  | U. Gagang Remote Kontrol AeroPro*                                  |
| F. Filter motor  | V. Nozel AeroPro FlowMotion*                                       |
| G. Penahan filter motor                                    | W. Nozel AeroPro FlowMotion LED (high) nozel (dengan lampu depan)* |
| H. S-bag®  | X. Nozel AeroPro Turbo*  |
| I. Penahan S-bag®  | Y. Nozel AeroPro Mini Turbo*                                       |
| J. Penutup ruang debu                                      | Z. Nozel ParkettoPro*  |
| K. Alat AeroPro 3in1                                       | AA. Nozel AeroPro FlexProPlus*                                     |
| L. Slang AeroPro   | AB. Nozel Panjang pipih AeroPro*                                   |
| M. Gagang AeroPro (lihat versi kemudian)                   |  |
| N. Tuba teleskopik AeroPro                                 |  |
| O. Klip parkir   |  |
| P. Tampilan untuk model dengan kontrol manual kenop putar* |  |

\*Hanya model tertentu

### CARA MENGGUNAKAN PENGISAP DEBU INI

- 1 Buka penutup ruang debu dengan menarik tombol S-BAG. Pastikan bahwa kantong debu (s-bag) berada di tempatnya.
- 2 Masukkan slang ke dalam pengisap debu (untuk melepaskannya, tekan tombol kunci dan tarik). Masukkan slang ke dalam gagang slang sampai tombol kunci mengeklik (untuk melepaskannya, tekan tombol kunci lalu tarik).
- 3 Pasang tuba teleskopik pada nozel. Pasang tuba teleskopik pada gagang slang (untuk melepaskan, tekan tombol kunci lalu tarik).
- 4 Sesuaikan tuba teleskopik dengan cara memegang kunci dengan satu tangan dan menarik gagang dengan tangan satunya.

### HIDUPKAN/HENTIKAN PENGISAP DEBU DAN SESUAIKAN DAYA ISAPNYA

- 5 Tarik keluar kabel daya dan tancapkan ke stopkontak listrik. Tekan tombol ON/OFF untuk menghidupkan/mematikan pengisap debu. Indikator-indikator menyala, indikator MIN/MAX menyala dari kiri ke kanan dan kembali (model fungsi otomatis).\* Model dengan remote kontrol juga dapat dioperasikan dengan tombol ON/OFF pada gagangnya.\*
- 6 Sesuaikan daya isap (model kontrol manual): Putar kenop putar pada pengisap debu atau gunakan katup udara pada gagang.\*
- 7 Sesuaikan daya isap (model remote kontrol): Tekan tombol +/- pada gagang. MIN/MAX dan indikator simbol pada tampilan akan memperlihatkan tingkat daya.\*
- 8 Sesuaikan daya isap (model remote kontrol dengan AUTO): Pengisap debu menyala dalam mode AUTO (pengaturan daya otomatis). Indikator AUTO menyala pada tampilan dan indikator MIN/MAX berkedip-kedip. Untuk mengatur daya secara manual, tekan tombol +/- pada gagang. Tekan tombol AUTO untuk kembali ke fungsi otomatis.\*
- 9 Setelah membersihkan, tekan tombol REWIND untuk menggulung kabel.

### POSISI PARKIR

- 10 Gunakan posisi parkir pada sisi (A) atau di bawah (C) untuk membawa dan menyimpan pengisap debu. Pada bagian belakang (B) ketika Anda beristirahat (mengistirahatkan punggung Anda).

### MENGGANTI KANTUNG DEBU, S-BAG®

- 11 Ganti s-bag bila
    - **Model P\* dengan kenop putar:** Indikator S-BAG menyala merah
    - **Model Q\* dengan remote kontrol:** Simbol S-BAG menyala merah.
    - **Model R\* dengan remote kontrol dan AUTO:** Indikator S-BAG menyala merah (lampu hijau: kantong OK, lampu kuning: sebentar lagi kantong perlu diganti).

NB: Selalu ganti s-bag bila indikator S-BAG menyala atau memancarkan cahaya merah meskipun s-bag belum penuh (mungkin kantong ini tersumbat) dan setelah menggunakan bubuk pembersih karpet. Untuk mendapatkan kinerja yang terbaik, gunakan kantong Ultra Long Performance yang secara khusus dibuat untuk pengisap debu Anda. S-bag sintetis lain juga dapat digunakan. Jangan gunakan kantong debu kertas! [www.s-bag.com](http://www.s-bag.com)
  - 12 Tarik tombol S-BAG untuk membuka ruang debu. Gagang penahan s-bag akan naik. Tarik gagang untuk melepaskan s-bag dengan penahannya. Jangan menekan tombol pelepas.
  - 13 Pegang s-bag dengan penahan di atas wadah pembuangan debu. Tekan tombol untuk melepaskan s-bag. Masukkan s-bag baru ke penahan dengan memasukkan kardus di bagian belakang penahan.
  - 14 Masukkan s-bag dengan penahan dengan cara mendorongnya lurus ke dalam jalurnya. Pastikan bahwa s-bag tidak macet di bawah penahan. Pasang tutup. Jika s-bag tidak terpasang dengan benar atau tidak ada/tidak terpasang, tutup tidak akan mau menutup.
- NB: Bila Anda menjalankan pengisap debu setelah mengganti s-bag, akan dibutuhkan 10 detik sebelum indikator S-BAG mati (Model P\* dengan kenop putar dan Model Q\* dengan remote kontrol) atau berubah menjadi hijau (Model R\* dengan remote kontrol dan AUTO).

### MENGGANTI FILTER

- 15 Ganti/bersihkan\*\* filter ketika (\*\*khusus filter yang dapat dicuci)
  - **Model P\* dengan kenop putar:** Anda telah mengganti s-bag 5 kali
  - **Model Q\* dengan remote kontrol:** Simbol FILTER menyala merah
  - **Model R\* dengan remote kontrol dan AUTO:** indikator filter menyala merah. Lampu hijau menunjukkan bahwa filter dalam keadaan baik. Lampu ini menyala sesaat ketika Anda menghidupkan pengisap debu.
- 16 Tarik tombol FILTER untuk membuka tutup filter. Gunakan s-filter asli. Lepaskan filter dan periksa referensi pada bingkai untuk menentukan tipenya. Ganti dengan filter baru atau bersihkan\*\*. Bilas bagian dalam (sisi kotor) dalam air keran hangat-hangat kuku. Ketuk-ketuk bingkai filter untuk meniriskan air. Ulangi proses ini empat kali. (\*\*khusus filter yang dapat dicuci)

NB: Jangan gunakan zat pembersih. Hindari menyentuh permukaan filter. Biarkan filter menjadi kering sepenuhnya (min. 24 jam dalam suhu ruangan) sebelum memasangnya! Ganti filter yang dapat dicuci sedikitnya sekali setahun atau ketika filter sudah sangat kotor atau rusak. Jangan melepaskan busa berbentuk L di bawah filter.
- 17 Setelah mengganti filter, tutupkan tutup filter sampai mengeklik kembali di tempatnya. Jika tutup filter terlepas, posisikan engsel-enselnya di bagian bawah dan tekan tutup filter sampai mengeklik kembali di tempatnya.

NB: Bila Anda menjalankan pengisap debu setelah mengganti filter, akan dibutuhkan 10 detik sebelum indikator FILTER berubah menjadi hijau (model dengan remote kontrol dan fungsi AUTO) atau mati (model remote kontrol).\*
- 18 Ganti filter motor bila sudah kotor atau setiap kali setelah 5 kali mengganti s-bag. Tekan penahan filter ke bawah dan tarik keluar. Ganti filter dan pasang tutupnya.

### MENGISAP DEBU DENGAN NOZEL UNIVERSAL (V\*, W\*)

- 19 Ubah pengaturan nozel dengan pedal. Ikon mengilustrasikan jenis lantai yang direkomendasikan.
- 20 Nozel FlowMotion LED (high)\*: Gerakkan nozel ke depan. Lampu depan menyala secara otomatis setelah beberapa detik. Ketika nozel tidak digunakan, lampu akan mati secara otomatis setelah beberapa detik.

### MEMBERSIHKAN NOZEL UNIVERSAL (V\*, W\*\*)

- 21 Lepaskan nozel dari tuba. Bersihkan dengan gagang nozel.

### MEMBERSIHKAN NOZEL TURBO (X\*)

- 22 Lepaskan nozel dari tuba dan lepaskan benang dan segala benda yang tersangkut dengan gunting. Gunakan gagang slang untuk

membersihkan nozel. \*

**ALAT AKSESORI 3IN1**

- 23 Tarik tab tekstil untuk mengeluarkan alat 3in1. Alat ini memiliki 3 fungsi; lihat gambar pada halaman berikutnya.
- 24 Setelah digunakan, letakkan kembali di tempatnya.

**MENGGANTI BATERAI\***

- 25 Nozel dengan lampu depan\*: Ganti baterai bila lampu depan mulai berkedip cepat. Gunakan 2 baterai AA.





- 26 Gagang dengan remote kontrol\*: Ganti baterai bila indikator lampu berubah merah atau tidak merespons ketika tombol mana pun ditekan. Gunakan hanya baterai tipe LITHIUM CR1632.

NB: Lepaskan baterai dari produk sebelum membuang produk yang sudah tidak digunakan. Ikuti peraturan negara Anda untuk pengumpulan baterai dan produk-produk listrik.

**Nikmati pengalaman membersihkan yang luar biasa dengan PURED9!**

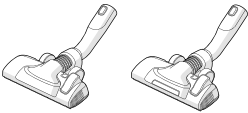
Electrolux berhak untuk mengubah produk, informasi, dan spesifikasinya tanpa pemberitahuan.

**KIAT-KIAT CARA MENDAPATKAN HASIL YANG TERBAIK**

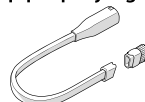
NOZEL/AKSESORI	DIGUNAKAN UNTUK:	NOZEL/AKSESORI	DIGUNAKAN UNTUK:
<p><b>K. Alat aksesoris 3in1*</b></p> 	<p><b>3 alat dalam 1:</b></p> <ol style="list-style-type: none"> <li>1. Alat pembersih debu untuk permukaan keras (rak buku, papan dasar dinding, dll).</li> <li>2. Alat pembungkus sofa untuk tekstil (tirai, pembungkus sofa dll).</li> <li>3. Alat pipih untuk ruang sempit (di belakang radiator dll).</li> </ol>	<p><b>V. Nozel FlowMotion*</b> <b>W. Nozel FlowMotion LED (high) (dengan lampu depan)*</b></p> 	<p><b>Nozel Universal:</b></p> <ul style="list-style-type: none"> <li>- Untuk semua jenis lantai, memastikan pembersihan debu yang terbaik pada lantai karpet dan lantai keras.</li> <li>- Ubah pengaturan nozel dengan pedal. Ikon akan memperlihatkan jenis lantai yang direkomendasikan.</li> <li>- Lampu depan membantu mendeteksi debu dan kotoran di tempat gelap (di bawah perabotan dll). <i>Khusus FlowMotion LED (high) nozel</i></li> </ul>
<p><b>X. Nozel Turbo*</b></p> 	<p><b>Nozel karpet:</b></p> <ul style="list-style-type: none"> <li>- Menyikat dan mengisap secara bersamaan (sangat baik untuk membersihkan rambut, serat, dll).</li> <li>- Roler sikat digerakkan oleh aliran udara dari pengisap debu.</li> <li>- Tidak sesuai untuk karpet dengan bulu sangat dalam dan jumbai panjang, karpet anti-selip seperti keset pintu, atau karpet tahan air. Untuk penggunaan demikian, gunakan nozel universal.</li> </ul>	<p><b>Y. Nozel Mini Turbo*</b></p> 	<p><b>Nozel kain pembungkus sofa:</b></p> <ul style="list-style-type: none"> <li>- Menyikat dan mengisap secara bersamaan (sangat baik untuk membersihkan rambut, serat, dll).</li> <li>- Untuk furnitur tekstil, kursi mobil, kasur, dll.</li> <li>- Roler sikat digerakkan oleh aliran udara dari pengisap debu.</li> <li>- Tidak sesuai untuk karpet dengan bulu sangat dalam dan jumbai panjang karena dapat tersangkut pada rol sikat yang berputar.</li> </ul>
<p><b>Z. Nozel ParkettoPro*</b></p> 	<p><b>Nozel lantai keras:</b></p> <ul style="list-style-type: none"> <li>- Untuk pembersihan lembut lantai keras (parket, lantai kayu, keramik, dll).</li> <li>- Membersihkan debu pada lantai keras paling baik dengan alat pipih.</li> </ul>	<p><b>AA. Nozel FlexProPlus*</b></p> 	<p><b>Nozel lantai keras:</b></p> <ul style="list-style-type: none"> <li>- Untuk menjangkau di bawah/di antara furnitur, sudut, dan halangan lain.</li> <li>- Dapat dengan mudah diputar 180 derajat untuk akses langsung ke ruang sempit.</li> </ul>
<p><b>AB. Nozel pipih panjang*</b></p> 	<p><b>Alat ekstra panjang:</b></p> <ul style="list-style-type: none"> <li>- Untuk area yang sulit dijangkau (bagian atas rak dll).</li> <li>- Untuk ruang sempit (di belakang radiator, di bawah kursi mobil dll).</li> </ul>		

**Model dengan pengaturan daya manual**  
– ikuti gambar pada mesin pengisap untuk kinerja optimal.

**Model dengan fungsi-AUTO secara otomatis menyesuaikan daya isap** untuk memberikan kinerja pembersihan yang optimal dan kenyamanan di setiap permukaan. Untuk pengaturan manual, ikuti gambar untuk kinerja optimal.

**PEMECAHAN MASALAH**

MASALAH	SOLUSI
Pengisap debu tidak mau hidup	<ul style="list-style-type: none"> <li>• Pastikan bahwa kabel terhubung ke jala-jala listrik.</li> <li>• Pastikan bahwa steker dan kabel tidak rusak.</li> <li>• Periksa apakah sekering putus.</li> <li>• Periksa apakah lampu indikator baterai pada gagang remote kontrol merespons (hanya model tertentu).</li> </ul>
Lampu indikator s-bag® menyala	<ul style="list-style-type: none"> <li>• Periksa apakah s-bag® penuh atau tersumbat.</li> <li>• Jika Anda sudah mengganti s-bag®, ganti filter motor.</li> </ul>
Lampu indikator filter menyala (hanya pada model tertentu)	Ganti, atau cuci (jika dapat dicuci), filter buang.
Pengisap debu berhenti	Pengisap debu mungkin terlalu panas: cabut stekernya dari stopkontak; periksa apakah nozel, tuba, slang, atau filternya tersumbat. Biarkan pengisap debu mendingin selama 30 menit sebelum menancapkannya lagi. Jika pengisap debu masih belum mau hidup, hubungi pusat servis resmi Electrolux.
Kapasitas pengisapan berkurang dibandingkan normal	<ul style="list-style-type: none"> <li>• Periksa apakah s-bag penuh atau tersumbat.</li> <li>• Periksa apakah filter motor tersumbat dan perlu diganti.</li> <li>• Periksa apakah nozel tersumbat dan perlu dibersihkan.</li> <li>• Periksa apakah slang tersumbat dengan meremasnya perlahan. Namun, berhati-hatilah, siapa tahu sumbatan disebabkan oleh pecahan kaca atau jarum yang tersangkut di dalam slang.</li> </ul> <p>Catatan: Garansi tidak mencakup kerusakan pada slang yang terjadi ketika membersihkannya.</p>
Air telah tersedot masuk ke dalam pengisap debu.	Anda perlu mengganti motor ke pusat servis resmi Electrolux. Kerusakan motor yang disebabkan karena masuknya air tidak dilindungi oleh garansi.

**Untuk masalah yang lebih jauh, hubungi pusat servis resmi Electrolux.**

## LANGKAH PENCEGAHAN UNTUK KESELAMATAN

Alat ini dapat digunakan oleh anak-anak berusia setidaknya 8 tahun atau lebih serta orang dengan kemampuan mental, indra, dan fisik yang kurang atau memiliki hanya sedikit pengalaman dan pengetahuan jika mereka diberi pengawasan dan pengarahan tentang cara menggunakan alat ini secara aman dan mengetahui bahaya-bahaya yang ada.

Anak-anak hendaknya tidak bermain dengan perangkat ini.

Pembersihan dan perawatan tidak boleh dilakukan oleh anak-anak tanpa pengawasan.

**PERINGATAN:** Nozel Turbo\* dilengkapi sikat berputar yang dapat memerangkap benda apa saja. Gunakan dengan hati-hati dan hanya pada permukaan yang dimaksudkan. Matikan pengisap debu sebelum melepaskan benda yang terperangkap atau membersihkan sikat.

Baterai harus dilepas dari remote kontrol pada gagang\* / nozel berlampu LED\* sebelum membuang produk yang sudah tidak digunakan\*\*.

\*Hanya model tertentu.

\*\*Informasi mengenai cara melepas baterai di bagian lipatan bagian 25 dan 26.

Selalu cabut steker dari stopkontak listrik sebelum membersihkan atau merawat perangkat atau ketika melepaskan baterai. Baterai harus dibuang dengan aman.

Jika rusak, kabel listrik perangkat ini harus diganti hanya oleh pusat servis resmi Electrolux untuk menghindari bahaya.

PURED9 harus digunakan hanya untuk pengisapan debu di dalam ruangan secara normal dan di lingkungan rumah tangga. Pastikan bahwa pengisap debu disimpan di tempat yang kering.

Semua servis atau perbaikan harus dilakukan oleh pusat servis resmi Electrolux.

Bahan kemasan, misalnya kantung plastik harus dijauhkan dari jangkauan anak-anak agar tidak tertelan.

### Jangan pernah menggunakan pengisap debu:

Di tempat basah.

Di dekat gas yang mudah terbakar, dll.

Saat produk menunjukkan tanda-tanda kerusakan yang jelas.

Di atas permukaan benda cair atau tajam.

Bila nozel lantai menunjukkan tanda-tanda kerusakan yang jelas.

Pada abu yang panas atau dingin, puntung rokok yang menyala, dll.

Pada debu halus, misalnya dari plester, beton, tepung, serta abu panas atau dingin.

Jangan letakkan pengisap debu di bawah sinar matahari langsung.

Hindari mendekatkan pengisap debu ke panas yang tinggi atau suhu dingin.

Jangan sekali-kali menggunakan pengisap debu tanpa filternya.

Jangan coba untuk menyentuh rol sikat saat pembersih menyala dan rol sikat sedang berputar.

Saat roda-rodanya terblokir.

### Langkah pencegahan kabel daya

Periksa steker dan kabel secara teratur. Jangan sekali-kali menggunakan pengisap debu jika steker atau kabelnya rusak.

Kerusakan pada kabel pengisap debu tidak dilindungi oleh garansi.

Jangan sekali-kali menarik atau mengangkat pengisap debu dari kabelnya.

Menggunakan pengisap debu di lingkungan di atas dapat menyebabkan cedera serius atau kerusakan pada produk. Cedera atau kerusakan tersebut tidak dilindungi oleh garansi atau oleh Electrolux.

### SERVIS DAN GARANSI

Semua servis atau perbaikan harus dilakukan oleh pusat servis resmi Electrolux.

Kerusakan pada kabel pengisap debu tidak dilindungi oleh garansi.

Kerusakan pada motor yang disebabkan oleh; terisapnya cairan, terendamnya perangkat dalam cairan, atau digunakannya perangkat dengan slang dan nozel rusak tidak dilindungi oleh garansi.

Selalu gunakan kantung debu s-bag asli yang sesuai untuk pengisap debu ini, lihat bagian 11. Kerusakan yang disebabkan oleh penggunaan kantung debu non-asli secara tidak benar tidak dilindungi oleh garansi.

### PEMBUANGAN

Simbol ini pada produk menunjukkan bahwa pada produk ini terpasang baterai yang tidak boleh dibuang sembarangan dengan limbah rumah tangga biasa.

Simbol ini pada produk atau kemasannya menunjukkan bahwa produk tersebut tidak boleh diperlakukan seperti limbah rumah tangga.

Untuk mendaur ulang produk Anda, bawa produk ke tempat pengumpulan resmi atau ke pusat servis Electrolux yang dapat melepas dan mendaur ulang baterai serta aneka komponen listrik dengan cara yang aman dan profesional. Patuhi peraturan negara Anda untuk pengumpulan aneka produk listrik yang terpisah serta baterai yang dapat diisi ulang.

Dengan ini, Electrolux Home Care and SDA, menyatakan bahwa Pengisap Debu (Vacuum Cleaner) dengan peralatan radio tipe HER2 dan HER3 adalah sesuai dengan Directive 2014/53/EU.

### CATATAN MENGENAI PERATURAN LABEL ENERGI

Pengisap debu ini merupakan pengisap debu untuk tujuan umum. Untuk mencapai efisiensi energi dan kinerja pembersihan yang dinyatakan untuk karpet, gunakan nozel universal yang dapat dipertukarkan

“FlowMotion / FlowMotion LED (high)”.

Untuk mencapai kinerja pembersihan yang dinyatakan untuk lantai keras dengan alat pipih, gunakan nozel lantai keras spesifik “Parketto Pro” bila ditentukan dan disertakan dalam kemasan, atau gunakan nozel universal yang bisa dipertukarkan “FlowMotion / FlowMotion LED (high)”.

Buku petunjuk ini, fiche dan label energi untuk pengisap debu spesifik ini dapat diunduh dari situs web kami, [www.electrolux.com](http://www.electrolux.com).

Perhitungannya didasarkan pada Commission Delegated Regulation (EU) No 665/2013 tanggal 3 Mei 2013 yang melengkapi Directive 2010/30/EU. Semua prosedur dalam petunjuk ini yang tidak diuraikan dalam detail yang lebih presisi didasarkan pada EN 60312-1:2013.

한국어

Electrolux PURED9 진공 청소기를 선택해 주셔서 감사합니다. 최상의 결과를 얻기 위해 항상 순정 액세서리 및 예비 부품을 사용하십시오. 이 제품은 환경을 감안해 설계되었습니다. 모든 플라스틱 부품에는 재활용을 위한 표시가 되어 있습니다.

시작하기 전에

- 이 설명서를 주의깊게 정독하십시오.
- 설명되어 있는 모든 부품들이 포함되어 있는지 확인하십시오.
- 안전 주의 사항 내용에 특별히 주의를 기울여 주십시오.

PURED9 진공 청소기 설명

- |                                    |   |
|------------------------------------|---|
| A. 디스플레이 (모델별 상이함)                 | Q. 리모콘 지원 모델용 디스플레이*                          |
| B. 배기 필터 덮개                        | R. 리모콘 및 AUTO 기능 지원 모델용 디스플레이*                |
| C. 배기 필터                           | S. AeroPro Classic 손잡이*                       |
| D. 고정 슬롯                           | T. AeroPro Ergo 손잡이*                          |
| E. 전원코드                            | U. AeroPro 리모콘 손잡이*                           |
| F. 모터 필터                           | V. AeroPro FlowMotion 노즐*                     |
| G. 모터 필터 홀더                        | W. AeroPro FlowMotion LED (high) 노즐 (전면등 포함)* |
| H. S-bag®                          | X. AeroPro 터보 노즐*                             |
| I. S-bag® 홀더                       | Y. AeroPro 미니 터보 노즐*                          |
| J. 먼지통 덮개                          | Z. ParkettoPro 노즐*                            |
| K. AeroPro 3in1 툴                  | AA. AeroPro FlexProPlus 노즐*                   |
| L. AeroPro 호스                      | AB. AeroPro 긴 틸트 노즐*                          |
| M. AeroPro 손잡이 (다음 버전 참조)          |   |
| N. AeroPro 텔레스코픽 튜브                |   |
| O. 고정용 클립                          |   |
| P. 회전식 노브를 이용한 수동 제어 지원 모델용 디스플레이* | * 특정 모델에만 적용                                  |

진공 청소기 사용 방법

- 1 S-BAG 버튼을 당겨 먼지통 덮개를 엽니다. 먼지 봉투(s-bag)가 제 위치에 있는지 확인합니다.
- 2 호스를 청소기에 끼웁니다(분리하려면 잠금 버튼을 누른 뒤 당김). 잠금 버튼이 찰카하고 잠길 때까지 호스를 호스 손잡이에 끼웁니다(분리하려면 잠금 버튼을 누른 채 당김)
- 3 노즐에 텔레스코픽 튜브를 부착합니다. 호스 손잡이에 텔레스코픽 튜브를 부착합니다(분리하려면 잠금 버튼을 누른 뒤 당김).
- 4 한 손으로 잠금 버튼을 누르고 다른 손으로 손잡이를 당겨 텔레스코픽 튜브를 조절합니다.

진공 청소기를 가동시킨 뒤 흡입력을 조정합니다.

- 5 전원코드를 당겨 콘센트에 꽂습니다. 청소기를 켜거나 끄려면 ON/OFF 버튼을 누릅니다. 표시등이 켜지고 왼쪽에서 오른쪽으로, 그리고 다시 반대 방향으로 MIN/MAX 표시등이 움직입니다(자동 기능 모델).\* 리모콘 지원 모델도 손잡이의 ON/OFF 버튼으로 작동시킬 수 있습니다.\*
- 6 흡입력 조절(수동 제어 모델): 청소기의 회전식 노브를 돌리거나 에어 밸브를 이용합니다.\*
- 7 흡입력 조절(리모콘 지원 모델): 손잡이의 +/- 버튼을 누릅니다. 디스플레이의 MIN/MAX 및 기호 표시등이 흡입력 단계를 보여 줍니다.\*
- 8 흡입력 조절(AUTO 기능 및 리모콘 지원 모델): 청소기가 AUTO 모드로 시작됩니다(자동 출력 조절). 디스플레이에 AUTO 표시등이 켜지고 MIN/MAX 표시등이 깜박입니다. 흡입력을 수동 조절하려면 손잡이의 +/- 버튼을 누르십시오. 자동 기능으로 돌아가려면 AUTO 버튼을 누릅니다.\*
- 9 청소 후 전원코드를 감으려면 REWIND 버튼을 누릅니다.

노즐 고정용 홈

- 10 청소기를 옮기거나 보관할 때는 측면 (A) 또는 바닥 (C)의 노즐 고정용 홈을 이용하고 잠깐 쉴 때는 뒷면 (B)에 고정하십시오.

먼지 봉투(S-BAG®) 교체

- 11 다음과 같은 경우 s-bag을 교체하십시오.  
- P\* 회전식 노브가 장착된 P\* 모델: 적색 S-BAG 표시등이 켜짐

- 리모콘 지원 Q\* 모델: 적색 S-BAG 기호 표시등이 켜짐.
- 리모콘 및 AUTO 기능 지원 R\* 모델: 적색 S-BAG 표시등 켜짐(녹색 등: 봉투 상태 좋음, 노란 등: 봉투 교체 시기 임박).

NB: s-bag이 가득 차지 않았더라도 S-BAG 표시등이 켜지거나 적색등이 켜졌거나 카펫 청소용 세제를 사용한 후에는 항상 봉투를 교체하십시오

(봉투가 막혀 있을 수 있음). 최고의 성능을 유지하려면 사용하는 청소기에 맞게 특별히 개발된 울트라 롱 퍼포먼스 백을 사용하십시오. 다른 합성 s-bag도 사용할 수 있습니다. 종이 재질의 먼지 봉투는 사용하지 마십시오! www.s-bag.com

- 12 S-BAG 버튼을 당겨 먼지통을 엽니다. s-bag 홀더 손잡이가 위로 올라옵니다. 손잡이를 당겨 홀더와 함께 s-bag을 분리합니다. 분리 버튼을 누르지 마십시오.
- 13 홀더에 삽입된 상태의 s-bag을 쓰레기통으로 옮깁니다. 버튼을 눌러 s-bag을 분리합니다. 홀더 뒤쪽에 보드지/플라스틱을 끼워 홀더에 새 s-bag을 삽입합니다.
- 14 홀더에 끼운 s-bag을 아래로 눌러 제 위치에 끼웁니다. s-bag이 홀더 아래 놓리지 않도록 하십시오. 뚜껑을 닫으십시오. s-bag 위치가 올바르게 앉거나 빠뜨렸을 경우 뚜껑이 닫히지 않습니다.  
NB: s-bag 교체 후 청소기를 가동하면 S-BAG 표시등이 꺼지거나(회전식 노브 장착 P\* 모델과 리모콘 지원 Q\* 모델) 녹색으로 바뀔 때까지(리모콘 및 AUTO 기능 지원 R\* 모델) 10초가 소요됩니다.

필터 교체

- 15 다음과 같은 경우 필터를 교체/세척하십시오\*\*(세척 가능 필터에 한함)  
-회전식 노브 장착 P\* 모델: s-bag 5회 교체 시마다  
-리모콘 지원 Q\* 모델: FILTER 기호가 적색으로 표시됨  
-리모콘 및 AUTO기능 지원 R\* 모델: 적색 필터 표시등 켜짐. 녹색 표시등은 필터 상태가 정상임을 나타냅니다. 진공 청소기 가동을 시작할 때 잠깐 켜집니다.
- 16 FILTER 버튼을 당겨 필터 덮개를 엽니다. 정품 s-필터를 사용하십시오. 필터를 분리한 뒤 프레임의 참조 번호를 통해 필터 종류를 확인합니다. 새 필터로 교체하거나 청소합니다\*\*. 미지근한 수돗물로 안쪽(더러운 쪽)을 행굽니다. 필터 프레임에 두드러 물을 떨어내십시오. 행굽 과정을 네 번 반복합니다. (\*\*세척 가능 필터에 한함)  
NB: 세제는 사용하지 마십시오. 필터 표면에 손을 대는 일은 피하십시오. 필터를 다시 장착하기 전에 완전히 말리십시오(실내 온도에서 최소 24시간)! 세척 가능 필터는 최소 일년에 한 번 또는 더럽거나 손상되었을 때 교체하십시오. 필터 아래에 있는 L자형 폼은 제거하지 마십시오.
- 17 필터를 교체한 뒤 필터 덮개를 딸깍 소리가 날 때까지 눌러 닫아두십시오. 필터 덮개가 분리된 경우에는 힌지가 아래를 향하도록 한 뒤 딸깍 소리가 날 때까지 필터 덮개를 눌러 원위치시키십시오.  
NB: 필터 교체 후 청소기를 가동하면 녹색 FILTER 표시등이 켜지거나(리모콘 및 AUTO 기능 지원 모델) 꺼질 때까지(리모콘 지원 모델) 10초가 소요됩니다.\*
- 18 모터 필터는 더러워지거나 s-bag을 5회 교체한 경우 교체합니다. 필터 홀더를 아래쪽으로 누른 뒤 당겨 빼냅니다. 필터를 교체한 뒤 덮개를 닫습니다.

일반 노즐을 사용한 진공 청소(V\*, W\*)

- 19 페달을 이용해 노즐 설정을 변경합니다. 적합한 바닥 유형을 나타내는 아이콘이 표시됩니다.
- 20 FlowMotion LED (high) 노즐\*: 노즐을 앞으로 밀니다. 몇 초 뒤 전면등이 자동으로 켜집니다. 노즐을 사용하지 않으면 몇 초 뒤 조명이 자동으로 꺼집니다.

일반 노즐 청소(V\*, W\*)

- 21 튜브에서 노즐을 분리합니다. 호스 손잡이로 청소합니다.

터보 노즐 청소(X\*)

- 22 튜브에서 노즐을 분리한 뒤 실이 얽혀 있으면 가위로 잘라 제거하십시오. 호스 손잡이를 이용해 노즐을 청소합니다. \*

3IN1 액세서리 툴

- 23 천 소재 끈을 당겨 3in1 툴을 꺼냅니다. 툴은 3가지 기능을 갖고 있습니다. 다음 페이지를 참조하십시오.
- 24 사용 후에는 원래 위치에 넣으십시오.

배터리 교체\*





- 25 전면등 내장 노즐\*: 전면등이 빠르게 깜박이기 시작하면 건전지를 교체하십시오. AA 건전지 2개를 사용합니다.
- 26 리모콘 내장 손잡이\*: 적색 표시등이 켜지거나 버튼을 눌러도 아무런 응답이 없으면 건전지를 교체하십시오. CR1632 리튬 건지 유형만 사용하십시오.

NB: 폐기하기 전에 제품에서 건전지를 제거하십시오. 건전지 및 전기 제품 수거에 대한 거주 국가 규정을 따르십시오.

PURED9과 함께 멋진 청소 경험을 누리세요!

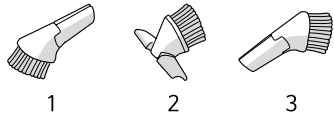
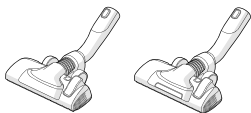
Electrolux는 통보 없이 제품, 정보 및 사양을 변경할 권한이 있습니다.

최상의 결과를 얻기 위한 팁

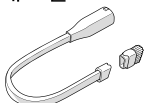
노즐/액세서리	용도:	노즐/액세서리	용도:
<b>K. 3in1 액세서리 툴*</b> 	3개의 툴을 1개로 결합: 1. 단단한 면(예: 책장, 가구 위)의 먼지 제거용 툴. 2. 섬유 소재 실내장식용(예: 커튼, 실내 장식). 3. 좁은 공간(예: 라디에이터 뒤쪽)을 위한 틈새용 툴.	<b>V. FlowMotion 노즐* W. FlowMotion LED (high) 노즐 (전면등 포함)*</b> 	<b>일반 노즐:</b> - 모든 바닥 유형용, 카펫 및 단단한 바닥의 먼지 제거에 최적입니다. - 페달을 이용해 노즐 설정을 변경합니다. 적합한 바닥 유형을 나타내는 아이콘이 표시됩니다. - 전면등이 있어 어두운 곳(예: 가구 아래)에서의 먼지 및 오물 감지에 도움이 됩니다. FlowMotion LED (high) 노즐 전용
<b>X. 터보 노즐*</b> 	<b>카펫 노즐:</b> - 빗질 및 진공 청소를 동시에 수행합니다(머리카락, 섬유 등의 청소에 최적). - 브러쉬 롤러는 진공 청소기의 공기 흐름에 의해 구동됩니다. - 아주 두껍고 털이 긴 카펫, 도어 매트와 같은 미끄럼 방지 카펫이나 방수 카펫에는 부적합합니다. 일반 노즐을 대신 사용하십시오.	<b>Y. 미니 터보 노즐*</b> 	<b>실내 장식용 노즐:</b> - 빗질 및 진공 청소를 동시에 수행합니다(머리카락, 섬유 등의 청소에 최적). - 섬유 소재 가구, 카시트, 매트리스 등. - 브러쉬 롤러는 진공 청소기의 공기 흐름에 의해 구동됩니다. - 회전 브러쉬 롤이 걸릴 수 있어 아주 두껍고 털이 긴 카펫에는 부적합합니다.
<b>Z. ParkettoPro 노즐*</b> 	<b>단단한 바닥용 노즐:</b> - 단단한 바닥의 가벼운 청소용(조각 세공 나무 소재 또는 목재 마루, 타일 등). - 틈새가 있는 단단한 바닥의 먼지 제거에 최적.	<b>AA. FlexProPlus 노즐*</b> 	<b>단단한 바닥용 노즐:</b> - 가구, 코너 및 기타 장애물 아래나 그 사이를 청소합니다. - 손쉽게 180도 돌려 좁은 공간에 바로 접근할 수 있습니다.
<b>AB. 긴 틈새 노즐*</b> 	<b>아주 긴 툴:</b> - 접근이 힘든 곳(예: 선반 위)의 청소용. - 좁은 공간(예: 라디에이터 뒤쪽)을 위한 툴.		

<b>흡입력 수동 조절 모델</b> - 최적의 성능을 위한 청소기 안내도를 참조하십시오.	<b>AUTO 기능 지원 모델들은 흡입력을 자동으로 조절합니다.</b> 이로 인해 최적의 청소 성능을 제공하고 어떤 곳이든 편안하게 청소할 수 있습니다. 수동 조절의 경우 최적 성능을 위한 안내도를 참조하십시오.
--	---

문제해결

문제	해결책
진공 청소기가 시작되지 않습니다.	<ul style="list-style-type: none"> <li>전원코드가 콘센트에 꽂혀 있는지 확인하십시오.</li> <li>플러그와 전원코드가 훼손되지 않았는지 점검하십시오.</li> <li>퓨즈가 끊어졌는지 확인하십시오.</li> <li>리모콘 손잡이의 건전지 표시등에 반응이 있는지 확인하십시오(일부 모델에 한함).</li> </ul>
s-bag® 표시등이 켜집니다.	<ul style="list-style-type: none"> <li>s-bag®이 가득 찼거나 막혔는지 확인하십시오.</li> <li>s-bag®을 이미 교체했다면 모터 필터를 교체하십시오.</li> </ul>
필터 표시등이 켜집니다(특정 모델에 한함).	배기 필터를 교체하거나 세척 가능하면 세척하십시오.
청소기가 멈춤	청소기가 과열되었을 수 있습니다: 콘센트에서 분리한 뒤 노즐, 튜브, 호스 또는 필터가 막혔는지 확인하십시오. 30분 간 청소를 식힌 뒤 전원을 다시 연결하십시오. 그래도 청소기가 작동하지 않으면 Electrolux 공인 서비스 센터에 문의하십시오.
정상 출력 대비 갑작스러운 흡입 능력 감소	<ul style="list-style-type: none"> <li>s-bag®이 가득 찼거나 막혔는지 확인하십시오.</li> <li>모터 필터가 막혀 교체해야 하는지 확인하십시오.</li> <li>노즐이 막혀 청소해야 하는지 확인하십시오.</li> <li>호스를 가볍게 눌러 막히지 않았는지 확인하십시오. 하지만 호스 안의 유리나 바늘이 막 원인일 경우 주의하십시오.</li> </ul> 참고: 청소로 인해 발생한 호스 손상은 보증 서비스를 받을 수 없습니다.
진공 청소기에 물이 들어갔습니다.	모터 교체는 공인 Electrolux 서비스 센터에서 수행해야 합니다. 물이 스며들어 발생한 모터 손상은 보증 서비스를 받을 수 없습니다.
그 밖에 추가 문제가 있을 경우 공인 Electrolux 서비스 센터에 연락하십시오.	

안전 주의 사항

8세 이상 어린이 및 신체, 감각 또는 지적 능력이 낮거나 경험과 지식이 부족한 사람의 경우 안전한 제품 사용과 관련된 지시 또는 감독을 받고 제품 사용과 관련된 위험을 이해하는 경우 이 제품을 사용할 수 있습니다.

어린이가 제품을 갖고 놀지 못하게 해야 합니다.

감독 없이 어린이가 청소 및 정비를 수행해서는 안 됩니다.

**경고:** 터보 노즐\*에는 부품들이 걸릴 수 있는 회전 브러시가 있습니다. 적합한 면에서만 주의하여 사용하십시오. 걸린 부품을 분리하거나 브러시를 청소하기 전에 진공 청소기를 먼저 끄십시오.

제품을 폐기하기 전에 먼저 손잡이 리모콘\*/LED 조명 노즐에서 건전지를 분리해야 합니다\*\*.

**\*특정 모델에만 적용**

**\*\*건전지 제거 방법에 대한 정보는 부품 설명도 섹션 25 및 26 참조.**

진공 청소기를 청소하거나 유지보수하거나 건전지를 제거하려면 항상 먼저 콘센트에서 플러그를 뽑으십시오. 배터리는 안전하게 폐기해야 합니다.

전원코드가 손상된 경우 위험 방지를 위해 공인 Electrolux 서비스 센터를 통해서만 교체해야

합니다.

PURED9는 실내 및 가정에서의 일반 진공 청소용으로만 사용해야 합니다. 진공 청소기는 반드시 건조한 장소에 보관하십시오. 모든 정비나 수리는 공인 Electrolux 서비스 센터에서 수행해야 합니다. 질식을 방지하기 위해 아이들이 비닐 백과 같은 포장재에 접근하지 못하도록 하십시오.

- 다음과 같은 경우에는 절대 진공 청소기를 사용하지 마십시오.
- 공간이 습한 경우.
- 가연성 가스 가까이 있는 경우
- 제품이 손상된 징후가 보이는 경우.
- 날카로운 물체 또는 액체가 있는 경우.
- 바닥용 노즐에 손상된 징후가 보이는 경우.
- 뜨겁거나 식은 재, 불씨가 있는 담배 공초 등이 있는 경우.
- 석고, 콘크리트 먼지, 밀가루, 뜨겁거나 식은 재와 같은 먼지가 있는 경우.
- 직사광선에 진공 청소기를 방치하지 마십시오.
- 강한 열기나 영하의 온도에 진공 청소기를 노출시키지 마십시오.
- 필터를 제거한 채로는 절대 진공 청소기를 사용하지 마십시오.
- 청소기가 켜져 있고 브러쉬 롤이 회전하는 중에 브러쉬 롤에 손을 대지 마십시오.
- 휠이 움직이지 않는 경우

전원코드 주의 사항

플러그와 전원코드를 정기적으로 점검하십시오. 전원코드가 훼손된 경우 절대 진공 청소기를 사용하지 마십시오. 진공 청소기 전원코드 손상은 보증 대상이 아닙니다. 절대 전원코드로 진공 청소기를 당기거나 들어올리지 마십시오. 위의 환경에서 진공 청소기를 사용할 경우 심각한 부상을 입거나 제품 손상을 가져올 수 있습니다. 이러한 부상 또는 손상에 대해서는 Electrolux의 보증 서비스를 받을 수 없습니다.

정비 및 보증

모든 정비나 수리는 공인 Electrolux 서비스 센터에서 수행해야 합니다. 진공 청소기 전원코드 손상은 보증 대상이 아닙니다. 물을 빨아들이거나 청소기를 액체에 담그거나 호스 및 노즐이 손상된 청소기를 사용해 발생한 모터 손상은 보증 서비스를 받을 수 없습니다. 항상 이 진공 청소기에 적합한 정품 s-bag 먼지 봉투를 사용하십시오. 섹션 11을 참조하십시오. 정품이 아닌 먼지 봉투를 잘못 사용해 발생한 청소기 손상에 대해서는 보증이 적용되지 않습니다.

폐기

이 기호는 이 제품에 일반 가정용 폐기물로 버릴 수 없는 건전지가 들어 있음을 나타냅니다.

제품 또는 포장에 이 기호가 있으면 이 제품을 가정용 폐기물로 처리할 수 없다는 표시입니다.

제품을 재활용하려면 안전하고 전문적인 방식으로 배터리 및 부품을 분리할 수 있는 공식 수거 장소 또는 Electrolux 서비스 센터에 가져가십시오. 전기 제품 및 충전지 분리 수거를 위한 거주 국가의 규정에 따르십시오.

이 문서에 의해 Electrolux Home Care 및 SDA는 무선 기기 유형 HER2 및 HER3가 내장된 진공 청소기가 유럽 무선장비지침(Directive 2014/53/EU)을 준수함을 선언합니다.

에너지 라벨 규정 참고 사항

이 진공 청소기는 일반용 진공 청소기입니다. 카펫 청소에 대해 표시된 에너지 효율과 청소 성능을 달성하기 위해서는 교체형 일반 노즐 "FlowMotion / FlowMotion LED (high)"을 사용하십시오. 틈새가 있는 단단한 바닥 청소에 대해 표시된 청소 성능을 달성하기 위해서는 지정되어 있고 패키지에 포함되어 있을 경우에는 전용 단단한 바닥용 노즐인 "Parketto Pro"를 사용하고, 그렇지 않을 경우에는 교체형 일반 노즐인 "FlowMotion / FlowMotion LED (high)"을 사용하십시오. 이 설명서, 청소기별 피시 및 에너지 라벨은 당사 홈페이지인 [www.electrolux.com](http://www.electrolux.com)에서 다운로드할 수 있습니다. 계산값은 Directive 2010/30/EU를 보완하는 2013년 5월 3일 발효된 Commission Delegated Regulation (EU) No 665/2013을 기준으로 합니다. 보다 자세한 기술되지 않은 이 설명서의 모든 절차는 EN 60312-1:2013을 바탕으로 하였습니다.

**ภาษาไทย**

ขอคุณที่เลือกใช้เครื่องดูดฝุ่นอิเล็กทรอนิกส์ PURED9 โปรดใช้อุปกรณ์เสริมและอะไหล่ต่างๆ ที่เป็นของแท้เพื่อให้ได้ผลลัพธ์การทำงานที่ดีที่สุด ผลิตภัณฑ์นี้ออกแบบมาโดยตระหนักถึงความสำคัญของสิ่งแวดล้อม ชิ้นส่วนพลาสติกทั้งหมดจะมีสัญลักษณ์เพื่อการรีไซเคิล

**ก่อนเริ่มใช้งาน**

- โปรดอ่านคู่มือนี้อย่างละเอียด
- ตรวจสอบว่าทุกชิ้นส่วนที่อธิบายไว้มีให้มาครบ
- ใส่ใจต่อข้อควรระวังเพื่อความปลอดภัยเป็นพิเศษ!

**คำอธิบายของเครื่องดูดฝุ่นรุ่น PURED9**

- |   |  |
|---|--|
| A. แผงแสดง (ดูรุ่นในภายหลัง)                            | Q. แผงแป้นของตัวเครื่องพร้อมรีโมทควบคุม*                             |
| B. ฝาครอบตัวกรองฝุ่น                                    | R. แผงแป้นของตัวเครื่องพร้อมรีโมทควบคุมและฟังก์ชันการทำงานอัตโนมัติ* |
| C. ตัวกรองฝุ่น  | S. มีोजับ AeroPro Classic*   |
| D. ช่องเก็บตัวดำ  | T. มีोजับ AeroPro Ergo*  |
| E. สายไฟ  | U. มีोजับ AeroPro แบบมีรีโมทควบคุม*                                  |
| F. แผ่นกรองเครื่องดูดฝุ่น                               | V. หัวดูด AeroPro FlowMotion*  |
| G. ที่ยึดแผ่นกรองเครื่องดูดฝุ่น                         | W. หัวดูด AeroPro FlowMotion LED (high) (มีไฟด้านหน้า)*              |
| H. ถังเก็บฝุ่น S-bag®                                   | X. หัวดูด AeroPro Turbo*   |
| I. ที่ยึดถังเก็บฝุ่น S-bag®                             | Y. หัวดูด AeroPro Mini Turbo*  |
| J. ฝาปิดส่วนเก็บฝุ่น                                    | Z. หัวดูด Parketto Pro*  |
| K. เครื่องมือ AeroPro 3in1                              | AA. หัวดูด AeroPro FlexProPlus*                                      |
| L. สายยาง AeroPro                                       | AB. หัวดูด AeroPro ปากแคมดำยาว*                                      |
| M. มีोजับ AeroPro (ดูรุ่นในภายหลัง)                     |  |
| N. ท่อดูดฝุ่น AeroPro                                   |  |
| O. ตัวหนีบเก็บดำ  |  |
| P. แผงแป้นของตัวเครื่องพร้อมปุ่มหมุนการควบคุมแบบแมนนวล* |  |

\* ใช้กับเครื่องใช้ไฟฟ้าบางรุ่นเท่านั้น

**วิธีใช้งานเครื่องดูดฝุ่น**

- 1 เปิดฝาปิดส่วนเก็บฝุ่นออกโดยการกดและดึงปุ่ม S-BAG ตรวจสอบว่าถังเก็บฝุ่น (s-bag) เข้าที่เรียบร้อยแล้ว
- 2 ใส่สายยางเข้ากับตัวเครื่อง (หากต้องการถอดออก กดปุ่มล็อกและดึงออก) ต่อสายยางเข้ากับตัวมีोजับสายยางจนกว่าปุ่มล็อกจะเข้าที่ (หากต้องการปลดล็อก กดปุ่มล็อกและดึงออกมา)
- 3 ใส่ท่อดูดฝุ่นเข้ากับหัวดูดพื้น ใส่ท่อดูดฝุ่นเข้ากับมีोजับสายยาง (หากต้องการถอดออก กดปุ่มล็อกและดึงออกมา)
- 4 ปรับท่อดูดฝุ่นโดยการกดปุ่มล็อกค้างไว้และใช้มีोजับหนึ่งปรับตั้งมีोजับ

**เริ่ม/หยุดการทำงานของเครื่องดูดฝุ่นและปรับความแรงการดูดฝุ่น**

- 5 ดึงสายไฟออกมาจากเครื่องและเสียบปลั๊กเข้าไปที่เต้ารับ กดปุ่มเปิด/ปิดเพื่อเปิด/ปิดเครื่องดูดฝุ่น ไฟแสดงการทำงานจะสว่างขึ้น ไฟแสดงระดับการทำงานต่ำ/สูง สว่างขึ้นจากทางซ้ายไปทางขวาและทางด้านหลัง (รุ่นที่มีฟังก์ชันการทำงานอัตโนมัติ)\* รุ่นที่มีรีโมทควบคุมยังสามารถใช้งานปุ่มเปิด/ปิดบนตัวมีोजับได้อีกด้วย\*
- 6 ปรับพลังการดูดฝุ่น (รุ่นที่มีการควบคุมแบบแมนนวล): หมุนปุ่มหมุนบนตัวเครื่องหรือใช้ล้อปรับลดตามตัวมีोजับ\*
- 7 ปรับพลังการดูดฝุ่น (รุ่นที่มีรีโมทควบคุม): กดปุ่ม +/- บนมีोजับ ตัวระบุสัญลักษณ์และพลังต่ำ/สูงบนแผงแป้นจะแสดงระดับพลังการทำงาน\*
- 8 ปรับพลังการดูดฝุ่น (รุ่นที่มีรีโมทควบคุมพร้อมโหมด AUTO): เครื่องดูดฝุ่นจะเริ่มทำงานในโหมด AUTO (กำหนดพลังการดูดฝุ่นอัตโนมัติ) ตัวระบุการทำงานแบบ AUTO จะมีไฟสว่างขึ้นบนแผงแป้น และไฟแสดงระดับพลังต่ำ/สูงจะกะพริบ หากต้องการกำหนดพลังการดูดฝุ่นด้วยตนเอง กดปุ่ม +/- บนมีोजับ กดปุ่ม AUTO เพื่อกลับไปยังฟังก์ชันการทำงานอัตโนมัติ\*
- 9 หลังจากการทำความสะอาด กดปุ่ม REWIND เพื่อดึงสายเก็บกลับเข้าที่

**ตำแหน่งการเก็บเครื่อง**

- 10 ใช้ตำแหน่งการเก็บเครื่องในด้าน (A) หรือภายใต้ (C) เพื่อแขวนและเก็บเครื่องดูดฝุ่น ที่ด้านหลัง (B) เมื่อคุณหยุดใช้งานเครื่อง (ช่วยให้ไม่ปัดหลัง)

**เปลี่ยนถุงเก็บฝุ่น S-BAG®**

- 11 เปลี่ยนถุงเก็บฝุ่น s-bag เมื่อ
  - **P\* รุ่นที่มีปุ่มหมุน:** ตัวระบุ S-BAG มีไฟสีแดงสว่างขึ้น
  - **Q\* รุ่นที่มีรีโมทควบคุม:** สัญลักษณ์ S-BAG มีไฟสีแดงสว่างขึ้น
  - **R\* รุ่นที่มีรีโมทควบคุมและโหมด AUTO:** ตัวระบุ S-BAG มีไฟสีแดงสว่างขึ้น (ไฟสีเขียว: ถังเก็บฝุ่นปกติ, ไฟสีเหลือง: ต้องเปลี่ยนถุงเก็บฝุ่น

**เร็ว นี้)**

หมายเหตุ: เปลี่ยนถุงเก็บฝุ่น s-bag อยู่เสมอเมื่อตัวระบุ S-BAG มีไฟสว่างหรือมีไฟสีแดง แม้ว่าถุงเก็บฝุ่น s-bag ยังไม่เต็มก็ตาม (เนื่องจากอาจอุดตันในบางครั้ง) และเปลี่ยนถุงเก็บฝุ่นหลังจากดูดพรอทที่ใช้ผงทำความสะอาด เพื่อประสิทธิภาพการทำงานที่ดีที่สุดที่เป็นไปได้ ให้ใช้ถุงเก็บฝุ่นขนาดยาวเป็นพิเศษซึ่งพัฒนามาเฉพาะสำหรับเครื่องดูดฝุ่นของคุณ สามารถใช้ถุงเก็บฝุ่น s-bag แบบสังเคราะห์อื่นๆ ได้เช่นกัน ห้ามใช้ถุงเก็บฝุ่นแบบกระดาษเด็ดขาด! [www.s-bag.com](http://www.s-bag.com)

- 12 กดและดึงปุ่ม S-BAG เพื่อเปิดฝาปิดส่วนเก็บฝุ่นออก มีोजับของที่ยึดถุงเก็บฝุ่น s-bag จะโผล่ขึ้นมา ดึงมีोजับขึ้นมาพร้อมที่ยึดเพื่อเปลี่ยนถุงเก็บฝุ่น s-bag อย่างนุ่มนวล
  - 13 ถือที่ยึดพร้อมถุงเก็บฝุ่น s-bag ไว้เหนือถังขยะ กดปุ่มเพื่อปลดล็อกถุงเก็บฝุ่น s-bag ใส่ถุงเก็บฝุ่น s-bag ใหม่ใหม่เข้ากับที่ยึดโดยการใส่กระดาษแข็งไว้ที่ด้านหลังของที่ยึด
  - 14 ใส่ถุงเก็บฝุ่น s-bag เข้ากับที่ยึดแล้วกดลงไปให้เข้าที่ ตรวจสอบให้แน่ใจว่าถุงเก็บฝุ่น s-bag ไม่ติดค้างอยู่ที่ยึด จากนั้นปิดฝาครอบ หากไม่ใส่ถุงเก็บฝุ่นลงไปหรือถุงเก็บฝุ่น s-bag ไม่เข้าที่ดี ฝาครอบจะปิดไม่ลง
- หมายเหตุ:** เมื่อคุณเริ่มใช้งานเครื่องดูดฝุ่นหลังจากการเปลี่ยนถุงเก็บฝุ่น s-bag จะใช้เวลา 10 วินาทีก่อนที่ไฟตัวระบุ S-BAG จะดับลง (P\* รุ่นที่มีปุ่มหมุนและ Q\* รุ่นที่มีรีโมทควบคุมและโหมด AUTO) หรือเปลี่ยนเป็นไฟสีเขียว (R\* รุ่นที่มีรีโมทควบคุมและโหมด AUTO)

**การเปลี่ยนตัวกรอง**

- 15 เปลี่ยน/ทำความสะอาด\*\*ตัวกรองเมื่อ (\*\*ตัวกรองที่สามารถล้างได้เท่านั้น)
    - **P\* รุ่นที่มีปุ่มหมุน:** คุณได้เปลี่ยนถุงเก็บฝุ่น s-bag มาแล้ว 5 ครั้ง
    - **Q\* รุ่นที่มีรีโมทควบคุม:** สัญลักษณ์ FILTER มีไฟสีแดงสว่างขึ้น
    - **R\* รุ่นที่มีรีโมทควบคุมและโหมด AUTO:** ตัวระบุตัวกรองมีไฟสีแดงสว่างขึ้น ไฟสีเขียวหมายถึงตัวกรองปกติ ซึ่งไฟจะสว่างขึ้นเพียงครู่เมื่อคุณเริ่มใช้งานเครื่องดูดฝุ่น
  - 16 กดและดึงปุ่ม FILTER ขึ้นเพื่อเปิดฝาครอบตัวกรอง ใช้ตัวกรอง s-filters ของแท้ ถอดตัวกรองและตรวจสอบตัวอ้างอิงที่แผงตัวกรองเพื่อดูประเภทเปลี่ยนตัวกรองใหม่หรือทำความสะอาดตัวกรอง\*\* เปิดน้ำอุ่นจากก๊อกล้างทางด้านใน (ด้านที่สกปรก) สะบัดน้ำออกจากแผงตัวกรอง ทำซ้ำขั้นตอนเดิม 4 ครั้ง (\*\*สำหรับตัวกรองที่ล้างน้ำได้เท่านั้น)
- หมายเหตุ: ห้ามใช้น้ำยาทำความสะอาด หลีกเลี่ยงการสัมผัสพื้นผิวของตัวกรอง ปล่อยให้ตัวกรองแห้งสนิท (อย่างน้อย 24 ชม. ในอุณหภูมิห้อง) ก่อนใส่ตัวกรองกลับเข้าที่ ! เปลี่ยนตัวกรองที่สามารถล้างได้อย่างน้อยปีละครั้งหรือเปลี่ยนตัวกรองเมื่อสกปรกหรือลึกลับหรือ ห้ามถอดแผ่นโฟมรูปตัว L ที่อยู่ใต้ตัวกรองออก
- 17 หลังจากเปลี่ยนตัวกรองแล้ว ให้ปิดฝาครอบตัวกรองจนล็อกกลับเข้าที่ หากฝาครอบตัวกรองเผยออกมาก ให้ปิดฝาครอบจากด้านใต้และดันฝาครอบตัวกรองให้ปิดจนกว่าจะล็อกกลับเข้าที่
- หมายเหตุ: เมื่อคุณเริ่มใช้งานเครื่องดูดฝุ่นหลังจากการเปลี่ยนตัวกรอง จะใช้เวลา 10 วินาทีก่อนที่ไฟตัวระบุ FILTER จะเปลี่ยนเป็นสีเขียว (รุ่นที่มีรีโมทควบคุมและฟังก์ชันการทำงาน AUTO)หรือไฟจะดับลง (รุ่นที่มีรีโมทควบคุม)\*
- 18 เปลี่ยนตัวกรองเครื่องดูดฝุ่นเมื่อสกปรกหรือเปลี่ยนหลังจากใช้ถุงเก็บฝุ่น s-bag ไปแล้ว 5 ครั้งทุกครั้ง กดที่ยึดตัวกรองลงและดึงออกมา เปลี่ยนตัวกรองและปิดฝาครอบ

**ดูดฝุ่นด้วยหัวดูดแบบมาตรฐาน (V\*, W\*)**

- 19 เปลี่ยนหัวดูดโดยใช้ปุ่มเหยียบ ไอคอนแสดงถึงประเภทพื้นที่แนะนำ
- 20 หัวดูด FlowMotion LED (high)\*: เคลื่อนหัวดูดไปข้างหน้า ไฟด้านหน้าจะสว่างขึ้นอัตโนมัติหลังจากสองถึงสามวินาที เมื่อไม่ได้ใช้หัวดูด ไฟจะดับลงอัตโนมัติหลังจากสองถึงสามวินาที

**การทำความสะอาดหัวดูดแบบมาตรฐาน (V\*, W\*)**

- 21 ถอดหัวดูดออกจากท่อดูด ทำความสะอาดด้วยมีोजับสายยาง

**การทำความสะอาดหัวดูด TURBO (X\*)**

- 22 ถอดหัวดูดออกจากท่อดูดและนำเส้นฝุ่นต่างๆ ที่พันกันออกไปโดยใช้กรรไกรตัดออก ใช้มีोजับสายยางทำความสะอาดหัวดูด\*

**อุปกรณ์เสริม 3IN1**







- 23 ดึงแกนหลังเครื่องออกมาเพื่อนำอุปกรณ์ 3in1 ออกมา อุปกรณ์มีฟังก์ชันการทำงาน 3 อย่าง ดูรูปในหน้าต่อไป
- 24 หลังการใช้งาน ให้ใส่อุปกรณ์กลับเข้าที่ตามเดิม

**การเปลี่ยนแบตเตอรี่\***

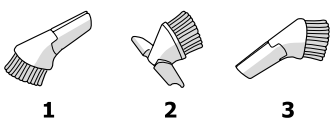
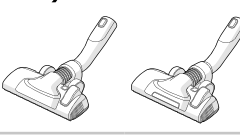
- 25** หัวดูดที่มีไฟด้านหลัง\*: เปลี่ยนแบตเตอรี่เมื่อไฟด้านหลังเริ่มกะพริบถี่ขึ้น ใช้แบตเตอรี่ AA 2 ก้อน
- 26** มือจับที่มีรีโมทควบคุม\*: เปลี่ยนแบตเตอรี่เมื่อตัวระบุมีไฟเปลี่ยนเป็นสีแดงหรือกะพริบใดๆ แล้วไม่มีการตอบสนอง ให้ใช้แบตเตอรี่ประเภท LITHIUM CR1632 เท่านั้น
- หมายเหตุ: ถอดแบตเตอรี่ออกจากเครื่องก่อนนำไปทิ้ง ปฏิบัติตามหลักเกณฑ์ในการเก็บแบตเตอรี่และอุปกรณ์ไฟฟ้าที่กำหนดในประเทศของคุณ
- ขอให้สนุกกับประสบการณ์การทำความสะดวกด้วยเครื่องดูดฝุ่น PURED9!

อิเล็กทรอนิกส์ส่วนบุคคลในการเปลี่ยนแปลงผลิตภัณฑ์ ข้อมูล และข้อมูลจำเพาะโดยไม่ต้องแจ้งให้ทราบล่วงหน้า

**เคล็ดลับการใช้งานเพื่อผลลัพธ์สูงสุด**

หัวดูด/อุปกรณ์เสริม	ใช้สำหรับ:	หัวดูด/อุปกรณ์เสริม	ใช้สำหรับ:
<b>K. อุปกรณ์เสริม 3in1*</b> 	<b>3 การใช้งานใน 1 ชั้น:</b> 1. อุปกรณ์เปิดฝุ่นสำหรับพื้นผิวแข็ง (ชั้นวางหนังสือ, แผ่นกระดาน ฯลฯ) 2. อุปกรณ์ทำความสะอาดผ้าหรือเครื่องหนัง (ผ้าผาน, เครื่องหนังหรือผ้า ฯลฯ) 3. เครื่องมือทำความสะอาดร่องพื้นที่แคบ (หลังระแนง ฯลฯ)	<b>V. หัวดูด FlowMotion* W. หัวดูด FlowMotion LED (high) (มีไฟด้านหลัง)*</b> 	<b>หัวดูดแบบมาตรฐาน:</b> - สำหรับพื้นทุกประเภท, ใช้ดูดฝุ่นได้ดีที่สุดทั้งกับพรมและพื้นเนื้อแข็ง - เปลี่ยนหัวดูดโดยใช้ปุ่มเหยียบ ไอคอนจะแสดงประเภทพื้นที่แนะนำ - ไฟด้านหลังจะช่วยตรวจจับฝุ่นและสิ่งสกปรกในพื้นที่มืด (ใต้เฟอร์นิเจอร์ ฯลฯ) หัวดูด FlowMotion LED (high) เท่านั้น
<b>X. หัวดูด Turbo*</b> 	<b>หัวดูดสำหรับพรม:</b> - ช่วยทำความสะอาดและดูดฝุ่นใต้ในคราวเดียว (กำจัดเส้นผม, เส้นด้าย ฯลฯ) - แปรงลูกกลิ้งขับเคลื่อนโดยพลังลมของเครื่องดูดฝุ่น - ไม่เหมาะสำหรับพรมที่หนาและมีขนยาว พรมกันลื่นเช่นพรมหน้าประตูหรือพรมกันน้ำ ให้ใช้หัวดูดแบบมาตรฐานแทน	<b>Y. หัวดูด Mini Turbo*</b> 	<b>หัวดูดสำหรับผ้าและเครื่องหนัง:</b> - ช่วยทำความสะอาดและดูดฝุ่นใต้ในคราวเดียว (กำจัดเส้นผม, เส้นด้าย ฯลฯ) - สำหรับเฟอร์นิเจอร์ผ้าหรือหนัง, เบาะรถ, พุก ฯลฯ - แปรงลูกกลิ้งขับเคลื่อนโดยพลังลมของเครื่องดูดฝุ่น - ไม่เหมาะสำหรับพรมที่หนาและมีขนยาว เนื่องจากจะทำให้เข้าไปติดพันกับแปรงลูกกลิ้งที่กำลั้งหมุน
<b>Z. หัวดูด ParkettoPro*</b> 	<b>หัวดูดสำหรับพื้นเนื้อแข็ง:</b> - สำหรับทำความสะอาดพื้นเนื้อแข็งอย่างนุ่มนวล (ปาร์เกต์, พื้นไม้, กระเบื้อง ฯลฯ) - กำจัดฝุ่นบนพื้นเนื้อแข็งที่มีร่องใต้ดี	<b>AA. หัวดูด FlexProPlus*</b> 	<b>หัวดูดสำหรับพื้นเนื้อแข็ง:</b> - สำหรับดูดทำความสะอาดใต้/ระหว่างเฟอร์นิเจอร์ มุมและบริเวณที่มีสิ่งกีดขวางต่างๆ - สามารถหมุนได้ 180 องศาได้อย่างง่ายดายเพื่อเข้าทำความสะอาดพื้นที่แคบได้โดยตรง
<b>AB. หัวดูดปากแฉกตัวยาว*</b> 	<b>อุปกรณ์ขนาดยาวเป็นพิเศษ:</b> - สำหรับพื้นที่ทำความสะอาดที่ยาก (ชั้นวางของด้านบนสุด ฯลฯ) - สำหรับทำความสะอาดพื้นที่แคบ (หลังระแนง, ใต้เบาะรถ ฯลฯ)		

<p><b>รุ่นที่มีการกำหนดพลังการทำงานแบบแมนนวล</b> - ปฏิบัติตามภาพกราฟิกของเครื่องดูดฝุ่นเพื่อการทำงานที่มีประสิทธิภาพสูงสุด</p>	<p><b>รุ่นที่มีฟังก์ชันการทำงาน AUTO ที่ปรับพลังการดูดฝุ่นอัตโนมัติ</b> เพื่อให้มีประสิทธิภาพการทำงานทำความสะอาดสูงสุดและอำนวยความสะดวกให้การทำความสะอาดทุกพื้นผิว สำหรับการกำหนดแบบแมนนวล ให้ปฏิบัติตามภาพกราฟิกเพื่อการทำงานที่มีประสิทธิภาพสูงสุด</p>
--	--

**การแก้ไขปัญหาเบื้องต้น**

ปัญหา	วิธีแก้ไข
เครื่องดูดฝุ่นไม่ทำงาน	<ul style="list-style-type: none"> <li>ตรวจสอบว่าเสียบสายไฟเข้ากับเต้ารับดีแล้ว</li> <li>ตรวจสอบว่าไม่มีการชำรุดเสียหายบริเวณปลั๊กไฟและสายไฟ</li> <li>ตรวจสอบว่าไม่มีฟิวส์ขาด</li> <li>ตรวจสอบว่าไฟตัวระบุแบตเตอรี่ในมือจับที่มีรีโมทควบคุมตอบสนองการทำงาน (เฉพาะบางรุ่นเท่านั้น)</li> </ul>
ไฟตัวระบุ s-bag® สว่างขึ้น	<ul style="list-style-type: none"> <li>ตรวจสอบว่าถุงเก็บฝุ่น s-bag® ไม่เต็มหรืออุดตัน</li> <li>หากคุณได้เปลี่ยนถุงเก็บฝุ่น s-bag® แล้ว ให้เปลี่ยนตัวกรองเครื่องดูดฝุ่น</li> </ul>
ไฟตัวระบุตัวกรองสว่างขึ้น (เฉพาะบางรุ่นเท่านั้น)	เปลี่ยนหรือล้าง (หากสามารถล้างได้) ตัวกรองที่สึกหรอ
เครื่องดูดฝุ่นหยุดทำงาน	เครื่องดูดฝุ่นอาจร้อนเกินไป: ถอดปลั๊กเครื่องดูดฝุ่นออก ตรวจสอบว่าหัวดูด ทอดดูดฝุ่น สายยางหรือตัวกรองอุดตันหรือไม่ ให้เครื่องดูดฝุ่นหยุดทำงานเพื่อให้เครื่องเย็นลงเป็นเวลา 30 นาที ก่อนเสียบปลั๊กเพื่อใช้งานอีกครั้ง หากเครื่องดูดฝุ่นยังคงไม่ทำงาน ให้ติดต่อศูนย์บริการอิเล็กทรอนิกส์ที่ได้รับอนุญาต
มีการดูดฝุ่นได้น้อยลงเทียบกับปกติ	<ul style="list-style-type: none"> <li>ตรวจสอบในกรณีที่ถุงเก็บฝุ่น s-bag® เต็มหรืออุดตัน</li> <li>ตรวจสอบในกรณีที่ตัวกรองเครื่องดูดฝุ่นอุดตันและต้องทำการเปลี่ยน</li> <li>ตรวจสอบในกรณีที่หัวดูดอุดตันและต้องทำความสะอาด</li> <li>ตรวจสอบในกรณีที่สายยางอุดตันโดยคราบคอก อายูบ บีบเบาๆ อย่างไรก็ตาม โปรดระมัดระวังในกรณีที่การอุดตันเกิดจากเศษแก้วหรือเข็มที่อยู่ภายในสายยาง</li> </ul> หมายเหตุ: การรับประกันไม่ได้ครอบคลุมความเสียหายใดๆ ของสายยางที่เกิดจากการทำความสะอาดสายยาง
เครื่องดูดฝุ่นดูดน้ำเข้าไปในตัวเครื่อง	จำเป็นต้องเปลี่ยนมอเตอร์ ณ ศูนย์บริการอิเล็กทรอนิกส์ที่ได้รับอนุญาต น้ำที่ไหลเข้ามาจะสร้างความเสียหายให้กับมอเตอร์ ซึ่งไม่อยู่ภายใต้การรับประกัน
<b>สำหรับปัญหาอื่นๆ ที่พบ โปรดติดต่อศูนย์บริการอิเล็กทรอนิกส์ที่ได้รับอนุญาต</b>	

## ข้อควรระวังเพื่อความปลอดภัย

เด็กที่อายุตั้งแต่ 8 ปีขึ้นไปและบุคคลผู้มีความบกพร่องทางร่างกาย ทางประสาทสัมผัสหรือทางจิต หรือ ผู้ที่ขาดประสบการณ์และความรู้ สามารถใช้งานเครื่องดูดฝุ่นนี้ได้ก็ต่อเมื่ออยู่ภายใต้การดูแลหรือการแนะนำในการใช้เครื่องดูดฝุ่นด้วยวิธีการที่ปลอดภัย และตระหนักถึงอันตรายที่เกี่ยวข้อง

เด็กไม่ควรเล่นเครื่องดูดฝุ่น

อย่าปล่อยให้เด็กทำความสะอาดและซ่อมบำรุงเครื่องดูดฝุ่นด้วยตนเองโดยไม่อยู่ในความดูแลของผู้ใหญ่

**คำเตือน:** หัวดูด Turbo\* มีแปรงหมุนซึ่งอาจทำให้มีชิ้นส่วนต่างๆ เข้าไปเกี่ยวติดได้ โปรดใช้งานด้วยความระมัดระวังและใช้งานเฉพาะกับพื้นผิวที่ระบุเท่านั้น โปรดปิดใช้งานเครื่องดูดฝุ่นก่อนจะนำเอาชิ้นส่วนต่างๆ ที่ติดอยู่ภายในออกหรือก่อนจะทำความสะอาดแปรง

ต้องถอดแบตเตอรี่ออกจากรีโมทควบคุมที่อยู่บนมือจับ\* / หัวดูดที่มีไฟ LED\* ก่อนจะทิ้งผลิตภัณฑ์\*\*

\* ใช้กับเครื่องใช้ไฟฟ้าบางรุ่นเท่านั้น

\*\* ข้อมูลเกี่ยวกับวิธีถอดแบตเตอรี่อยู่ในแผ่นพับส่วนที่ 25 และ 26

ถอดปลั๊กออกจากเต้ารับก่อนการทำความสะอาดหรือซ่อมบำรุงเครื่องหรือเมื่อถอดแบตเตอรี่ออกจากตัวเครื่องเสมอ แบตเตอรี่ต้องนำไปทิ้งอย่างปลอดภัย

หากสายไฟชำรุด จะต้องได้รับการเปลี่ยนโดยศูนย์บริการอิเล็กทรอนิกส์ที่ได้รับอนุญาตเท่านั้น เพื่อหลีกเลี่ยงการเกิดอันตราย

ควรใช้เครื่องดูดฝุ่น PURED9 ในการทำความสะอาดสภาพแวดล้อมในร่มและภายในบ้านตามปกติเท่านั้น ตรวจสอบให้แน่ใจว่าเก็บเครื่องดูดฝุ่นไว้ในที่แห้ง บริการหรือการซ่อมบำรุงทั้งหมดจะต้องดำเนินการโดยศูนย์บริการอิเล็กทรอนิกส์ที่ได้รับอนุญาต เก็บวัสดุบรรจุภัณฑ์ทั้งหมด เช่น ถุงพลาสติก ให้ห่างจากมือเด็กเพื่อป้องกันการขาดอากาศหายใจ

### ห้ามใช้งานเครื่องดูดฝุ่น:

- ในพื้นที่เปียก
- ใกล้กับก๊าซไวไฟ ฯลฯ
- เมื่อผลิตภัณฑ์มีร่องรอยชำรุด
- ใช้ดูดของมีคมหรือของเหลว
- เมื่อหัวดูดพื้นมีร่องรอยการชำรุด
- ใช้ดูดเก้าอี้ถนร้อนหรือเย็น ก้นบูทที่ติดไฟ ฯลฯ
- ใช้ดูดฝุ่นผงละเอียด เช่น ปูนปลาสเตอร์ คอนกรีต ผงแป้ง เก้าอี้ถนร้อนหรือเย็น
- อย่าวางเครื่องดูดฝุ่นให้สัมผัสกับแสงแดดโดยตรง
- หลีกเลี่ยงการวางเครื่องดูดฝุ่นไว้ในอุณหภูมิร้อนจัดหรือเย็นจัด
- ห้ามใช้เครื่องดูดฝุ่นโดยไม่มีตัวกรอง
- อย่าสัมผัสแปรงลูกกลิ้งในขณะที่เปิดใช้งานเครื่องดูดฝุ่น และในขณะที่แปรงลูกกลิ้งหมุนอยู่
- เมื่อล้อหมุนอุดตัน

### ข้อควรระวังเกี่ยวกับสายไฟ

ตรวจสอบปลั๊กและสายไฟเป็นประจำ ห้ามใช้งานเครื่องดูดฝุ่นหากปลั๊กหรือสายไฟชำรุด การรับประกันไม่ครอบคลุมเครื่องดูดฝุ่นที่มีสายไฟชำรุด ห้ามดึงหรือยกเครื่องดูดฝุ่นโดยใช้สายไฟ การใช้งานเครื่องดูดฝุ่นในสภาวะแวดล้อมข้างต้นอาจทำให้ได้รับบาดเจ็บร้ายแรงต่อตัวบุคคลหรือทำให้ผลิตภัณฑ์ชำรุดเสียหาย ซึ่งความเสียหายในลักษณะนี้ไม่ได้ครอบคลุมอยู่ในการรับประกันหรือในขอบเขตของอิเล็กทรอนิกส์

### การให้บริการและการรับประกัน

บริการหรือการซ่อมบำรุงทั้งหมดจะต้องดำเนินการโดยศูนย์บริการอิเล็กทรอนิกส์ที่ได้รับอนุญาต การรับประกันไม่ครอบคลุมเครื่องดูดฝุ่นที่มีสายไฟชำรุด ความเสียหายของมอเตอร์ที่เกิดจากการดูดน้ำ การปล่อยให้น้ำไหลเข้าเครื่อง หรือการใช้เครื่องที่มีสายยางชำรุดเสียหาย และหัวดูดไม่ได้ใช้ในการรับประกัน ใช้ถุงเก็บฝุ่น s-bag ของแท้ที่ใช้สำหรับเครื่องดูดฝุ่นรุ่นนี้เสมอ ดูส่วนที่ 11 การรับประกันไม่ครอบคลุมความชำรุดเสียหายของเครื่องดูดฝุ่นที่เกิดจากการไม่ได้ใช้ถุงเก็บฝุ่นของแท้ที่ถูกต้อง

### การกำจัดทิ้ง

สัญลักษณ์ที่ตัวผลิตภัณฑ์นี้บ่งชี้ว่า ผลิตภัณฑ์นี้มีแบตเตอรี่ซึ่งอาจไม่สามารถกำจัดทิ้งร่วมกับขยะในครัวเรือนตามปกติได้

สัญลักษณ์ที่ตัวผลิตภัณฑ์หรือบรรจุภัณฑ์นี้บ่งชี้ว่าผลิตภัณฑ์นี้อาจไม่สามารถจัดการแบบเดียวกับขยะในครัวเรือนได้

หากต้องการรีไซเคิลผลิตภัณฑ์ โปรดนำผลิตภัณฑ์ไปส่งที่สถานที่รับคัดแยกขยะที่เป็นทางการ หรือศูนย์บริการอิเล็กทรอนิกส์ที่สามารถถอดและนำแบตเตอรี่ รวมถึงชิ้นส่วนไฟฟ้าไปรีไซเคิลได้อย่างปลอดภัยและเป็นมืออาชีพ ปฏิบัติตามหลักเกณฑ์ในการแยกเก็บอุปกรณ์ไฟฟ้าและแบตเตอรี่ชนิดชาร์จซ้ำที่กำหนดในประเทศของคุณ

Home Care และ SDA ของอิเล็กทรอนิกส์ประกาศ ณ ที่นี้ว่าเครื่องดูดฝุ่นประเภทอุปกรณ์สัญญาณวิทยุ HER2 และ HER3 เป็นไปตามกฎข้อบังคับ 2014/53/EU

### หมายเหตุสำหรับการกำหนดฉลากประหยัดพลังงาน

เครื่องดูดฝุ่นนี้เป็นเครื่องดูดฝุ่นสำหรับใช้งานโดยทั่วไป หากต้องการให้เกิดประสิทธิภาพด้านการประหยัดพลังงานและประสิทธิภาพ การทำความสะอาดที่ระบุสำหรับพรม โปรดใช้หัวดูดแบบมาตรฐาน "FlowMotion / FlowMotion LED (high)" ที่สามารถถอดเปลี่ยนได้ หากต้องการให้เกิดประสิทธิภาพการทำความสะอาดที่ระบุสำหรับพื้นเนื้อแข็งที่มีร่อง โปรดใช้หัวดูด "Parketto Pro" ที่ใช้เฉพาะกับพื้นเนื้อแข็งตามต้องการและมีให้มาในบรรจุภัณฑ์ หรือไม่ก็ใช้หัวดูดแบบมาตรฐาน "FlowMotion / FlowMotion LED (high)" ที่สามารถถอดเปลี่ยนได้ สามารถดาวน์โหลดคู่มือการใช้งาน ในแสดงข้อมูลจำเพาะของเครื่องดูดฝุ่น และฉลากประหยัดพลังงานได้จากเว็บไซต์ของเรา [www.electrolux.com](http://www.electrolux.com) การคำนวณขึ้นอยู่กับกฎระเบียบ Commission Delegated Regulation (EU) No 665/2013 ลงวันที่ 3 พฤษภาคม 2013 ซ้อย่อยเพิ่มเติม 2010/30/EU ทุกขั้นตอนในคำแนะนำเหล่านี้ที่มิได้อธิบายลงรายละเอียดที่แม่นยำเพิ่มเติมเป็นไปตามข้อกำหนด EN 60312-1:2013

## TIẾNG VIỆT

Cảm ơn bạn đã lựa chọn máy hút bụi Electrolux PURE D9. Vui lòng chỉ sử dụng các phụ tùng và phụ kiện chính hãng để máy hoạt động tốt nhất. Sản phẩm này được thiết kế có cân nhắc tới yếu tố bảo vệ môi trường. Tất cả các bộ phận bằng nhựa được đánh dấu vì mục đích tái chế.

### TRƯỚC KHI KHỞI ĐỘNG

- Đọc kỹ hướng dẫn sử dụng.
- Kiểm tra xem đã đủ các bộ phận như mô tả chưa.
- Đặc biệt lưu ý mục các biện pháp an toàn!

### MÔ TẢ VỀ MÁY HÚT BỤI PURED9

- |   |   |
|---|---|
| A. Bảng hiển thị (xem các phiên bản sau)                          | Q. Bảng hiển thị đối với các mẫu có điều khiển từ xa*                             |
| B. Nắp đậy bộ lọc   | R. Bảng hiển thị đối với các mẫu có điều khiển từ xa và chức năng AUTO (TỰ ĐỘNG)* |
| C. Bộ lọc   | S. Tay cầm AeroPro Classic*   |
| D. Rãnh dừng  | T. Tay cầm AeroPro Ergo*  |
| E. Dây điện   | U. Tay cầm AeroPro Điều khiển từ xa*  |
| F. Bộ lọc động cơ   | V. Đầu hút AeroPro FlowMotion*  |
| G. Giá giữ bộ lọc động cơ   | W. Đầu hút AeroPro FlowMotion LED (high) (có đèn phía trước)*                     |
| H. Túi lọc bụi S-bag®   | X. Đầu hút AeroPro Turbo*   |
| I. Giá giữ túi lọc bụi S-bag®                                     | Y. Đầu hút AeroPro Turbo Mini*  |
| J. Nắp đậy ngăn chứa bụi  | Z. Đầu hút ParkettoPro*   |
| K. Phụ kiện AeroPro 3 trong 1                                     | AA. Đầu hút FlexProPlus AeroPro*  |
| L. Ống dẫn AeroPro  | AB. Đầu hút AeroPro Khe hẹp loại dài*   |
| M. Tay cầm AeroPro (xem các phiên bản sau)                        |   |
| N. Ống lồng AeroPro   |   |
| O. Giá gài rãnh dừng  |   |
| P. Bảng hiển thị đối với các mẫu có núm xoay điều chỉnh bằng tay* |   |

\* Đối với những mẫu nhất định

### CÁCH SỬ DỤNG MÁY HÚT BỤI

- 1 Mở nắp đậy ngăn chứa bụi bằng cách nhấn nút túi lọc bụi S-BAG xuống. Kiểm tra xem túi lọc bụi (s-bag) đã ở đúng vị trí chưa.
- 2 Cắm ống dẫn vào máy hút bụi (để tháo, ấn vào chốt khóa và kéo ống ra). Cắm ống dẫn vào cán ống tới khi có tiếng "cách" (để tháo, ấn vào chốt khóa và kéo ống ra).
- 3 Gắn ống lồng vào đầu hút. Gắn ống lồng vào cán ống (để tháo, ấn vào chốt khóa và kéo ống ra).
- 4 Điều chỉnh ống lồng bằng cách giữ chốt khóa bằng một tay và kéo cán ống bằng tay còn lại.

### BẬT/TẮT MÁY HÚT BỤI VÀ ĐIỀU CHỈNH LỰC HÚT

- 5 Kéo dây điện ra và cắm vào nguồn điện. Ấn nút ON/OFF (BẬT/TẮT) để bật/tắt máy. Đèn báo sáng lên, đèn báo MIN/MAX (THẤP NHẤT/CAO NHẤT) nhấp liên tục từ trái sang phải (các mẫu có chức năng tự động).\* Các mẫu có điều khiển từ xa vẫn vận hành được bằng nút ON/OFF trên tay cầm.\*
- 6 Điều chỉnh lực hút (các mẫu vận hành bằng tay): Vận núm xoay trên máy hoặc dùng van khí trên tay cầm.\*
- 7 Điều chỉnh lực hút (các mẫu vận hành tự động): Ấn nút +/- trên tay cầm. Đèn báo MIN/MAX và các đèn báo biểu tượng khi sáng lên sẽ hiển thị mức lực hút.
- 8 Điều chỉnh lực hút (các mẫu vận hành từ xa có chức năng AUTO): Máy hút bụi khởi động ở chế độ AUTO (tự động điều chỉnh lực hút). Đèn báo AUTO sáng lên và đèn báo MIN/MAX nhấp nháy. Ấn nút +/- trên tay cầm để điều chỉnh lực hút. Ấn nút AUTO để trở về chế độ tự động.\*
- 9 Khi hút bụi xong, ấn nút REWIND (THU HỒI) để thu dây điện về.

### RÃNH DỪNG

- 10 Dùng rãnh dừng bên hông (A) hoặc bên dưới (C) để di chuyển và cất giữ máy hút bụi. Ở phía sau (B) khi bạn tạm dừng công việc (không phải cúi xuống).

### THAY TÚI LỌC BỤI, S-BAG®

- 11 Thay túi lọc bụi s-bag khi
  - **Mẫu P\* có núm xoay:** Đèn báo S-BAG sáng màu đỏ.
  - **Mẫu Q\* có điều khiển từ xa:** Biểu tượng S-BAG sáng màu đỏ.
  - **Mẫu R\* có điều khiển từ xa và chức năng AUTO:** Đèn báo S-BAG sáng màu đỏ (sáng màu xanh: túi lọc còn tốt, sáng màu vàng: sắp phải thay túi lọc).Lưu ý: Luôn phải thay túi lọc bụi s-bag khi đèn báo S-BAG sáng lên hoặc chuyển đỏ cho dù túi lọc bụi s-bag chưa đầy (có thể bị tắc) và sau khi sử dụng bột lau. Để cho kết quả tốt nhất, hãy sử dụng túi Ultra Long Performance được phát triển riêng cho máy hút bụi của bạn. Cũng có thể sử dụng các loại túi s-bag sợi tổng hợp khác. Không sử dụng các loại túi lọc bụi giấy! [www.s-bag.com](http://www.s-bag.com)

- 12 Nhấn nút túi lọc bụi S-BAG xuống để mở ngăn chứa bụi. Cán cầm của giá giữ s-bag hướng lên. Nhắc cán cầm để tháo túi lọc bụi s-bag cùng với giá giữ. Không ấn vào nút tháo.

- 13 Đưa túi lọc bụi s-bag cùng giá giữ ra chỗ thùng rác. Ấn nút để tháo túi lọc bụi s-bag. Thay túi lọc bụi s-bag mới vào giá giữ bằng cách gắn miếng bìa vào phía sau giá giữ.

- 14 Gắn túi lọc bụi s-bag cùng với giá giữ vào bằng cách nhấn mạnh nó vào rãnh. Đảm bảo rằng túi lọc bụi s-bag không bị kẹt phía dưới giá giữ. Đậy nắp. Nếu túi lọc bụi s-bag không được đặt đúng chỗ hoặc chưa được gắn vào thì sẽ không đóng được nắp.

Lưu ý: Khi bạn khởi động máy hút bụi sau khi thay túi lọc bụi s-bag, đèn báo S-BAG sẽ tắt sau 10 giây (Mẫu P\* có núm xoay và Mẫu Q\* có điều khiển từ xa) hoặc chuyển xanh (Mẫu R\* có điều khiển từ xa và chức năng AUTO).

### THAY BỘ LỌC

- 15 Thay thế/làm sạch\*\* bộ lọc khi (\*\*đối với các bộ lọc có thể giặt được)
  - **Mẫu P\* có núm xoay:** Bạn đã thay túi lọc bụi s-bag 5 lần.
  - **Mẫu Q\* có điều khiển từ xa:** Biểu tượng FILTER (BỘ LỌC) sáng màu đỏ.
  - **Mẫu R\* có điều khiển từ xa và chức năng AUTO:** Đèn báo bộ lọc sáng màu đỏ. Đèn xanh biểu thị bộ lọc còn tốt. Đèn sẽ sáng lên sau khi bạn khởi động máy hút bụi.
- 16 Nhấn nút FILTER xuống để mở nắp đậy bộ lọc. Sử dụng các bộ lọc s-filter chính hãng. Tháo bộ lọc và kiểm tra thông tin trên khung để xác định loại bộ lọc. Thay bộ lọc mới hoặc làm sạch bộ lọc cũ\*\*. Rửa bên trong (mặt dính bẩn) bằng nước ấm. Vỗ nhẹ vào khung bộ lọc để nước ra hết. Lặp lại các bước trên bốn lần. (\*\*đối với bộ lọc có thể rửa được)

Lưu ý: Không dùng các chất tẩy rửa. Tránh chạm vào bề mặt bộ lọc. Phơi khô bộ lọc (tối thiểu 24 tiếng ở nhiệt độ phòng) trước khi gắn lại vào máy! Thay bộ lọc có thể rửa được ít nhất một lần mỗi năm hoặc khi nó quá bẩn hoặc bị hỏng. Không tháo đệm chữ L phía dưới bộ lọc.

- 17 Sau khi thay bộ lọc, đóng nắp đậy bộ lọc đến khi có tiếng "cách". Nếu nắp đậy bộ lọc rời ra, chỉnh lại các bản lề dưới đáy và ấn nắp đậy bộ lọc đến khi có tiếng "cách".

Lưu ý: Khi bạn khởi động máy hút bụi sau khi thay bộ lọc, đèn báo FILTER sẽ chuyển xanh sau 10 giây (các mẫu có điều khiển từ xa và chức năng AUTO) hoặc tắt đi (các mẫu có điều khiển từ xa).\*

- 18 Thay bộ lọc động cơ khi bẩn hoặc sau mỗi 5 lần thay túi lọc bụi s-bag. Ấn giá giữ bộ lọc xuống và kéo nó ra. Thay bộ lọc và đóng nắp lại.

### HÚT BỤI VỚI ĐẦU HÚT ĐA NĂNG (V\*, W\*)

- 19 Đối cài đặt đầu hút bằng bàn đạp. Các biểu tượng minh họa loại sàn được khuyến nghị.
- 20 Đầu hút FlowMotion LED (high)\*: Di chuyển đầu hút về phía trước. Đèn trước tự động sáng lên sau vài giây. Khi không sử dụng đầu hút, đèn sẽ tự động tắt sau vài giây.

### LAU DỌN VỚI ĐẦU HÚT ĐA NĂNG (V\*, W\*\*)

- 21 Tháo đầu hút khỏi ống. Làm sạch bằng cán ống.

### LÀM SẠCH ĐẦU HÚT TURBO (X\*)

- 22 Tháo đầu hút khỏi ống và loại bỏ các loại sợi dính vào bằng cách dùng kéo cắt ra. Dùng cán ống để làm sạch đầu hút.\*

**PHỤ KIỆN 3 TRONG 1**

- 23 Kéo miếng vải để lấy ra phụ kiện 3 trong 1. Phụ kiện có 3 chức năng, vui lòng xem ảnh ở trang tiếp.
- 24 Sau khi dùng xong, đặt nó vào lại vị trí cũ.

**THAY PIN\***

- 25 Đầu hút có đèn phía trước\*: Thay pin khi đèn trước bắt đầu nhấp nháy nhanh. Sử dụng pin 2 AA.





- 26 Tay cầm có điều khiển từ xa\*: Thay pin khi đèn báo chuyển đỏ hoặc không phản hồi khi ấn nút. Chỉ sử dụng pin loại LITHIUM CR1632.

Lưu ý: Tháo pin khỏi sản phẩm trước khi vứt. Tuân thủ các quy định của quốc gia sở tại về thu gom riêng các loại pin và sản phẩm điện.

**Tận hưởng trải nghiệm vệ sinh tuyệt vời với PURED9!**

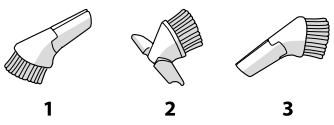
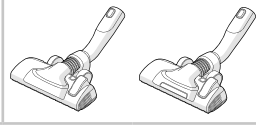
Electrolux có quyền thay đổi sản phẩm, thông tin và các thông số kỹ thuật mà không cần phải thông báo.

**BÍ QUYẾT SỬ DỤNG HIỆU QUẢ NHẤT**

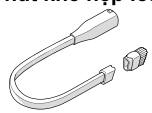
ĐẦU HÚT/PHỤ KIỆN	DÙNG CHO:	ĐẦU HÚT/PHỤ KIỆN	DÙNG CHO:
<p><b>K. Phụ kiện 3 trong 1*</b></p> 	<p><b>3 phụ kiện trong 1:</b></p> <ol style="list-style-type: none"> <li>1. Phụ kiện hút bụi dành cho các mặt phẳng cứng (giấy sách, ván ốp chân tường, v.v.).</li> <li>2. Phụ kiện đệm dành cho các chất liệu vải (rèm cửa, đệm ghế, v.v.).</li> <li>3. Phụ kiện đầu nhỏ dành cho các không gian hẹp (đăng sau bộ tản nhiệt, v.v.).</li> </ol>	<p><b>V. Đầu hút FlowMotion*</b> <b>W. Đầu hút FlowMotion LED (high) (có đèn phía trước)*</b></p> 	<p><b>Đầu hút đa năng:</b></p> <ul style="list-style-type: none"> <li>- Dành cho mọi loại sàn, đảm bảo hút sạch bụi trên cả thảm và sàn cứng.</li> <li>- Đổi cài đặt đầu hút bằng bàn đạp. Biểu tượng minh họa loại sàn được khuyến nghị.</li> <li>- Đèn trước giúp phát hiện bụi bẩn ở các khu vực tối (bên dưới đồ nội thất, v.v.). <i>Chỉ dành cho Đầu hút FlowMotion LED (high)</i></li> </ul>
<p><b>X. Đầu hút Turbo*</b></p> 	<p><b>Đầu hút thảm:</b></p> <ul style="list-style-type: none"> <li>- Trải và hút cùng lúc (phù hợp nhất để hút tóc, các loại sợi, v.v.).</li> <li>- Chổi lăn xoay theo luồng khí thổi của máy hút bụi.</li> <li>- Không phù hợp với các loại thảm có lông nhung rậm và mềm dài, các loại thảm chống trượt như thảm chùi chân hoặc thảm chống nước. Trong trường hợp này, hãy dùng đầu hút đa dụng.</li> </ul>	<p><b>Y. Đầu hút Turbo Mini*</b></p> 	<p><b>Đầu hút đệm:</b></p> <ul style="list-style-type: none"> <li>- Trải và hút cùng lúc (phù hợp nhất để hút tóc, các loại sợi, v.v.).</li> <li>- Dành cho đồ nội thất bọc vải, ghế ô tô, đệm, v.v.</li> <li>- Chổi lăn xoay theo luồng khí thổi của máy hút bụi.</li> <li>- Không phù hợp với các loại thảm có lông nhung rậm và mềm dài vì lông có thể kẹt lại trong chổi lăn.</li> </ul>
<p><b>Z. Đầu hút ParkettoPro*</b></p> 	<p><b>Đầu hút sàn cứng:</b></p> <ul style="list-style-type: none"> <li>- Dùng để lau nhẹ sàn cứng (sàn lát gỗ, sàn gỗ, sàn lát gạch, v.v.).</li> <li>- Phù hợp hút bụi nhất trên sàn cứng có khe hở.</li> </ul>	<p><b>AA. Đầu hút FlexProPlus*</b></p> 	<p><b>Đầu hút sàn cứng:</b></p> <ul style="list-style-type: none"> <li>- Dùng để hút bụi phía dưới/giữa các đồ nội thất, các góc và các chướng ngại vật khác.</li> <li>- Có thể xoay 180 độ để dễ dàng giúp tiếp cận trực tiếp các không gian hẹp.</li> </ul>
<p><b>AB. Đầu hút khe hẹp loại dài*</b></p> 	<p><b>Phụ kiện siêu dài:</b></p> <ul style="list-style-type: none"> <li>- Dành cho các khu vực khó với tới (nóc tủ, v.v.).</li> <li>- Dành cho các không gian hẹp (đăng sau bộ tản nhiệt, dưới ghế ô tô, v.v.).</li> </ul>		

**Các mẫu điều chỉnh lực hút bằng tay**  
– thực hiện theo các minh họa trên máy hút bụi để tối ưu hiệu quả sử dụng.

**Các mẫu có chức năng AUTO tự động điều chỉnh lực hút**  
nhằm mang lại hiệu quả làm sạch tối ưu và sự thoải mái khi dùng máy trên mọi bề mặt. Để điều chỉnh bằng tay, thực hiện theo các minh họa để tối ưu hiệu quả sử dụng.

**KHẮC PHỤC SỰ CỐ**

SỰ CỐ	GIẢI PHÁP
Máy hút bụi không hoạt động	<ul style="list-style-type: none"> <li>• Kiểm tra xem dây điện đã nối với nguồn điện chưa.</li> <li>• Kiểm tra xem phích cắm và dây điện có bị hỏng không.</li> <li>• Kiểm tra xem cầu tri có bị nổ không.</li> <li>• Kiểm tra xem đèn báo mức pin ở tay cầm điều khiển từ xa có phản hồi không (đối với những mẫu nhất định).</li> </ul>
Đèn báo s-bag® sáng lên	<ul style="list-style-type: none"> <li>• Kiểm tra xem s-bag® có đầy hoặc bị kẹt không.</li> <li>• Nếu bạn mới thay s-bag®, hãy thay bộ lọc động cơ.</li> </ul>
Đèn báo bộ lọc sáng lên (đối với những mẫu nhất định)	Thay hoặc giặt (nếu có thể giặt) bộ lọc.
Máy hút bụi ngừng chạy	Máy hút bụi có thể bị quá nóng; rút ra khỏi nguồn điện; kiểm tra xem đầu hút, ống lồng, ống dẫn hoặc bộ lọc có bị tắc không. Để máy hút bụi nguội đi khoảng 30 phút trước khi cắm lại. Nếu máy hút bụi vẫn không hoạt động, liên hệ trung tâm dịch vụ được ủy quyền của Electrolux.
Giảm công suất hút so với bình thường	<ul style="list-style-type: none"> <li>• Kiểm tra xem s-bag® có đầy hoặc bị kẹt không.</li> <li>• Kiểm tra xem bộ lọc động cơ có bị nghẽn và cần thay không.</li> <li>• Kiểm tra xem đầu hút có bị tắc và cần làm sạch không.</li> <li>• Kiểm tra xem ống dẫn có bị tắc không bằng cách bóp nhẹ ống. Tuy nhiên, hãy cẩn thận trong trường hợp vật gây tắc bên trong ống là mảnh kính hoặc kim.</li> </ul> <p>Lưu ý: Hư hại cho ống gây ra bởi việc làm sạch ống không được bảo hành.</p>
Nước bị hút vào máy hút bụi.	Cần thay thế động cơ tại trung tâm dịch vụ được ủy quyền của Electrolux. Hư hỏng động cơ do sự xâm nhập của nước không được bảo hành.
<b>Nếu phát sinh vấn đề khác, liên hệ trung tâm dịch vụ được ủy quyền của Electrolux.</b>	

## CÁC BIỆN PHÁP AN TOÀN

Trẻ em từ 8 tuổi trở lên và những người có khuyết tật về thể chất, giác quan hoặc thần kinh hoặc thiếu kinh nghiệm và kiến thức chỉ được phép sử dụng thiết bị này nếu được giám sát hoặc chỉ dẫn sử dụng một cách an toàn và họ hiểu rõ các mối nguy hiểm liên quan.

Không để trẻ em nghịch thiết bị này.

Không để trẻ em vệ sinh và bảo trì thiết bị khi không có người giám sát.

**CẢNH BÁO:** Đầu hút Turbo\* có chổi xoay nên các vật nhỏ có thể kẹt vào. Vui lòng sử dụng đầu hút cẩn thận và chỉ dùng trên các mặt phẳng được khuyến nghị. Vui lòng tắt máy hút bụi trước khi loại bỏ các vật nhỏ bị kẹt hay làm sạch chổi.

Phải tháo pin khỏi bộ phận điều khiển từ xa ở tay cầm\*/đầu hút đèn LED\* trước khi vứt sản phẩm\*\*.

*\*Đối với những mẫu nhất định.*

\*\*Thông tin hướng dẫn tháo pin nằm tại phần gấp lại giữa phần 25 và 26.

Luôn tháo dây khỏi nguồn điện trước khi làm sạch hoặc bảo trì thiết bị hay khi tháo pin. Pin phải được tiêu hủy an toàn.

Nếu dây điện bị hư hại, phải thay dây tại trung tâm dịch vụ được ủy quyền của Electrolux để tránh nguy hiểm.

Chỉ nên sử dụng PURE D9 để hút bụi thông thường ở môi trường trong nhà. Đảm bảo máy hút bụi được bảo quản ở nơi khô ráo. Mọi công việc bảo dưỡng hoặc sửa chữa thiết bị phải do trung tâm dịch vụ được ủy quyền của Electrolux thực hiện. Không để các vật liệu đóng gói như túi nhựa gần tầm tay trẻ em để tránh gây ngạt thở.

### Không sử dụng máy hút bụi:

Ở khu vực ẩm ướt.

Gần các loại khí dễ cháy, v.v..

Khi sản phẩm có dấu hiệu hư hỏng rõ ràng.

Trên các vật sắc nhọn hoặc chất lỏng.

Khi đầu hút sàn có dấu hiệu hư hỏng rõ ràng.

Trên xỉ than nóng hoặc nguội, mẩu thuốc lá đang cháy, v.v..

Trên bụi mịn, như thạch cao, bê tông, bột mì, xỉ than nóng hoặc nguội.

Không để máy hút bụi tiếp xúc trực tiếp với ánh nắng mặt trời.

Tránh để máy hút bụi tiếp xúc với nguồn nhiệt mạnh hoặc nguồn lạnh dưới mức đóng băng.

Không sử dụng máy hút bụi khi không có bộ lọc.

Không được chạm vào chổi lăn khi máy hút bụi đang bật và chổi lăn đang xoay.

Khi các bánh xe bị kẹt.

### Các biện pháp an toàn cho dây điện

Thường xuyên kiểm tra phích cắm và dây điện. Tuyệt đối không sử dụng máy hút bụi khi phích cắm hoặc dây điện bị hỏng.

Hư hại đối với dây điện của máy hút bụi không được bảo hành.

Tuyệt đối không kéo hoặc nâng máy hút bụi bằng dây điện.

Sử dụng máy hút bụi trong các trường hợp trên có thể gây thương tích nghiêm trọng hoặc làm hỏng máy hút bụi. Thương tích hoặc hư hỏng do không tuân thủ các khuyến cáo này không thuộc phạm vi bảo hành của Electrolux.

### BẢO DƯỠNG VÀ BẢO HÀNH

Mọi công tác bảo dưỡng hoặc sửa chữa thiết bị phải do trung tâm dịch vụ được ủy quyền của Electrolux thực hiện.

Hư hại gây ra với dây điện của máy hút bụi không được bảo hành.

Hư hại động cơ do hút phải chất lỏng, ngâm thiết bị trong chất lỏng hoặc sử dụng thiết bị khi ống dẫn và đầu hút bị hỏng đều không được bảo hành.

Chỉ sử dụng túi lọc bụi s-bag chính hãng tương thích với loại máy hút bụi này, vui lòng xem phần 11. Hư hỏng đối với máy hút bụi do sử dụng túi lọc bụi không chính hãng không được bảo hành.

### TIÊU HỦY

Biểu tượng này trên sản phẩm cho biết sản phẩm có chứa pin và pin này không được phép tiêu hủy cùng rác thải sinh hoạt.

Biểu tượng này trên sản phẩm hoặc bao bì sản phẩm cho biết không được xử lý sản phẩm này như rác thải sinh hoạt.

Để tái chế sản phẩm, vui lòng đưa sản phẩm đến điểm thu gom chính thức hoặc trung tâm dịch vụ của Electrolux, nơi có thể tháo và tái chế pin cũng như các bộ phận điện tử một cách an toàn và chuyên nghiệp. Tuân thủ các quy định tại quốc gia sở tại về thu gom riêng các sản phẩm điện và pin sạc.

Electrolux Home Care và SDA tuyên bố rằng Máy hút bụi loại sử dụng sóng radio HER2 và HER3 tuân thủ Chỉ thị 2014/53/EU.

### LƯU Ý VỀ QUY TẮC DÁN NHÃN NĂNG LƯỢNG

Máy hút bụi này là máy hút bụi sử dụng cho mục đích thông thường. Để đạt mức tiết kiệm năng lượng và hiệu quả làm sạch mong đợi đối với thảm, vui lòng sử dụng đầu hút đa năng có thể thay thế "FlowMotion / FlowMotion LED (high)".

Để đạt hiệu quả làm sạch mong đợi đối với các khe hẹp, vui lòng sử dụng đầu hút chuyên dụng cho sàn cứng "Parketto Pro" nếu có thông tin quy định trên bao bì, nếu không, hãy sử dụng đầu hút đa năng có thể thay thế "FlowMotion / FlowMotion LED (high)".

Sách hướng dẫn, thẻ quy cách máy hút bụi và nhãn năng lượng có thể tải về từ trang web của chúng tôi, [www.electrolux.com](http://www.electrolux.com).

Các tính toán đều dựa trên Quy định của Ủy ban Châu Âu số 665/2013 ban hành ngày 03/05/2013 nhằm bổ sung cho Chỉ thị 2010/30/EU. Toàn bộ các quy trình không được mô tả chi tiết hơn trong hướng dẫn này đều dựa trên tiêu chuẩn EN 60312-1:2013.



**中国**

伊莱克斯 (中国) 电器有限公司 上海小家电分公司  
中国, 上海, 静安区共和新路1968号大宁国际广场  
8号楼606室  
办公电话: +86 21 3178 1000  
传真: +86 21 3387 0368  
售后服务: +86 9501 5801  
服务邮箱: saservice.china@electrolux.com  
网站: www.electrolux.com.cn

**台灣**

新加坡商伊萊克斯股份有限公司 台灣分公司  
22065新北市板橋區縣民大道2段68號9F  
免付費客服專線: 0800-888-259  
傳真: 886-2-8964-5269  
電郵: service@electrolux.com.tw  
網站: www.electrolux.com.tw

**KOREA**

Electrolux Korea limited  
9F, Pine Avenue B,  
100 Euljiro, Jung-gu, Seoul, Korea 04551  
Tel : +(82) 2 6020-2200  
Fax: +(82) 2 6020-2271-3  
Customer Care Services : +(82) 1566-1238  
Email : homecare.krh@electrolux.com  
Website: www.electrolux.co.kr

**INDONESIA**

Electrolux Indonesia  
Electrolux Building  
Jl. Abdul Muis No 34, Petojo Selatan  
Gambir, Jakarta 10160, Indonesia  
Tel: +(62) 21 5081 7300  
Fax: +(62) 21 5081 7399  
Customer Care Services: +(62) 0804 111 999  
Email: customercare@electrolux.co.id  
Website: www.electrolux.co.id  
DEPDAG: I.31.E112.01301.1016

**PHILIPPINES**

Electrolux Philippines Inc.  
10th Floor. W5th Avenue Building  
5th Avenue Corner 32nd Street  
Bonifacio Global City,  
Taguig Philippines 1634  
Tel: +(63) 2 737 4757  
Domestic Toll Free : 1 800 10 845 care 2273  
Customer Care Services: +(63) 2 845 care 2273  
Email: wecare@electrolux.com  
Website: www.electrolux.com.ph

**THAILAND**

Electrolux Thailand Co Ltd  
Electrolux Building  
14th Floor 1910 New Petchburi Road  
Bangkapi, Huay Kwang  
Bangkok 10310  
Thailand  
Tel: +(66) 2 725 9100  
Fax: +(66) 2 725 9299  
Customer Care Services: +(66) 2 725 9000  
Email: customercarethai@electrolux.com  
Website: www.electrolux.co.th

**VIETNAM**

Electrolux Vietnam Ltd  
Floor 9th, A&B Tower  
76 Le Lai Street  
Ben Thanh Ward - District 1  
Ho Chi Minh City  
Vietnam  
Tel: +(84) 8 3910 5465  
Fax: +(84) 8 3910 5470  
Customer Care Services: 1800-58-8899  
Email: vncare@electrolux.com  
Website: www.electrolux.vn

**MALAYSIA**

Electrolux Home Appliances Sdn Bhd  
Lot C6, No. 28, Jalan 15/22,  
Taman Perindustrian Tiong Nam,  
40200 Shah Alam, Selangor  
Malaysia  
Customer Care Hotline: 1300-88-11-22  
Customer Care Services Tel: +(60 3) 5525 0800  
Customer Care Services Fax: +(60 3) 5524 2521  
Email: malaysia.customercare@electrolux.com  
Website: www.electrolux.com.my

**SINGAPORE**

Electrolux SEA Pte Ltd  
1 Fusionopolis Place, Galaxis #07-10 (West Lobby)  
Singapore 138522  
Fax: +(65) 6727 3611  
Customer Care Services: +(65) 6727 3699  
Email: customer-care.sin@electrolux.com  
Website: www.electrolux.com.sg

**HONG KONG PRC**

大昌貿易行有限公司  
電器維修中心  
香港九龍灣啟祥道20號  
大昌行集團大廈5樓  
服務熱線: +(852) 3193 9888  
電子郵件: dthead@ead.dch.com.hk  
網頁: www.electrolux.com.hk

**AUSTRALIA**

Electrolux Home Care & Small Domestic Appliances  
ABN 51 004 762 341  
163 O'Riordan Street, Mascot, NSW 2020, Australia  
Customer Service Phone: 1300 365 305  
Website: www.electrolux.com

**NEW ZEALAND**

Electrolux Home Care & Small Domestic Appliances  
A division of Electrolux (NZ) Limited  
3-5 Niall Burgess Road, Mt Wellington,  
Auckland, New Zealand  
Phone: (09) 573 2220  
Customer Service Phone: 0508 730 730  
Website: www.electrolux.com



## VISIT OUR WEBSITE TO:



Get usage advice, brochures, trouble shooter, service information: [www.electrolux.com](http://www.electrolux.com)



Register your product for better service: [www.electrolux.com/productregistration](http://www.electrolux.com/productregistration)



Buy Consumables & Accessories for your appliance: [www.electrolux.com/shop](http://www.electrolux.com/shop)

## CONSUMABLES & ACCESSORIES

[www.electrolux.com/shop](http://www.electrolux.com/shop)



Silent Parketto  
Ref: ZE115  
Part nr: 9001677922



Turbo Brush  
Ref: ZE119  
Part nr: 9001678003



Delicate Care  
Ref: KIT11  
Part nr: 9001679597



Clean & Tidy  
Ref: KIT12  
Part nr: 9001679605



Animal Care  
Ref: KIT13  
Part nr: 9001679613

- s-bag® Ultra Long Performance  
Ref: E210S  
Part nr: 9001684613
- s-bag® Anti-allergy  
Ref: E206S  
Part nr: 9001684605
- s-bag® Anti-odour  
Ref: E203S  
Part nr: 9001684597
- s-bag® Classic Long Performance  
Ref: E201S  
Part nr: 9001684589
- 2 Motor filters  
Ref: EF54  
Part nr: 9000843053



PURED9 Starter Kit  
Ref: ESKD9  
Part nr: 9001684795



Crispy Bamboo  
Ref: ESBA  
Part nr: 9001677773

Brown Sugar & Fig  
Ref: ESFI  
Part nr: 9001677781

Tropical Breeze  
Ref: ESCO  
Part nr: 9001677799

Citrus Burst  
Ref: ESMA  
Part nr: 9001677807

Evening Rose  
Ref: ESRO  
Part nr: 9001677765

s-filter®  
HEPA H13 Washable  
Ref: EFH 13WAPAC  
Part nr: 9001680983



## CUSTOMER CARE AND SERVICE

When contacting Service, ensure that you have the following data available:

- Model Number
- PNC number
- Serial number

The information can be found on the rating plate.

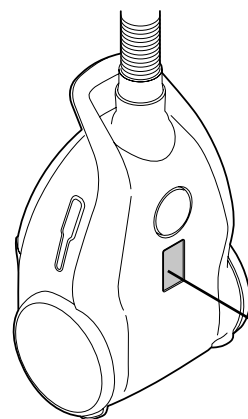

Model Number      PNC Number      Serial Number

			Type <b>HERA</b>
Model code: <b>PD91-4AA</b>	PNC: <b>900 940 600</b>	Etc <b>00</b>	Serial number <b>12345678</b>
		230 V ~ 50 Hz	<b>650W NOM</b>
			Made in EU

[electrolux.com/shop](http://electrolux.com/shop)



Electrolux Appliances AB  
S:t Göransgatan 143  
S-105 45 Stockholm  
Sweden

[www.electrolux.com](http://www.electrolux.com)