



Electrolux

Instruction Book

Ergorapido®
Cordless vacuum cleaner

- ZB3301
- ZB3302AK
- ZB3311
- ZB3314AK
- ZB3320P
- ZB3323B
- ZB3323BO
- ZB3324B
- ZB3324BP
- ZB3325B
- ZB3327G
- ZB3316AK



GB	INSTRUCTION BOOK..... 4	ID	BUKU PETUNJUK..... 13	VI	SÁCH HƯỚNG DẪN..... 22
CS	说明书..... 7	KO	사용설명서..... 16		
CT	說明手冊..... 10	TH	คู่มือการใช้งาน..... 19		

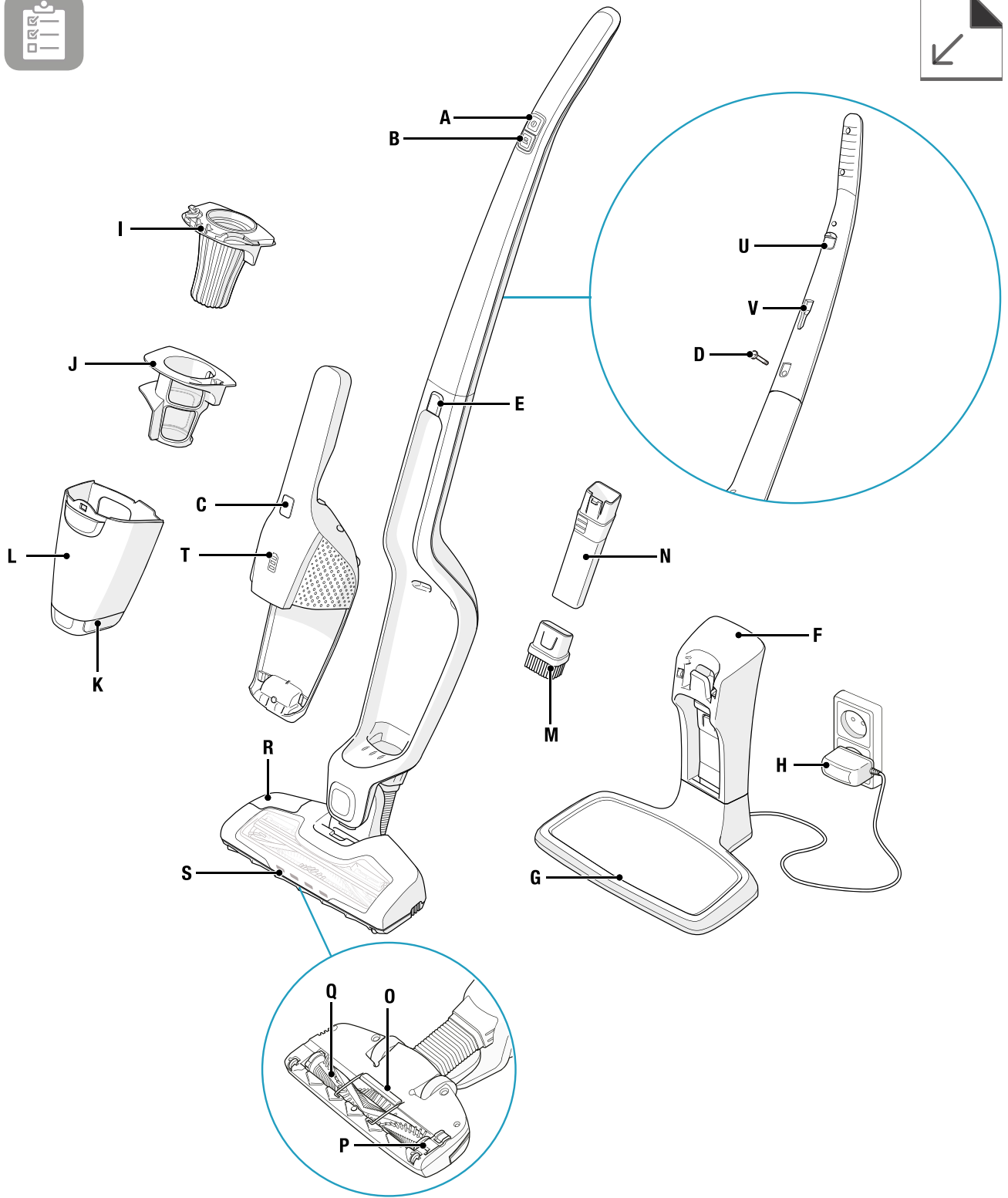

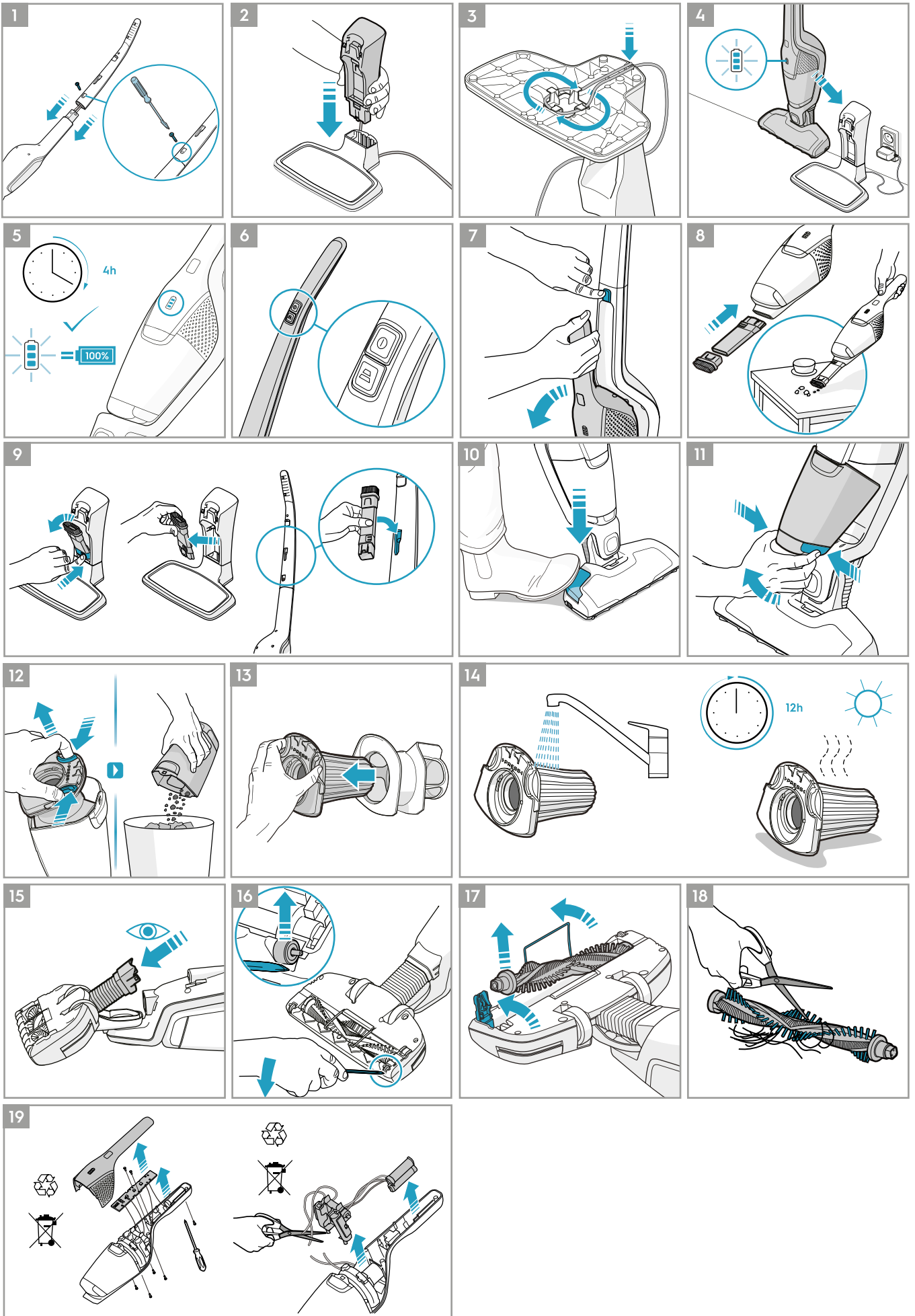

ENGLISH

Thank you for choosing an Electrolux ERGORAPIDO® vacuum cleaner. In order to ensure the best results, always use original Electrolux accessories and spare parts. They have been designed especially for your vacuum cleaner. This product is designed with the environment in mind. All plastic parts are marked for recycling purposes.

DESCRIPTION OF ERGORAPIDO®

- | | |
|-----------------------------------|-------------------------------|
| A. ON/OFF button | M. Dusting brush |
| B. Power regulation button | N. Crevice nozzle |
| C. ON/OFF button, hand unit | O. Cable protector grill |
| D. Locking screw | P. Hatch cover for brush roll |
| E. Release button, hand unit | Q. Brush roll |
| F. Charging station, wall unit | R. BRUSHROLLCLEAN® pedal |
| G. Charging station, floor unit | S. Nozzle front lights |
| H. Charging adapter | T. Charging indicator |
| I. Fine filter (inner filter) | U. Cliff hanger |
| J. Pre filter (outer filter) | V. Slot for accessory storage |
| K. Release button, dust container | |
| L. Dust container | |

BEFORE STARTING

Check that the package includes all parts described in this instruction manual and read this manual carefully. Pay special attention to the safety precautions chapter. Save these instructions.

Picture page 2

- 1 Assemble the handle.
- 2 Assemble the charge stand.
- 3 There is a hollow space in the bottom of the charging station where unused cable can be wound. Insert the adaptor into the mains and position the charging station on a stable and horizontal surface away from heat sources, direct sunlight or wet places.
- 4 The charging indicator will be lit when ERGORAPIDO® is placed in the charging station.

Picture page 3

CHARGING ERGORAPIDO®

- 5 When fully charged, the charging indicator will blink slowly. The numbers of LED lamps will indicate the level of charge. Full charging time is around 4 hours. For better battery performance, charge ERGORAPIDO® for 24 hours before first use and always keep it on charge when not used.

VACUUMING WITH ERGORAPIDO®

Before vacuuming, check that the nozzle wheels and the brush roll are clean from sharp objects in order to avoid scratching sensitive floors and to ensure full cleaning performance.

- 6 Start and stop ERGORAPIDO® by pushing the ON/OFF button. ERGORAPIDO® will start on the high power mode. For more silent cleaning and longer runtime, press the power regulation button.

VACUUMING FURNITURE, CAR SEATS ETC.

- 7 Press the button to release the hand unit from the main body.
- 8 Attach the crevice nozzle to facilitate cleaning of areas difficult to reach. Attach the brush on the crevice nozzle for dusting.
- 9 The crevice nozzle and small brush can be stored in the charging station or in the slot on the back side of the handle.

BRUSHROLLCLEAN® FUNCTION

Use the BRUSHROLLCLEAN® function to keep the brush roll clean and free from hair and fibres. For best results use the BRUSHROLLCLEAN® function when ERGORAPIDO® is fully charged.

- 10 Place ERGORAPIDO® on a hard and flat surface. Do not use the BRUSHROLLCLEAN® function on carpets. Press the BRUSHROLLCLEAN® pedal with your foot while the cleaner is on. Hold for 5 seconds until hairs and fibres are removed. There will be a cutting noise during this process, this is normal. If hairs remain on the brush roll, repeat the process. The BRUSHROLLCLEAN® function is equipped with an overheating protection. If the BRUSHROLLCLEAN® function has been used for more than 30 seconds (constant or interrupted) it will deactivate the brush roll and turn off the nozzle front lights. The vacuum cleaner can still be used, even when the BRUSHROLLCLEAN® function is deactivated. To reactivate the BRUSHROLLCLEAN® function, place ERGORAPIDO® on charge and charge for 15 minutes. Please note that the BRUSHROLLCLEAN® function might not be able to remove thicker threads or wires that are caught in the brush roll.

EMPTYING OF THE DUST CONTAINER

- 11 Remove the dust container by pressing the buttons.
- 12 Take out the filters from the dust container by pressing the release buttons. Empty the contents into a dustbin. Never wash the dust container or filters in a dishwasher.

IMPORTANT - FILTER CLEANING!

- 13 The filters must be cleaned at regular intervals to ensure a high cleaning performance. Take out the filters by pressing the release buttons. Separate the inner filter from the outer filter.
- 14 Rinse the filter parts carefully under lukewarm water without using any detergents. (Never use the dishwasher or washing machine.) Shake to remove excess water and leave to dry minimum 12h before putting them back into the cleaner.

CLEANING THE HOSE AND NOZZLE WHEELS

- 15 Loosen the hose behind the nozzle from its upper connection. Remove any object or debris that can be blocking the airflow in the hose or in the air channel to the dust cup, and put the hose back.
- 16 If the wheels need to be cleaned or get jammed, remove them carefully by using a flat screwdriver.

REMOVING AND CLEANING THE BRUSH ROLL

- 17 If the brushroll gets blocked ERGORAPIDO® will stop. Open the cable protector grill and the brush roll hatch cover and remove the brush roll.
- 18 Use a pair of scissors to remove threads etc. Reassemble the brush roll, making sure it can spin freely.

REMOVING THE BATTERIES FOR RECYCLING

Warning; Battery removal must only be done by an Electrolux service center or official collection point!

- 19 Only remove batteries if the product is to be scrapped. Improper handling of the batteries may be hazardous. **Batteries should always be completely discharged before removal.** Take your product to an Electrolux service center or official collection point for recycling. They can remove and recycle the battery and electric parts in a safe and professional way. Follow your country's rules for collection of rechargeable batteries and electrical products.

Enjoy a great cleaning experience with ERGORAPIDO®!

Electrolux reserves the right to change products, information and specifications without notice.

SAFETY PRECAUTIONS

This appliance is not intended for use by persons (including children) with reduced physical, sensory or mental capabilities, or lack of experience and knowledge, unless they have been given supervision or instruction concerning use of the appliance by a person responsible for their safety.

Children should be supervised to ensure that they do not play with the appliance.

Batteries must be removed from the appliance before it is scrapped.

The battery is to be disposed of safely.

Only use the charging adapter that was provided with the product.

ERGORAPIDO® should only be used for normal vacuuming indoors and in a domestic environment. Make sure it is stored in a dry place. Packaging material, e.g. plastic bags should not be accessible to children to avoid suffocation.

Never use the vacuum cleaner:

- In wet areas.
- Close to flammable gases, etc.
- When the product shows visible signs of damage.
- On sharp objects or liquids.
- On hot or cold cinders, lighted cigarette butts, etc.
- On fine dust, for instance from plaster, concrete, flour, hot or cold ashes.

Caution:

- Do not leave the vacuum cleaner in direct sunlight.
- Avoid exposing the vacuum cleaner to strong heat.
- The battery cells within must not be dismantled, short circuited or placed against a metal surface.
- Never use the vacuum cleaner without its filters.
- Do not try to touch the brush roll while the cleaner is switched on and the brush roll is turning.
- Mind your fingers if cleaning the inside of the floor nozzle. The metal blade of the BRUSHROLLCLEAN® function is sharp and could cause injury.

Using the vacuum cleaner in the above circumstances may cause serious personal injury or damage to the product. Such injury or damage is not covered by the warranty or by Electrolux.

SERVICING AND WARRANTY

All service or repairs must be carried out by an authorized Electrolux service centre.

This warranty does not cover reduction in battery runtime due to battery age or use, as the life of the battery depends upon the amount and nature of use.









To protect the motor, battery and electronics the product should not be stored or operated in:

- An ambient temperature below 5 °C or exceeding 35 °C. If the product is stored in a temperature below 5 °C or exceeding 35 °C, let the product cool down or warm up and dry for a few hours before usage.
- A humidity level below 20% or exceeding 80% (non-condensing).

If the product is stored for an extended time period (without usage or continuous charging), we recommend to store the product in normal room temperature with the batteries charged at 50% capacity or more. This will maintain the performance of the product.

Attention! Dew condensation may form inside the product if the unit is moved from a cold to a warm environment or after heating up the storage room. Wait a few hours for the internal components to warm up and dry before usage.

INDICATION LAMPS

CHARGING 	WHAT DOES IT MEAN?	DURING USAGE	WHAT DOES IT MEAN?
	Blink slowly = 100 % fully charged		75 - 100 % capacity
	50 - 95 % charged		50 - 75 % capacity remaining
	0 - 50 % charged		25 - 50 % capacity remaining
			ERGORAPIDO® needs to be recharged.

VISIT OUR WEBSITE TO:



Get usage advice, brochures, trouble shooter, service information: www.electrolux.com



Register your product for better service: www.electrolux.com/productregistration



Buy Accessories and Consumables for your appliance: www.electrolux.com/shop

CUSTOMER CARE AND SERVICE

When contacting the Electrolux service center, ensure that you have following data available:

- Model number,
- PNC number
- Serial number

The information can be found on the rating plate.

Model number

PNC number

Serial number

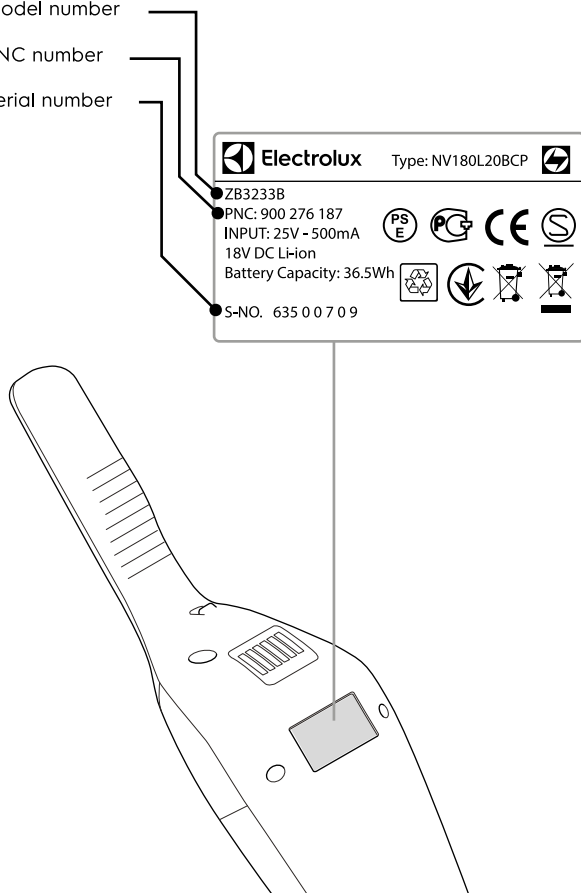

CONSUMABLES & ACCESSORIES



www.electrolux.com/shop

Filter
Ref: EF150
PNC: 900 168 3748



Car Kit
Ref: KIT10A
PNC: 900 167 1677

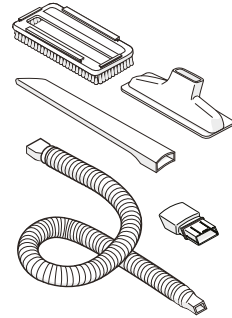

BedPro™ MINI
Ref: ZE125
PNC: 900 168 0819

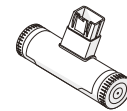

RUNNING TIMES FOR ERGORAPIDO®

Actual running time vary by use and environment

Volt	High power mode	Long runtime mode
14,4V	Approximately 16 minutes	Approximately 42 minutes
18V	Approximately 16 minutes	Approximately 48 minutes

This warranty does not cover reduction in battery runtime due to battery age or use, as the life of the battery depends upon the amount and nature of use.



This symbol on the product indicates that this product contains a built-in rechargeable battery which shall not be disposed with normal household waste.



This symbol on the product or on its packaging indicates that the product may not be treated as household waste.

A

To recycle your product, please take it to an official collection point or to an Electrolux service center that can remove and recycle the battery and electric parts in a safe and professional way. Follow your country's rules for the separate collection of electrical products and rechargeable batteries.

感谢您选择 Electrolux Ergorapido 瑞彼得真空吸尘器。为了保证最佳效果，务必使用原装 Electrolux 配件和备件。它们专门设计用于这款真空吸尘器。本产品设计与环保为本。所有塑料部件均有回收标志。

ERGORAPIDO® 瑞彼得吸尘器使用说明

- | | |
|--------------------|-------------------|
| A. 开关按钮 | M. 除尘刷 |
| B. 强效模式/长效模式档位调节按钮 | N. 缝隙吸嘴 |
| C. 开关按钮，手柄 | O. 电缆保护架 |
| D. 锁紧螺钉 | P. 刷辊舱盖 |
| E. 手持释放按钮 | Q. 刷辊 |
| F. 充电座，靠墙部件 | R. BRC 毛发截断清洁功能踏板 |
| G. 充电座，地板部件 | S. LED 地刷前灯 |
| H. 充电适配器 | T. 充电指示灯 |
| I. 精细过滤网（内部过滤网） | U. 悬挂件 |
| J. 预过滤网（外部过滤网） | V. 配件置物槽 |
| K. 集尘盒释放按钮 | |
| L. 集尘盒 | |

使用前指南

请检查包装内是否包含本说明手册中提到的所有部件，并仔细阅读本手册。应特别注意安全预防措施章节。保存这些说明。

图片页2

- 1 组装机身。
- 2 组装充电座。
- 3 未使用的电缆可卷绕在底部的中空位置内。将适配器插入主机，并将充电座置于稳定的水平表面，远离热源，避免阳光直射，避开潮湿的地方。
- 4 当 Ergorapido 瑞彼得吸尘器放置在充电座上时，充电指示灯会亮起。

图片页3

为 ERGORAPIDO® 瑞彼得吸尘器充电

- 5 当充满电时，充电指示灯会缓慢闪烁。LED 灯数量表示充电量。完全充电时间为约4小时。为了获得更好的电池性能，请在首次使用前对 ERGORAPIDO® 吸尘器充电24小时，并在不使用时始终保持充电状态。

使用 ERGORAPIDO® 吸尘

吸尘之前，请检查地刷滚轮和刷辊是否干净没有尖锐物体，以免刮伤地板并确保最佳清洁效果。

- 6 开关按钮启动按钮或停止机器运行
默认开启模式为强效档位模式按下档位调节按键，将机器从强效模式档位切换为长效清洁模式档位。

为家具、汽车座椅等吸尘。

- 7 按下手持释放按钮，卸下手持部分。
- 8 安装缝隙吸嘴，对于难以触及和清洁的缝隙区域进行清洁。
- 9 缝隙吸嘴和除尘刷可以存放在充电座配件存储区或吸尘器手柄背面配件置物槽中。

BRC 毛发截断清洁功能

BRUSHROLLCLEAN® 功能可以保持刷辊清洁，切断并吸除缠绕在刷辊上的毛发和纤维。

- 10 在硬质的水平表面上使用该产品。请勿在地毯上使用。
BRUSHROLLCLEAN® 毛发截断清洁功能。
吸尘器开启时用脚踩下 BRUSHROLLCLEAN® 踏板保持 5 秒钟，直到毛发和纤维被清除。在此过程中会有切割噪音，这是正常情况。
如刷辊上仍有毛发，请重复该过程。
BRUSHROLLCLEAN® 毛发截断清洁科技具有过热保护功能。如果 BRUSHROLLCLEAN® 功能已使用超过30秒（无论持续还是断续使用），机器将自动停止运作并关闭地刷前灯。要重新启动 BRUSHROLLCLEAN® 功能，请将 ERGORAPIDO® 机器保持充电状态并充电15分钟。
请注意，BRUSHROLLCLEAN® 功能可能无法去除刷辊中缠绕的较粗丝线或电线。

清空集尘盒

- 11 按下集尘盒释放按钮将集尘盒从机器主体分离出来。
- 12 按下释放按钮从集尘盒中取出滤网。清空垃圾，倒入垃圾桶。切勿在洗碗机中清洗集尘盒或过滤网。

重要事项 — 过滤网清洁！

- 13 过滤网必须定期清洁，以确保良好的清洁性能。按释放按钮取出过滤网。将内部滤网与外部滤网分开。
- 14 用温水仔细冲洗过滤网部件，无需使用任何清洁剂。（切勿使用洗碗机或洗衣机）抖去多余的水分，并晾干至少12小时，然后再放回吸尘器。

清洁软管和地刷滚轮

- 15 从地刷后面软管连接口处释放软管，清除软管内异物及碎屑，重新装入软管。
- 16 如果地刷滚轮需要清洁或有异物卡住，请用平口螺丝刀小心将其取出。

拆卸和清洁刷辊

- 17 如果刷辊被阻塞，ERGORAPIDO® 将停止。打开电缆保护架和刷辊舱盖并取下刷辊。
- 18 用剪刀移除线头等。重新组装刷辊，确保转动顺畅。

不要自行取下电池进行回收

- 19 **警告：电池只能由 Electrolux 服务中心专业工作人员进行拆卸。**
如果要丢弃产品，需去指定售后网点拆卸电池。不当处理电池可能会导致危险。电池在取出前应始终完全放电。将您的产品送到 Electrolux 服务中心或官方收集点进行回收。他们能够以安全和专业的方式移除和回收电池及电气部件。请按照您所在国家/地区的规定收集充电电池和电气产品。

ERGORAPIDO® 瑞彼得吸尘器为您带来美好的清洁体验

安全预防措施

本器具不可由肢体伤残、感觉或精神障碍以及缺乏相关经验和知识的人员（包括儿童）使用，除非有负责其安全的人员对其进行看管或指导。

应对儿童加以看管，确保他们不将本产品作为玩具。

在弃置之前，务必从设备上取下电池。

电池应安全处理。

只能使用产品随附的充电适配器。

ERGORAPIDO® 瑞彼得吸尘器只能用于室内和家庭环境中的正常吸尘用途。确保存放在干燥位置。

所有包装材料（如塑料袋）应置于儿童接触不到的地方，以防窒息。

切勿在下列情况使用真空吸尘器：

- 潮湿的地方。
- 接近易燃气体等。
- 产品出现明显的损坏迹象。
- 存在尖锐物体或液体。
- 存在热或冷的灰烬、点燃的烟头等
- 存在细粉尘，例如石膏、水泥、面粉、热或冷的灰烬。

小心：

- 请勿将真空吸尘器置于阳光直射的地方。
- 避免将真空吸尘器暴露在强热环境中。
- 内部电池组不得拆卸、短接或放置在金属表面。
- 切勿使用没有安装滤网的真空吸尘器。
- 在清洁剂打开且刷辊转动时，切勿尝试触摸刷辊。
- 清洁地板吸嘴内部时，请小心手指。BRUSHROLLCLEAN® 毛发截断清洁功能的含金属刀钝刀，请小心清洁。

在上述情况下使用吸尘器可能会导致严重的人身伤害或产品损坏。此类损伤或损坏均不在保修范围内并且不由 Electrolux 承担责任。

服务和保修

所有维护或修理必须由授权的 Electrolux 服务中心提供。

保修不包括由于电池寿命或使用过程而导致的电池运行时间缩短，因为电池寿命取决于使用频率和使用时间。









为了保护电机、电池和电子设备，不应在以下情况中存放或操作本产品：

- 环境温度低于 5°C 或超过 35°C。如果产品在低于 5°C 或高于 35°C 的温度下储存，请在使用前让产品冷却或升温并干燥数小时。
- 湿度水平低于 20% 或超过 80%（无冷凝）。

如果产品长时间存放（不使用或不连续充电），我们建议将产品存放在正常室温下，电池充电量应至少为 50%。这将有助于保持产品性能。

注意！ 如果设备从较冷环境移至温暖环境或制热过的储存室，产品内部可能结露。等待几个小时，以便内部组件在使用前升温 and 干燥。

指示灯

充电 	表示什么含义？	使用期间 	表示什么含义？
	缓慢闪烁 = 100% 充满电		75 - 100 % 容量
	已充电 50 - 95 %		剩余容量 50 - 75%
	已充电 0 - 50%		剩余容量 25 - 50%
			ERGORAPIDO® 需要充电。

请访问我们的网站:



获取使用建议、手册、故障排除、服务信息：
www.electrolux.com

客户服务

在您联系Electrolux服务中心前，请准备好以下数据：

- 型号，
- PNC编号
- 序列号

可以在铭牌上找到相关信息。

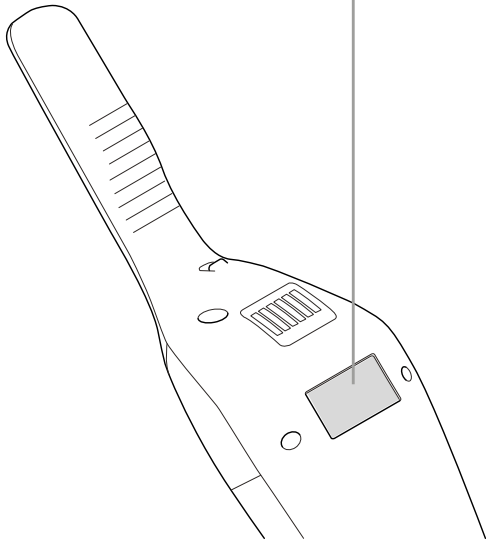
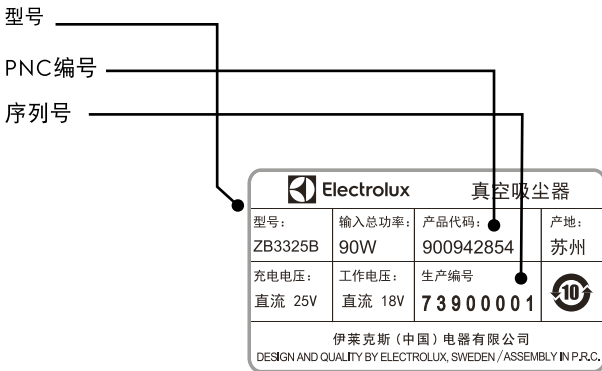

可选耗材与配件

滤网
参照: EF150
PNC: 900 168 3748



车载套件
参照: KIT10A
PNC: 900 167 1677

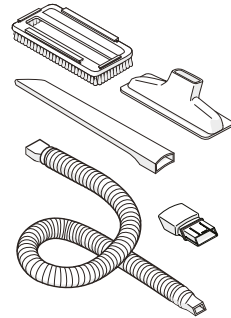

BedPro™ MINI
参照: ZE125
PNC: 900 168 0819

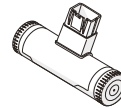

ERGORAPIDO® 使用时间

实际使用时间视不同使用方式和使用环境等其他因素而定。

电压	高动力运作模式	长时间运作模式
14,4V	约 16 分钟	约 42 分钟
18V	约 16 分钟	约 48 分钟

保修不包括由于电池寿命或使用过程而导致的电池运行时间缩短，因为电池寿命取决于使用频率和使用时间。



产品上的此符号表示本产品包含内置的可充电电池，不得与普通生活垃圾一起处理。



产品或包装上的此符号表示该产品不能作为家庭废弃物来弃置。



要回收您的产品，请将其送至官方收集点或Electrolux服务中心，以便以安全和专业的方式移除和回收电池和电气部件。按照您所在国家的规定，单独收集电气产品和可充电电池。

繁體中文

感謝您購買伊萊克斯 ERGORAPIDO® 吸塵器。為確保最佳效果，請使用伊萊克斯原裝配件和備件。它們專為您的吸塵器而設計。本產品以環保概念為設計理念。所有塑膠零件均標有回收標誌。

ERGORAPIDO® 說明

- | | |
|---------------|-----------------------------------|
| A. 開關按鈕 | M. 毛刷吸頭 |
| B. 強力／中段按鈕 | N. 隙縫吸頭 |
| C. 開關按鈕（手持裝置） | O. 滾刷護蓋 |
| D. 固定螺釘 | P. 滾刷鬆開按鈕 |
| E. 鬆開按鈕（手持裝置） | Q. 滾刷 |
| F. 充電座（牆壁裝置） | R. 毛髮截斷科技
（BRUSHROLLCLEAN® 踏板） |
| G. 充電座（地面裝置） | S. 吸頭前置燈 |
| H. 充電變壓器 | T. 充電指示器 |
| I. 精密濾網（內濾網） | U. 邊緣倚靠點 |
| J. 前濾網（外濾網） | V. 配件收納槽 |
| K. 集塵盒鬆開按鈕 | |
| L. 集塵盒 | |

使用前

請檢查包裝內包括此說明手冊描述的所有部件，並仔細閱讀此手冊。請特別注意安全注意事項的章節。請妥善保存這些說明。

第 2 頁圖片

- 1 組裝把手。
- 2 組裝充電座。
- 3 充電座底部有一個空心位置，可用以將沒有使用的電源線纏繞好。將充電變壓器插入總電源，並將充電座放置在遠離熱源、陽光直射或潮濕地方的平穩表面上。
- 4 當 ERGORAPIDO® 放在充電座時，充電指示器會亮起。

第 3 頁圖片

ERGORAPIDO® 充電

- 5 充滿電時，充電指示器會慢慢閃爍。LED 燈數目表示充電量。充滿約需 4 小時。為提升電池效能，第一次使用 ERGORAPIDO® 前請先充電 24 小時，且不使用時務必放在充電座上。

ERGORAPIDO® 吸塵

清掃前，檢查吸頭滾輪和滾刷上是否有尖銳物體，以防刮花敏感脆弱的地面，確保全面清潔效果。

- 6 按下開關按鈕以啟動和停止 ERGORAPIDO®。ERGORAPIDO® 會以強力模式啟動。如需讓運轉時更安靜並延長運轉時間，請按下強力／中段按鈕。

針對家具、汽車座椅等物品吸塵

- 7 按下鬆開按鈕，使手持裝置脫離主機。
- 8 裝上隙縫吸頭，以便清潔難以觸及的地方。在隙縫吸頭上裝上毛刷吸頭以便集塵。
- 9 隙縫吸頭和毛刷吸頭可收納在充電座或把手背面的配件收納槽內。

BRUSHROLLCLEAN® 毛髮截斷功能

BRUSHROLLCLEAN® 功能可讓滾刷保持乾淨，去除毛髮與纖維。為達最佳效果，請在 ERGORAPIDO® 充滿電時使用 BRUSHROLLCLEAN® 功能。

- 10 將 ERGORAPIDO® 放在堅硬平坦的表面上。請勿在地毯上使用 BRUSHROLLCLEAN® 功能。
當吸塵器啟動時，用您的腳按下 BRUSHROLLCLEAN® 踏板。維持 5 秒直到清除毛髮和纖維。過程中會有切割的噪音，這是正常情形。如毛髮仍然在滾刷上，請重覆過程。
BRUSHROLLCLEAN® 功能具備過熱保護機制。如果使用 BRUSHROLLCLEAN® 功能超過 30 秒（連續或間歇），將停用滾刷並關閉吸頭前置燈。BRUSHROLLCLEAN® 功能停用後，真空吸塵器仍可繼續使用。若要重新啟動 BRUSHROLLCLEAN® 功能，請將 ERGORAPIDO® 放到充電座上並充電 15 分鐘。
請注意，BRUSHROLLCLEAN® 功能可能無法去除卡在滾刷中的較粗線頭或電線。

清空集塵盒

- 11 按下鬆開按鈕，取出集塵盒。
- 12 按下鬆開按鈕，將濾網從集塵盒內取出。清除其中的灰塵並倒入垃圾箱。請勿用洗碗機沖洗集塵盒或濾網。

重要 - 清潔濾網！

- 13 必須定期清潔濾網，以確保能有良好清潔效能。按下鬆開按鈕取出濾網。將內濾網與外濾網分開。
- 14 小心用溫水沖洗過濾部分，不要用任何清潔劑。（切勿使用洗碗機或洗衣機。）搖動以去掉多餘水分，然後自然風乾最少 12 小時，再裝回吸塵器內。使用前必須先確認濾網已經完全風乾。

清潔軟管和吸嘴滾輪

- 15 由上端連接鬆開吸頭後的軟管。將軟管和空氣管道內任何可能阻擋空氣流通的物體或碎屑清除到塵粒容器，然後將軟管放回原處。
- 16 如滾輪需要清潔或被卡住，小心用平頭螺絲起子移除它們。

取出滾刷及清潔滾刷

- 17 如果滾刷阻塞，ERGORAPIDO® 將停止運作。打開滾刷護蓋和滾刷鬆開按鈕，然後取出滾刷。
- 18 用剪刀清除線頭等阻塞物。重新安裝滾刷，確保它能自由轉動。

取出電池並回收處理

- 19 警告；電池僅能由伊萊克斯客戶服務中心或官方回收站點取出！只有在棄置本機前需要將電池取出。未正確處理電池可能導致危險。在取出電池前必須先完全放電。請將產品帶到伊萊克斯客戶服務中心或官方回收站點以進行回收。人員將以安全且專業的方式取出電池和電子零件並進行回收。請遵循您所在國家的規範，來回收可充電電池和電子產品。

請享受 ERGORAPIDO® 帶來的絕佳清潔體驗！

伊萊克斯保留隨時變更產品、資訊與規格之權利，恕不事先通知。

安全注意事項

本機設計不適合體格、感官或精神能力不健全，或者是缺少經驗和知識的人士（包括兒童）使用，除非他們已透過負責他們安全的人士獲得有關使用本機的監督或說明。

請監督兒童確保他們不會把玩本機。

棄置本機前必須先將電池取出。

電池應以安全的方式棄置。

只能使用本機隨附的充電變壓器。

ERGORAPIDO® 只適用於室內及居家環境的一般清掃。請務必將本機存放於乾燥的地方。
包裝物料（例如塑膠袋）皆不應放置在兒童可接觸到的地方，以免導致窒息。

請勿將吸塵器用於：

- 潮濕的地方。
- 在易燃氣體等附近。
- 產品出現明顯損壞跡象時。
- 在尖銳的物品或液體上。
- 在熱或冷的灰燼、點燃的菸頭等。
- 在石膏、混凝土、麵粉、熱或冷灰燼等微細粉塵上。

注意：

- 請勿讓吸塵器受到日光直射。
- 請避免吸塵器承受高熱。
- 本機內部的電池組不得拆卸、使其短路或放置於金屬表面。
- 請勿在未安裝濾網下使用吸塵器。
- 若吸塵器已啟動且滾刷正在轉動，請勿嘗試觸碰滾刷。
- 清潔地板吸頭內部時請小心手指。BRUSHROLLCLEAN® 功能的金屬刀片很鋒利，可能導致受傷。

於上述情況下使用吸塵器可能導致嚴重人身傷害或產品損壞。本機的保固或伊萊克斯公司對此等傷害或損壞不予負責。

維修與保固

所有的服務或維修皆必須由伊萊克斯客戶服務中心執行。

由於電池壽命和使用方式而導致電池運作時間縮短的情形不屬於保固範圍，因為電池的使用壽命取決於使用的次數和方式。









為保護馬達、電池與電子零件，請勿在下列環境下存放或操作：

- 低於 5°C 或高於 35°C 的室溫。如果產品存放在低於 5°C 或高於 35°C 的室溫下，使用前請先讓產品降溫或升溫並風乾數小時。
- 20% 以下或 80% 以上的濕度（非冷凝）。

如需長時間存放產品（不使用或不持續充電），建議將電池電量充滿 50% 或以上，並將產品存放在正常室溫下，以維持產品的效能。

注意！如果將本機從低溫環境移動到高溫環境，或在儲藏室內開啟暖氣，產品內可能會產生凝露。使用前請先稍候數小時，讓內部組件回暖乾燥。

指示燈

充電中 	燈號代表意義	使用中	燈號代表意義
	緩慢閃爍 = 100 % 充滿電		75 - 100 % 電量
	已充電 50 - 95 %		50- 75 % 剩餘電量
	已充電 0 - 50 %		25 - 50 % 剩餘電量
			ERGORAPIDO® 需充電。

請造訪我們的網站，以便：



取得產品使用建議、手冊、疑難排以及服務資訊：
www.electrolux.com.tw



註冊產品享受更佳服務：
electrolux.com.tw/Support/Warranty-Registration/



購買產品零配件及耗材：
客服專線：0800-888-259

客戶保養及檢修服務

聯絡伊萊克斯客戶服務中心時，請備妥下列資料：

- 型號
- PNC 編號
- 機號

上述資訊可在標籤上查找。

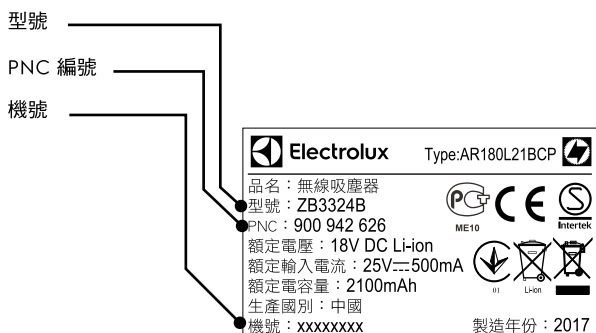

耗材與配件



客服專線：0800-888-259

濾網
參考編號：EF150
PNC: 900 168 3748



汽車套件
參考編號：KIT10A
PNC: 900 167 1677

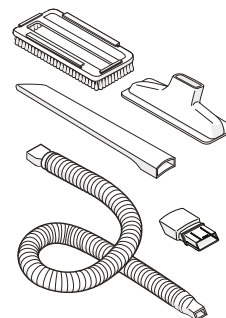

BedPro™ MINI
參考編號：ZE125
PNC: 900 168 0819

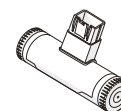

※配件組合會依據各國家販售型號而有所不同，
請洽詢各國家之客服專線或官網資訊。

ERGORAPIDO® 運轉時間

實際使用時間視不同使用方式、使用環境等其他因素而定。

電壓	高動力模式	長運作時間模式
14,4V	約 16 分鐘	約 42 分鐘
18V	約 16 分鐘	約 48 分鐘

由於電池壽命和使用方式而導致電池運作時間縮短的情形不屬於保固範圍，因為電池的使用壽命取決於使用的次數和方式。



產品上的這個標記表示產品包含內建的可充電電池，而電池不應隨一般家庭垃圾棄置。



產品或其包裝上的這個標記表示不能將產品視為家庭垃圾進行處理。

若要回收產品，請將其送到正式回收站點或伊萊克斯客戶服務中心，這些地方能夠以安全、專業的方式來移除和回收電池與電器零件。請遵循您所在國家的規範，分別回收電器產品和可充電電池。

BAHASA INDONESIA

Terima kasih telah memilih pengisap debu Electrolux ERGORAPIDO®. Guna memastikan hasil terbaik, selalu gunakan aksesoris dan suku cadang asli Electrolux. Aksesoris dan suku cadang asli didesain khusus untuk pengisap debu Anda. Produk ini dirancang dengan mempertimbangkan lingkungan hidup. Semua komponen plastik ditandai untuk tujuan daur ulang.

DESKRIPSI ERGORAPIDO®

- | | |
|---------------------------------------|--|
| A. Tombol ON/OFF | M. Sikat debu |
| B. Tombol pengatur daya | N. Nozel pipih |
| C. Tombol ON/OFF, unit tangan | O. Pemanas pelindung kabel |
| D. Sekrup pengunci | P. Penutup tempat rol sikat |
| E. Tombol pelepas, unit tangan | Q. Rol sikat |
| F. Stasiun pengisi daya, unit dinding | R. Pedal® BRUSHROLLCLEAN |
| G. Stasiun pengisi daya, unit lantai | S. Lampu depan nozel |
| H. Adaptor pengisi daya | T. Indikator pengisi daya |
| I. Filter halus (filter dalam) | U. Penggantungan dinding |
| J. Pra-filter (filter luar) | V. Sbanyak untuk penyimpanan aksesoris |
| K. Tombol pelepas, penampung debu | |
| L. Wadah debu | |

SEBELUM MEMULAI

Periksa bahwa kemasan mencakup semua komponen sebagaimana dijelaskan dalam buku panduan ini dan bacalah panduan ini dengan saksama. Perhatikan baik-baik bab langkah pencegahan untuk keselamatan. Simpan petunjuk ini.

Halaman gambar 2

- 1 Pasang pegangan.
- 2 Pasang tongkat pengisi daya
- 3 Di tongkat tersebut ada ruang berlubang pada bagian alas stasiun pengisian daya, di mana kabel yang tidak dipakai dapat rusak. Masukkan adaptor ke dalam jala-jala listrik dan posisikan tempat pengisian daya pada permukaan horizontal yang stabil jauh dari sumber panas, sinar matahari langsung, atau tempat basah.
- 4 Indikator pengisian daya akan menyala ketika ERGORAPIDO® ditempatkan pada tempat pengisian daya. Masukkan adaptor ke sumber listrik dan letakkan stasiun pengisi daya pada permukaan yang stabil dan mendatar, jauh dari sumber panas, sinar matahari langsung, atau tempat basah.

Halaman gambar 3

MENGISI DAYA ERGORAPIDO®

- 5 Saat diisi daya secara penuh, indikator pengisi daya akan berkedip secara perlahan. Jumlah lampu LED akan menunjukkan tingkat pengisian daya. Waktu pengisian daya penuh adalah sekitar 4 jam. Untuk kinerja baterai yang lebih baik, isi daya ERGORAPIDO® selama 24 jam sebelum kali pertama digunakan dan selalu simpan dalam keadaan berdaya saat tidak digunakan.

MEMBERSIHKAN DENGAN ERGORAPIDO®

Sebelum mengisap debu, pastikan bahwa roda nozel dan rol sikat bebas dari benda tajam untuk menghindari goresan pada lantai yang sensitif dan untuk memastikan kinerja pembersihan penuh.

- 6 Nyalakan dan matikan ERGORAPIDO® dengan menekan tombol NYALA/MATI. ERGORAPIDO® akan hidup dengan mode daya tinggi. Untuk pembersihan yang tenang dan waktu operasi yang lebih lama, tekan tombol pengaturan daya.

MEMBERSIHKAN MEBEL, JOK MOBIL DLL.

- 7 Tekan tombol untuk melepaskan unit pegangan dari alat utama.
- 8 Pasang nozel celah untuk mempermudah pembersihan area yang sulit dijangkau. Pasang sikat pada nozel celah untuk mengisap debu.
- 9 Nozel celah dan sikat kecil dapat disimpan di stasiun pengisi daya atau di slot pada bagian belakang pegangan.

FUNGSI BRUSHROLLCLEAN®

Gunakan fungsi BRUSHROLLCLEAN® untuk menjaga rol sikat tetap bersih dan bebas dari rambut dan berbagai serat. Untuk hasil terbaik

gunakan fungsi BRUSHROLLCLEAN® saat ERGORAPIDO® terisi daya dengan penuh.

- 10 Letakkan ERGORAPIDO® pada permukaan yang keras dan datar. Jangan gunakan fungsi BRUSHROLLCLEAN® pada karpet. Tekan pedal BRUSHROLLCLEAN® dengan kaki Anda saat alat pembersih menyala. Tahan selama 5 detik sampai rambut dan serat terisap bersih dan kemudian lepaskan pedal. Selama proses ini akan muncul suara pemotongan, hal ini normal. Jika rambut masih tersangkut pada rol sikat, ulangi lagi proses ini. Fungsi BRUSHROLLCLEAN® dilengkapi dengan sebuah pelindung panas berlebih. Jika fungsi BRUSHROLLCLEAN® telah digunakan selama lebih dari 30 detik (terus-menerus atau berjeda), fungsi tersebut akan menonaktifkan rol sikat dan mematikan lampu depan nozel. Pengisap debu masih dapat digunakan, meski saat fungsi BRUSHROLLCLEAN® dinonaktifkan. Untuk mengaktifkan ulang fungsi BRUSHROLLCLEAN®, letakkan ERGORAPIDO® pada pengisi daya dan isi daya selama 15 menit. Harap catat bahwa fungsi BRUSHROLLCLEAN® mungkin tidak dapat membersihkan benang-benang atau kawat-kawat tebal yang tersangkut di rol sikat.

MENGOSONGKAN WADAH DEBU.

- 11 Lepas wadah debu dengan menekan tombol.
- 12 Keluarkan filter dari wadah debu dengan menekan tombol lepas. Kosongkan isinya ke dalam tempat pembuangan debu. Jangan sekali-kali mencuci penampung debu atau filter dalam mesin pencuci piring.

PENTING - PEMBERSIHAN FILTER!

- 13 Filter harus dibersihkan pada interval yang teratur untuk memastikan kinerja pembersihan yang tinggi. Keluarkan filter dengan menekan tombol pelepas. Pisahkan filter dalam dari filter luar.
- 14 Cuci komponen filter dengan hati-hati di bawah guyruran air hangat tanpa menggunakan deterjen. (Jangan menggunakan mesin pencuci piring atau mesin pencuci baju.) Goyang untuk mengeluarkan air yang tersisa dan biarkan kering minimum selama 12 jam sebelum memasukkannya kembali ke alat pembersih.

MEMBERSIHKAN SELANG DAN RODA NOSEL

- 15 Kendurkan slang di belakang nozel dari sambungan atasnya. Buang semua benda atau kotoran yang dapat memblokir aliran udara di dalam slang atau di dalam saluran udara ke mangkuk debu, dan pasang slang kembali.
- 16 Jika roda harus dibersihkan atau mengalami kemacetan, lepaskan roda secara hati-hati dengan menggunakan sebuah obeng datar.

MELEPAS DAN MEMBERSIHKAN ROL SIKAT

- 17 Jika rol sikat tersumbat, ERGORAPIDO® akan berhenti bekerja. Buka pemanas pelindung kabel dan tutup palka rol sikat, kemudian lepaskan rol sikat.
- 18 Gunakan gunting untuk membuang benang, dll. Rakit kembali rol sikat, sambil memastikan bahwa rol bisa berputar dengan bebas.

MELEPAS BATERAI UNTUK PENDAURAN ULANG

Peringatan; Pelepasan baterai hanya dilakukan oleh pusat layanan Electrolux atau tempat koleksi resmi!

- 19 Hanya lepas baterai jika produk akan dibuang. Penanganan baterai yang tidak dapat berbahaya. **Baterai harus tidak memiliki daya sama sekali sebelum dibuang.** Bawa produk Anda ke pusat layanan Electrolux atau tempat koleksi resmi untuk pendauran ulang. Para petugas Electrolux dapat melepas dan mendaur ulang baterai dan komponen listrik dengan cara yang aman dan profesional. Ikuti peraturan negara Anda untuk pengumpulan baterai yang dapat diisi daya ulang dan produk-produk listrik.

Nikmati pengalaman pembersihan yang luar biasa dengan ERGORAPIDO®!

Electrolux berhak untuk mengubah produk, informasi, dan spesifikasinya tanpa pemberitahuan.

TINDAKAN KEAMANAN

Alat ini tidak ditujukan untuk digunakan oleh orang (termasuk anak-anak) dengan keterbatasan fisik, indera, atau kemampuan mental, atau kurang pengalaman dan pengetahuan, kecuali jika mereka diawasi atau diberi petunjuk mengenai penggunaan alat tersebut oleh orang yang bertanggung jawab atas keselamatan mereka.

Anak-anak harus diawasi untuk memastikan bahwa mereka tidak bermain dengan alat tersebut.

Baterai harus dilepas dari alat sebelum dibuang.

Baterai harus dibuang dengan aman.

Hanya gunakan adaptor pengisi daya yang telah disertakan dengan produk.

ERGORAPIDO® harus hanya digunakan untuk pengisapan debu di dalam ruangan secara normal dan di lingkungan rumah tangga. Pastikan alat disimpan di tempat yang kering.

Bahan kemasan, misalnya kantung plastik harus dijauhkan dari jangkauan anak-anak agar tidak tertelan.

Jangan pernah gunakan pengisap debu:

- Di tempat basah.
- Dekat dekat gas yang mudah terbakar, dll.
- Saat produk menunjukkan tanda-tanda berbahaya dengan jelas.
- Pada benda tajam atau aneka cairan.
- Pada abu yang panas atau dingin, puntung rokok yang menyala, dll.
- Pada debu halus, misalnya dari plester, beton, tepung, serta abu panas atau dingin.

Perhatian:

- Jangan letakkan pengisap debu di bawah sinar matahari langsung.
- Hindari mendekatkan pengisap debu ke panas yang tinggi.
- Dilarang membongkar sel baterai, menghubungkannya dengan sirkuit pendek, atau menempatkannya pada permukaan logam.
- Jangan pernah gunakan pengisap debu tanpa filternya.
- Jangan coba untuk menyentuh rol sikat saat pembersih menyala dan rol sikat sedang berputar.
- Atur jari-jari Anda saat membersihkan bagian dalam nosel lantai. Pisau logam fungsi BRUSHROLLCLEAN® tajam dan dapat menyebabkan cedera.









Menggunakan pengisap debu di lingkungan di atas dapat menyebabkan cedera serius atau kerusakan pada alat. Cedera atau kerusakan tersebut tidak dilindungi oleh garansi atau oleh Electrolux.

SERVIS DAN GARANSI

Semua layanan atau perbaikan harus dilakukan oleh pusat servis resmi Electrolux.

Garansi ini tidak menanggung pengurangan waktu operasi baterai karena usia atau penggunaan baterai, sebab masa pakai baterai tergantung pada jumlah dan sifat penggunaan.

LAMPU INDIKASI

PENGISIAN DAYA 	APA ARTINYA?	SELAMA PENGGUNAAN	APA ARTINYA?
	Berkedip perlahan = 100 % daya terisi penuh		Kapasitas 75 - 100 %
	50 - 95 % daya terisi		50 - 75 % daya tersisa
	0 - 50 % daya terisi		25 - 50 % daya tersisa
			ERGORAPIDO® perlu diisi ulang.

Untuk melindungi motor, baterai dan aneka komponen elektronik, produk harus disimpan atau dioperasikan di:

- Suhu sekitar di bawah 5 °C atau di atas 35 °C. Jika produk disimpan di suhu di bawah 5 °C atau di bawah 35 °C, biarkan produk dingin atau panas dan kering selama beberapa jam sebelum penggunaan.
- Tingkat kelembapan di bawah 20% atau di atas 80% (nonkondensasi).

Jika produk disimpan untuk periode waktu yang diperpanjang (tanpa penggunaan atau pengisian daya terus-menerus), kami menyarankan untuk menyimpan produk di suhu ruangan normal dengan baterai yang diisi dengan kapasitas 50% atau lebih. Tindakan ini akan menjaga kinerja produk tersebut.

Perhatian! Kondensasi embun dapat muncul di dalam produk jika unit dipindahkan dari lingkungan dingin ke hangat atau setelah pemanasan ruang penyimpanan. Tunggu selama beberapa jam agar komponen internal memanas dan mengering sebelum penggunaan.

KUNJUNGI SITUS WEB KAMI UNTUK:



Dapatkan saran pemakaian, brosur, pemecahan masalah, dan informasi layanan: www.electrolux.com



Daftarkan produk Anda untuk layanan yang lebih baik: www.electrolux.com/productregistration



Beli Aksesori dan Barang Pakai untuk peralatan Anda: www.electrolux.com/shop

PERAWATAN DAN LAYANAN PELANGGAN

Saat menghubungi pusat layanan Electrolux, pastikan Anda memiliki data berikut yang tersedia:

- Nomor model,
- Nomor PNC
- Nomor seri

Informasi tersebut dapat dilihat pada pelat nilai.

Nomor model

Nomor PNC

Nomor seri

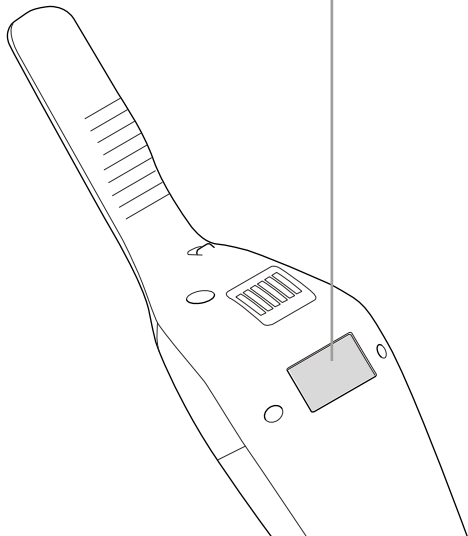
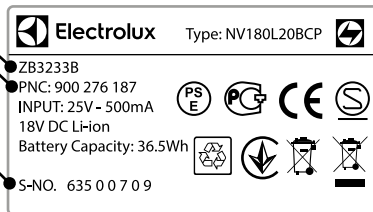

BARANG SEHARI-HARI & AKSESORIS



www.electrolux.com/shop

Filter
Ref: EF150
PNC: 900 168 3748



Kit Mobil
Ref: KIT10A
PNC: 900 167 1677

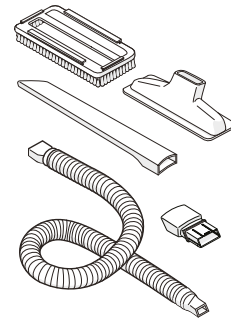

BedPro™ MINI
Ref: ZE125
PNC: 900 168 0819

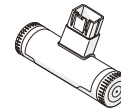

WAKTU OPERASI UNTUK ERGORAPIDO®

Durasi waktu yang dibutuhkan tergantung dari pemakaian dan lingkungan

Volt	Mode tegangan tinggi	Mode waktu operasi panjang
14,4V	16 mnt kurang lebih	42 mnt kurang lebih
18V	16 mnt kurang lebih	48 mnt kurang lebih

Garansi ini tidak menanggung pengurangan waktu operasi baterai karena usia atau penggunaan baterai, sebab masa pakai baterai tergantung pada jumlah dan sifat penggunaan.



Simbol pada produk ini menunjukkan bahwa produk ini terpasang baterai yang dapat diisi ulang yang tidak boleh dibuang sembarangan dengan limbah rumah tangga biasa.



Simbol pada produk atau kemasan tersebut menunjukkan bahwa produk tersebut tidak boleh diperlakukan seperti limbah rumah tangga.

Untuk mendaur ulang produk Anda, bawa produk ke tempat koleksi resmi atau ke pusat layanan Electrolux yang dapat melepas dan mendaur ulang baterai serta aneka komponen listrik dengan cara yang aman dan profesional. Patuhi peraturan negara Anda untuk pengumpulan aneka produk listrik yang terpisah serta baterai yang dapat diisi ulang.

한국어

Electrolux ERGORAPIDO® 진공 청소기를 선택해 주셔서 감사합니다. 최상의 결과를 보장하기 위해서, 본 청소기를 위해 특별히 설계된 Electrolux 정품 액세서리 및 부품을 사용하십시오. 이 제품은 환경을 감안해 설계되었습니다. 모든 플라스틱 부품에는 재활용을 위한 표시가 되어 있습니다.

ERGORAPIDO® 설명

- | | |
|---------------------|-----------------------|
| A. ON/OFF 버튼 | M. 먼지 청소용 브러쉬 |
| B. 파워 조절 버튼 | N. 틈새 노즐 |
| C. ON/OFF 버튼, 핸드 유닛 | O. 케이블 보호 그릴 |
| D. 잠금 나사 | P. 브러쉬 롤용 해치 커버 |
| E. 분리 버튼, 핸드 유닛 | Q. 브러쉬 롤 |
| F. 충전 스탠드, 상단부 | R. BRUSHROLLCLEAN® 페달 |
| G. 충전 스탠드, 하단부 | S. 노즐 전면 라이트 |
| H. 충전 어댑터 | T. 충전 표시등 |
| I. 이너 필터(내부 필터) | U. 파킹 스트립 |
| J. 프리 필터(외부 필터) | V. 액세서리 보관용 슬롯 |
| K. 분리 버튼, 먼지통 | |
| L. 먼지통 | |

시작하기 전에

이 사용 설명서에 기술된 대로 패키지에 모든 부속품이 포함되어 있는지 확인하고 이 설명서를 꼼꼼히 읽으십시오. 안전 주의 사항 장에 특별한 주의를 기울이십시오. 이 설명서를 잘 보관하십시오.

2페이지 그림

- 1 손잡이를 조립합니다.
- 2 충전 스탠드를 조립합니다.
- 3 충전 스탠드의 아래쪽에 있는 빈 공간에 사용하지 않는 케이블을 감아둘 수 있습니다. 전원에 어댑터를 삽입하고 열원, 직사광선이나 젖은 곳에서 멀리 떨어져 있고, 안정적이고 평평한 곳에 충전 스탠드를 배치하십시오.
- 4 ERGORAPIDO®를 충전 스탠드에 올려놓으면 충전 표시등이 켜집니다.

3페이지 그림

ERGORAPIDO® 충전

- 5 완전히 충전되면, 충전 표시등이 천천히 깜박입니다. LED 램프의 수는 충전의 수준을 나타냅니다. 완전 충전 소요 시간은 약 4시간입니다. 처음 사용하기 전에 ERGORAPIDO®를 24시간 충전하고 사용하지 않을 경우에도 항상 충전하여 주십시오.

ERGORAPIDO®를 사용한 청소

민감한 바닥이 긁히는 일을 막고 완벽한 청소 성능을 보장하기 위해 청소 전에 노즐 휠과 브러쉬 롤에 날카로운 물체가 끼어 있지 않은지 확인하십시오.

- 6 ON/OFF 버튼을 눌러 ERGORAPIDO®를 시작 및 중지시키십시오. ERGORAPIDO®는 파워 모드로 시작됩니다. 더 조용하게 오랜 시간 청소하려면 전원 조절 버튼을 누르십시오.

가구나 차량 시트 등의 청소

- 7 버튼을 눌러 본체에서 핸드 유닛을 분리합니다.
- 8 닿기 힘든 곳의 청소를 쉽게 해 주는 틈새 노즐을 부착합니다. 먼지 제거를 위해 틈새 노즐에 브러쉬를 부착합니다.
- 9 틈새 노즐 및 소형 브러쉬는 충전 스탠드나 손잡이 뒷면 슬롯에 보관할 수 있습니다.

BRUSHROLLCLEAN® 기능

브러쉬 롤에서 털과 섬유를 제거하려면 BRUSHROLLCLEAN® 기능을 이용하십시오. 최선의 결과를 얻으려면 ERGORAPIDO®가 완전히 충전된 후 BRUSHROLLCLEAN® 기능을 사용하십시오.

- 10 ERGORAPIDO®를 단단하고 평평한 표면에 놓습니다. 카펫에서 BRUSHROLLCLEAN® 기능을 사용하지 마십시오. 청소기를 켜 상태로 발로 BRUSHROLLCLEAN® 페달을 누르십시오. 털과 섬유가 제거될 때까지 5초 동안 누르십시오. 이 과정에서 커팅되는 소음이 있을 것입니다. 이것은 정상입니다. 털이 브러쉬 롤에 남아있는 경우 프로세스를 반복합니다. BRUSHROLLCLEAN® 기능에는 과열 방지 기능이 탑재되어 있습니다. BRUSHROLLCLEAN® 기능을 30초(계속 또는 간헐적) 이상 사용하면 브러쉬 롤의 작동이 멈추고 노즐 전면 라이트가 꺼집니다. BRUSHROLLCLEAN® 기능이 비활성화되더라도 진공 청소기는 계속 사용할 수 있습니다.

BRUSHROLLCLEAN® 기능이 브러쉬 롤에 끼어 있는 두꺼운 실이나 와이어를 제거하지 못할 수도 있습니다.

먼지통 비우기

- 11 버튼을 눌러 먼지통을 분리하십시오.
- 12 분리 버튼을 눌러 먼지통에서 필터를 꺼내십시오. 쓰레기통에 내용물을 비웁니다. 식기 세척기에 먼지통 또는 필터를 세척하지 마십시오.

중요- 필터 세척!

- 13 필터는 높은 청소 성능을 보장하기 위해 일정한 간격으로 세척해야 합니다. 분리 버튼을 눌러 필터를 꺼내십시오. 외부 필터에서 내부 필터를 분리하십시오.
- 14 세제를 사용하지 않고 미지근한 물에서 조심스럽게 필터 부분을 씻습니다. (절대 식기 세척기나 세탁기를 사용하지 마십시오.) 청소기에 다시 넣기 전에 흔들어서 물기 제거하고 최소 12시간 이상 건조시키십시오.

호스 및 노즐 휠 청소

- 15 위쪽 연결 부위에서 노즐 뒤의 호스를 분리합니다. 호스 또는 먼지통으로 향하는 공기 흐름을 막는 이물질 제거하십시오. 그리고 호스를 다시 연결합니다.
- 16 바퀴에 이물질이 끼었거나 청소해야 할 경우, 일자 드라이버를 사용하여 조심스럽게 제거하십시오.

브러쉬 롤 분리 및 청소

- 17 브러쉬 롤이 막히면 ERGORAPIDO®가 멈춥니다. 케이블 보호 그릴 및 브러쉬 롤 해치 커버를 열고 브러쉬 롤을 분리하십시오.
- 18 가위를 사용해 실을 제거하십시오. 브러쉬 롤을 재조립하고 부드럽게 회전하는지 확인하십시오.

재활용을 위한 배터리 분리

경고: 배터리 분리는 Electrolux 서비스 센터나 공식 수거 센터에서만 수행해야 합니다!

- 19 배터리는 제품을 폐기해야 할 경우에만 분리하십시오. 배터리를 잘못 취급하면 위험할 수 있습니다. 배터리는 분리하기 전에 완전히 방전시켜야 합니다. 제품을 재활용을 위해 Electrolux 서비스 센터나 공식 수거 센터로 가져가십시오. 이들은 안전하고 전문적인 방식으로 배터리 및 전기 부품을 분리하여 재생할 수 있습니다. 충전지 및 전기 제품 수거에 대한 거주 국가 규정을 따르십시오.

ERGORAPIDO®와 함께 멋진 청소 경험을 누리세요!

안전 주의 사항

이 제품은 안전에 관하여 책임이 있는 사람이 제품 사용에 관한 감독 또는 지시를 하는 경우를 제외하면 신체, 감각 또는 지적 능력이 낮거나 경험과 지식이 부족한 사람(어린이 포함)은 사용할 수 없습니다.

어린이가 제품을 가지고 놀지 못하도록 해야 합니다.

제함을 폐기하기 전에 먼저 배터리를 분리해야 합니다.

배터리는 안전하게 폐기해야 합니다.

제품과 함께 제공된 충전용 어댑터만 사용하십시오.

ERGORAPIDO® 는 실내 및 가정에서의 일반 진공 청소로만 사용해야 합니다. 건조한 장소에 보관하십시오. 질식을 방지하기 위해 아이들이 비닐 백과 같은 포장재에 접근하지 못하도록 하십시오.

- 다음과 같은 경우에는 절대 진공 청소기를 사용하지 마십시오.
- 공간이 습한 경우.
 - 가연성 가스 가까이 있는 경우.
 - 제품이 손상된 징후가 보이는 경우.
 - 날카로운 물체 또는 액체가 있는 경우.
 - 뜨겁거나 식은 재, 불씨가 있는 담배 공초 등이 있는 경우.
 - 석고, 콘크리트 먼지, 밀가루, 뜨겁거나 식은 재와 같은 먼지가 있는 경우

주의:

- 직사광선에 진공 청소기를 방치하지 마십시오.
- 강한 열기에 진공 청소기를 노출시키지 마십시오.
- 내장된 배터리 셀을 분해하거나 단락시키거나 금속 표면에 올려두면 안됩니다.
- 필터를 제거한 채로는 절대 진공 청소기를 사용하지 마십시오.
- 청소기가 켜져있고 브러시 롤이 회전하는 중에 브러시 롤에 손을 대지 마십시오.
- 바닥 노출 내부를 청소할 때는 손가락을 조심하십시오. BRUSHROLLCLEAN® 기능의 금속날이 날카로워 다칠 수 있습니다.

위의 환경에서 진공 청소기를 사용할 경우 심각한 부상을 입거나 제품 손상을 가져올 수 있습니다. 이러한 부상 또는 손상에 대해서는 Electrolux의 보증 서비스를 받을 수 없습니다.

서비스 및 보증

모든 서비스나 수리는 공식 Electrolux 서비스 센터에서 수행해야 합니다.

배터리 수명은 사용량과 자연 방전 등에 따라 달라집니다. 때문에 배터리 수명 또는 사용으로 인한 작동 시간 감소는 보증 수리에 해당되지 않습니다.

모터, 배터리 및 전자 부품을 보호하기 위해 다음과 같은 환경에서의 제품 보관 또는 동작을 피해야 합니다:

- 5°C 미만이나 35°C초과 주변 온도, 5°C 미만이나 35°C 초과 온도에서 제품을 보관한 경우, 제품을 사용하기 전에 온도를 낮추거나 따뜻하게 하고 몇 시간 동안 건조시키십시오.
- 20% 미만이나 80% 초과 습도(비응축).

제품을 장기간 보관할 경우(사용 또는 지속적인 충전 없이) 배터리를 50% 이상 충전한 상태로 일반적인 실내 온도에 보관하는 것이 좋습니다. 이렇게 하면 제품 성능이 유지됩니다.

주의! 찬 곳에서 따뜻한 곳으로 옮기거나 보관 온도를 높일 경우 제품 내부에 결로가 생길 수 있습니다. 사용하기 전에 내부 구성부품 온도가 상승하여 건조될 때까지 몇 시간 기다리십시오.

표시등

충전 중 	무슨 의미입니까?	사용 중	무슨 의미입니까?
	천천히 깜박임 = 100% 완전히 충전됨		75-100% 용량
	50-95% 충전됨		50-75% 용량 남음
	0-50% 충전됨		25-50% 용량 남음
			ERGORAPIDO®를 충전해야 합니다.

홈페이지를 이용하십시오:



사용 방법 지침, 브로셔, 문제 해결 방법,
서비스 정보 확보: www.electroluxconsumer.co.kr



더 많은 제품 정보:
www.electrolux.co.kr



제품 액세서리 및 소모품 구입:
www.electroluxshop.co.kr

고객 관리 및 서비스

Electrolux 서비스 센터에 연락할 때는
다음 데이터를 준비하십시오.

- 모델 번호
- PNC 번호
- 시리얼 번호

해당 정보는 라벨에 적혀 있습니다.

모델 번호

PNC 번호

시리얼 번호

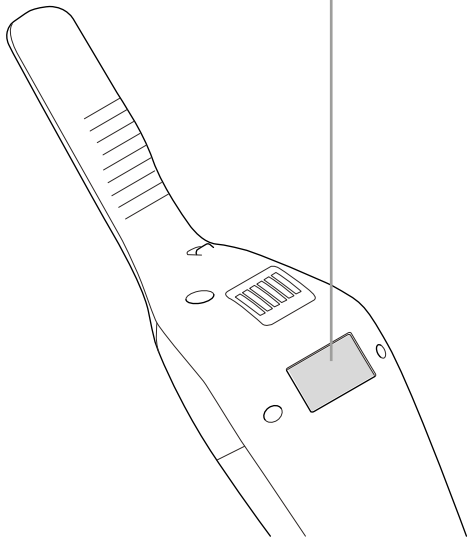
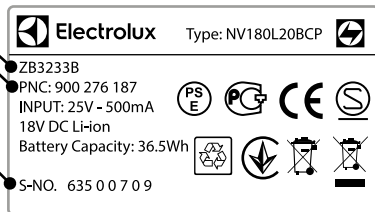

소모품 및 액세서리



www.electroluxshop.co.kr

필터
참조 코드: EF150
PNC: 900 168 3748



차량용 키트
참조 코드: KIT10A
PNC: 900 167 1677

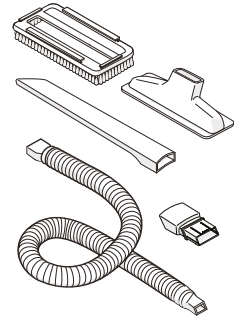

BedPro™ MINI
참조 코드: ZE125
PNC: 900 168 0819

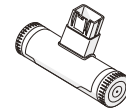

ERGORAPIDO® 작동 시간

실제 사용 시간은 사용 환경에 따라 달라질 수 있습니다.

볼트	파워 모드	일반 모드
14,4V	약 16 분	약 42 분
18V	약 16 분	약 48 분

배터리 수명은 사용량과 자연 방전 등에 따라 달라집니다. 때문에 배터리 수명 또는 사용으로 인한 작동 시간 감소는 보증 수리에 해당되지 않습니다.



이 기호는 이 제품에 일반 가정용 폐기물로 버릴 수 없는 내장형 충전지가 들어 있음을 나타냅니다.



제품 또는 포장에 이 기호가 있으면 이 제품을 가정용 폐기물로 처리할 수 없다는 표시입니다.



제품을 재활용하려면 안전하고 전문적인 방식으로 배터리 및 전기 부품을 분리할 수 있는 공식 수거 장소 또는 Electrolux 서비스 센터에 가져가십시오. 전기 제품 및 충전지 분리 수거를 위한 거주 국가의 규정에 따르십시오.

ภาษาไทย

ขอขอบคุณที่เลือกซื้อเครื่องดูดฝุ่นรุ่น ERGORAPIDO® ของอีเลคโทรลักซ์ โปรดใช้อุปกรณ์เสริมและชิ้นส่วนอะไหล่แท้ของอีเลคโทรลักซ์เสมอเพื่อประสิทธิภาพการทำงานที่ดีที่สุด เนื่องจากได้รับการออกแบบมาเพื่อเครื่องดูดฝุ่นรุ่นนี้โดยเฉพาะ ผลิตภัณฑ์ที่นี้ออกแบบมาโดยตระหนักถึงความสำคัญของสิ่งแวดล้อม ชิ้นส่วนพลาสติกทั้งหมดจะมีสัญลักษณ์เพื่อการรีไซเคิล

คำอธิบาย ERGORAPIDO®

- A. ปุ่มเปิด/ปิด
- B. ปุ่มควบคุมแรงดูด
- C. ปุ่มเปิด/ปิด ส่วนด้ามจับ
- D. สกรูล็อก
- E. ปุ่มถอดส่วนด้ามจับ
- F. แท่นชาร์จ แท่นติดตั้ง
- G. แท่นชาร์จ ฐานวางบนพื้น
- H. อะแดปเตอร์ชาร์จไฟ
- I. ตัวกรองละเอียด (ตัวกรองชั้นใน)
- J. ตัวกรองหยาบ (ตัวกรองชั้นนอก)
- K. ปุ่มถอดกล่องเก็บฝุ่น
- L. กล่องเก็บฝุ่น
- M. หัวแปรง
- N. หัวดูดปากแคม
- O. ตะแกรงป้องกันสายไฟ
- P. ฝาปิดแปรงลูกกลิ้ง
- Q. แปรงลูกกลิ้ง
- R. เป็นเหยียบ
- BRUSHROLLCLEAN®
- S. ไฟด้านหลังหัวดูด
- T. ไฟแสดงสถานะการชาร์จ
- U. ช่องแขวน
- V. ช่องสำหรับเก็บอุปกรณ์เสริม

ก่อนเริ่มใช้งาน

โปรดตรวจสอบว่าในกล่องบรรจุภัณฑ์มีชิ้นส่วนครบทั้งหมดตามที่ระบุในคู่มือการใช้งาน และอ่านคู่มืออย่างละเอียด ใส่ใจต่อข้อควรระวังเพื่อความปลอดภัยเป็นพิเศษ ปฏิบัติตามคำแนะนำเหล่านี้

รูปภาพหน้า 2

- 1 ประกอบด้ามจับ
- 2 ประกอบแท่นชาร์จ
- 3 ใต้แท่นชาร์จมีช่องสำหรับเก็บสายไฟที่ไม่ได้ใช้ เสียขอะแดปเตอร์เข้ากับแหล่งจ่ายไฟและวางแท่นชาร์จบนพื้นผิวแนวราบที่มั่นคง ห่างจากแหล่งความร้อนและแสงไฟที่ส่องลงโดยตรง หรือพื้นผิวเปียก
- 4 ไฟแสดงสถานะการชาร์จจะติดเมื่อวาง ERGORAPIDO® ลงในแท่นชาร์จ

รูปภาพหน้า 3

การชาร์จ ERGORAPIDO®

- 5 เมื่อชาร์จจนเต็มแล้ว ไฟแสดงสถานะการชาร์จจะกะพริบซ้ำๆ จำนวนดวงไฟแอลอีดีจะแสดงระดับการชาร์จ การชาร์จเต็มใช้เวลาประมาณ 4 ชั่วโมงเพื่อการทำงานของแบตเตอรี่อย่างมีประสิทธิภาพ ชาร์จ ERGORAPIDO® เป็นเวลา 24 ชั่วโมงก่อนการใช้งานครั้งแรก และชาร์จไว้เสมอเมื่อไม่มีการใช้งาน

การดูดฝุ่นด้วย ERGORAPIDO®

ก่อนการดูดฝุ่น ให้ตรวจสอบว่าล้อของหัวดูดและแปรงลูกกลิ้งสะอาดปราศจากของมีคมเพื่อไม่ให้ขีดข่วนพื้นเป็นรอยและเพื่อประสิทธิภาพในการทำ ความสะอาดอย่างเต็มที่

- 6 เริ่มและหยุด ERGORAPIDO® โดยการกดปุ่มเปิด/ปิด ERGORAPIDO® จะเริ่มทำงานในโหมดกำลังสูง ให้กดปุ่มควบคุมแรงดูดสำหรับการทำความสะอาดที่เรียบกว่าเดิมและการใช้งานที่ยาวนานขึ้น

การดูดฝุ่นเฟอร์นิเจอร์ เบาะรถยนต์ ฯลฯ

- 7 กดปุ่มเพื่อถอดด้ามจับออกจากตัวเครื่อง
- 8 ติดตั้งหัวดูดปากแคมเพื่อความสะอาดกในการทำความสะอาดบริเวณที่เข้าถึงได้ยาก ติดตั้งแปรงบนหัวดูดปากแคมเพื่อปิดฝุ่น
- 9 สามารถจัดเก็บหัวดูดปากแคมและแปรงเล็กในแท่นชาร์จหรือในช่องด้านหลังของด้ามจับ

ฟิงก์ซัน BRUSHROLLCLEAN®

ใช้ฟิงก์ซัน BRUSHROLLCLEAN® เพื่อช่วยไม่ให้เส้นผมหรือเส้นใยติดบนแปรงลูกกลิ้ง เพื่อผลลัพธ์ที่ดีที่สุด ควรใช้ฟิงก์ซัน BRUSHROLLCLEAN® เมื่อชาร์จ ERGORAPIDO® จนเต็ม

- 10 วาง ERGORAPIDO® บนพื้นผิวแข็งและเรียบเสมอกัน ห้ามใช้ฟิงก์ซัน BRUSHROLLCLEAN® กับพื้นพรม ใช้เท่ากอดแป้น BRUSHROLLCLEAN® ขณะที่เครื่องดูดฝุ่นเปิดทำงาน อยู่ กดค้างไว้ 5 วินาที จนกระทั่งเส้นผมและเส้นใยหลุดออกมา ระหว่างกระบวนการนี้อาจมีเสียงดังเกิดขึ้น ซึ่งเป็นเรื่องปกติ หากยังมีเส้นผมหลงเหลือบริเวณแปรงลูกกลิ้ง ให้ทำซ้ำตามขั้นตอนเดิม ฟิงก์ซัน BRUSHROLLCLEAN® มาพร้อมกับการป้องกันความร้อนสูงเกิน หากมีการใช้ฟิงก์ซัน BRUSHROLLCLEAN® นานกว่า 30 วินาที (อย่างต่อเนื่องหรือขาดช่วง) แปรงลูกกลิ้งจะหยุดทำงานและปิดไฟด้านหลังหัวดูด เครื่องดูดฝุ่นจะยังสามารถใช้งานได้ แม้ในขณะที่ฟิงก์ซัน BRUSHROLLCLEAN® หยุดทำงาน เพื่อให้ฟิงก์ซัน BRUSHROLLCLEAN® กลับมาทำงานอีกครั้ง ให้วาง ERGORAPIDO® บนที่ชาร์จ และชาร์จไฟเป็นเวลา 15 นาที

โปรดทราบว่าฟิงก์ซัน BRUSHROLLCLEAN® อาจไม่สามารถกำจัดเส้นด้ายหนาหรือลวดที่ติดอยู่ในแปรงลูกกลิ้งออกไปได้

การเทฝุ่นในกล่องเก็บฝุ่น

- 11 ถอดกล่องเก็บฝุ่นโดยการกดปุ่ม
- 12 ถอดตัวกรองออกจากกล่องเก็บฝุ่นโดยการกดปุ่มปลดล๊อค เทฝุ่นในกล่องลงในถังขยะ ห้ามล้างทำความสะอาดกล่องเก็บฝุ่นหรือตัวกรองในเครื่องล้างจาน

ข้อมูลสำคัญ - การทำความสะอาดตัวกรอง!

- 13 ต้องทำความสะอาดตัวกรองเป็นประจำเพื่อให้อายุการใช้งานสูง ดึงตัวกรองออกโดยการกดปุ่มปลดล๊อค แยกตัวกรองชั้นในออกจากตัวกรองชั้นนอก
- 14 ล้างชิ้นส่วนตัวกรองอย่างระมัดระวังด้วยน้ำอุ่นโดยไม่ต้องใช้น้ำยาทำความสะอาด (ห้ามใช้เครื่องล้างจานหรือเครื่องซักผ้า) เชยตัวกรองเพื่อไล่น้ำส่วนเกินออก จากนั้นผึ่งให้แห้งอย่างน้อย 12 ชั่วโมง ก่อนที่จะประกอบกลับเข้าไปในเครื่องดูดฝุ่น

การทำความสะอาดท่ออ่อนและล้อของหัวดูด

- 15 หมุนท่ออ่อนหลังหัวดูดจากข้อต่อบน ดึงวัตถุหรือเศษที่อาจอุดตันของลมในท่ออ่อนออกหรือในช่องลมถึงถ้วยกรองฝุ่นออก จากนั้นเสียบท่ออ่อนกลับเข้าไปตั้งเดิม
- 16 ถ้าวาล์วขัดหรือต้องนำไปทำความสะอาด ให้ค่อยๆ ถอดออกอย่างระมัดระวังโดยใช้ไขควงปากแบน

การถอดและการทำความสะอาดแปรงลูกกลิ้ง

- 17 ถ้าวาล์วลูกกลิ้งอุดตัน ERGORAPIDO® จะหยุดทำงาน เปิดตะแกรงป้องกันสายไฟและฝาครอบแปรงลูกกลิ้ง จากนั้นถอดแปรงลูกกลิ้งออก
- 18 ใช้กรรไกรตัดเส้นด้าย และเศษอื่นๆ ประกอบแปรงลูกกลิ้งกลับเข้าไปใหม่ โดยตรวจสอบว่าสามารถลึงได้ตามปกติ

การถอดแบตเตอรี่เพื่อการรีไซเคิล

คำเตือน การถอดแบตเตอรี่ต้องทำโดยศูนย์บริการอีเลคโทรลักซ์หรือสถานที่รับคัดแยกขยะที่เป็นทางการเท่านั้น!
ถอดแบตเตอรี่เมื่อจะทำการทิ้งผลิตภัณฑ์เท่านั้น การกำจัดแบตเตอรี่อย่างไม่เหมาะสมอาจทำให้เกิดอันตรายได้ **ควรคายประจุแบตเตอรี่ก่อนทำการถอดเสมอ** นำผลิตภัณฑ์ไปส่งที่ศูนย์บริการอีเลคโทรลักซ์หรือสถานที่รับคัดแยกขยะที่เป็นทางการเพื่อการรีไซเคิล พนักงานสามารถถอดและรีไซเคิลแบตเตอรี่ รวมถึงชิ้นส่วนไฟฟ้าได้อย่างปลอดภัยและเป็นมืออาชีพ โปรดปฏิบัติตามหลักเกณฑ์ในการเก็บแบตเตอรี่ชนิดชาร์จซ้ำและอุปกรณ์ไฟฟ้าที่กำหนดในประเทศของคุณ

ขอให้สนุกกับประสบการณ์การทำความสะอาดกับเครื่องดูดฝุ่น ERGORAPIDO®!

อีเลคโทรลักซ์สงวนสิทธิ์ในการเปลี่ยนแปลงผลิตภัณฑ์ ข้อมูล และข้อมูลเฉพาะโดยไม่ต้องแจ้งให้ทราบล่วงหน้า

ข้อควรระวังเพื่อความปลอดภัย

อุปกรณ์นี้ไม่ได้ออกแบบมาสำหรับการใช้งานโดยบุคคล (รวมถึงเด็ก) ผู้มีความบกพร่องทางร่างกาย ทางประสาทสัมผัสหรือทางจิต รวมถึงผู้ที่ขาดประสบการณ์และความรู้ เว้นแต่จะอยู่ภายใต้การดูแล หรือการแนะนำเกี่ยวกับการใช้อุปกรณ์โดยผู้ที่รับผิดชอบความปลอดภัยของบุคคลเหล่านั้น

ควรดูแลไม่ให้เด็กเล่นอุปกรณ์นี้

ถอดแบตเตอรี่ออกก่อนทิ้งเครื่องใช้ไฟฟ้านี้

แบตเตอรี่ต้องนำไปทิ้งอย่างปลอดภัย

ใช้อะแดปเตอร์ชาร์จไฟที่เข้ากับผลิตภัณฑ์เท่านั้น

ควรใช้เครื่องดูดฝุ่น ERGORAPIDO® ในการทำความสะอาดสภาพแวดล้อมในร่มและภายในบ้านตามปกติเท่านั้น ตรวจสอบให้แน่ใจว่าเก็บเครื่องดูดฝุ่นไว้ในที่แห้ง

เก็บวัสดุบรรจุภัณฑ์ทั้งหมด เช่น ถุงพลาสติก ให้ห่างจากมือเด็กเพื่อป้องกันการขาดอากาศหายใจ

ห้ามใช้งานเครื่องดูดฝุ่น:

- ในพื้นที่เปียก
- ใกล้กับก๊าซไวไฟ ฯลฯ
- เมื่อผลิตภัณฑ์มีร่องรอยของความเสียหาย
- ใช้ดูดของมีคมหรือของเหลว
- ใช้ดูดซีเมนต์แห้งร้อนและเย็น ก้อนหกรูที่ติดไฟ ฯลฯ
- ใช้ดูดฝุ่นผงละเอียด เช่น ปูนปลาสเตอร์ คอนกรีต ผงแป้ง ซีเมนต์แห้งร้อน และเย็น

ข้อควรระวัง:

- อย่าวางเครื่องดูดฝุ่นให้สัมผัสกับแสงแดดโดยตรง
- หลีกเลี่ยงการวางเครื่องดูดฝุ่นให้สัมผัสกับความชื้น
- อย่านกดหรือขูดแบตเตอรี่ภายในเครื่อง ทำให้เกิดการลัดวงจร หรือวางไว้บนพื้นผิวโลหะ
- ห้ามใช้เครื่องดูดฝุ่นโดยไม่มีตัวกรอง
- อย่ำสัมผัสแปรงลูกกลิ้งในขณะที่เปิดใช้งานเครื่องดูดฝุ่น และในขณะที่แปรงลูกกลิ้งหมุนอยู่
- ระวังนิ้วมือเมื่อทำความสะอาดภายในหัวดูดฝุ่นสำหรับพื้น ไม้พืดโลหะของฟังก์ชัน BRUSHROLLCLEAN® มีความคมและอาจทำให้ได้รับบาดเจ็บได้

การใช้งานเครื่องดูดฝุ่นในสภาวะแวดล้อมข้างต้นอาจทำให้ได้รับบาดเจ็บร้ายแรงต่อบุคคลหรือทำให้ผลิตภัณฑ์ชำรุดเสียหาย ซึ่งการบาดเจ็บและความเสียหายในลักษณะนี้ไม่ได้ครอบคลุมอยู่ในการรับประกันหรือในขอบเขตของอีเลคโทรลักซ์

การให้บริการและการรับประกัน

บริการหรือการซ่อมบำรุงทั้งหมดจะต้องดำเนินการโดยศูนย์บริการอย่างเป็นทางการของอีเลคโทรลักซ์

การรับประกันไม่ได้ครอบคลุมถึงระยะเวลาการใช้งานแบตเตอรี่ที่ลดลงอันเนื่องมาจากอายุการใช้งานหรือลักษณะการใช้งาน ทั้งนี้เพราะอายุการใช้งานแบตเตอรี่จะขึ้นอยู่กับลักษณะและจำนวนครั้งที่ใช้งาน

ไฟแสดงสถานะ

ระหว่างการชาร์จ	ความหมาย	ระหว่างการใช้งาน	ความหมาย
	กะพริบช้าๆ = ชาร์จเต็ม 100 %		ความจุ 75 - 100 %
	ชาร์จแล้ว 50 - 95 %		ความจุที่เหลือ 50 - 75 %
	ชาร์จแล้ว 0 - 50 %		ความจุที่เหลือ 25 - 50 %
			ERGORAPIDO® จำเป็นต้องชาร์จแบตเตอรี่ใหม่

เพื่อป้องกันมอเตอร์ แบตเตอรี่ อิเล็กทรอนิกส์ ไม่ควรเก็บหรือใช้งานผลิตภัณฑ์ใน:

- อุณหภูมิโดยรอบต่ำกว่า 5°C หรือสูงกว่า 35°C หากจัดเก็บผลิตภัณฑ์ในอุณหภูมิต่ำกว่า 5°C หรือสูงกว่า 35°C ปล่อยให้ผลิตภัณฑ์เย็นลงหรืออุ่นขึ้นและแห้งสองถึงสามชั่วโมงก่อนการใช้งาน
- ระดับความชื้นต่ำกว่า 20% หรือสูงกว่า 80% (ไม่ควบคุม)

หากจัดเก็บผลิตภัณฑ์เป็นระยะเวลาสั้น (โดยไม่มีการใช้งานหรือการชาร์จอย่างต่อเนื่อง) เราแนะนำให้จัดเก็บผลิตภัณฑ์ในอุณหภูมิห้องปกติ พร้อมกับแบตเตอรี่ที่ชาร์จแล้ว 50% หรือมากกว่า วิธีนี้จะรักษาประสิทธิภาพของผลิตภัณฑ์ไว้

ข้อควรระวัง! การควบคุมเป็นหยดน้ำค้างอาจเกิดขึ้นภายในผลิตภัณฑ์ ถ้าอุปกรณ์ถูกเคลื่อนย้ายจากสภาพแวดล้อมเย็นไปอุ่น หรือหลังจากทำให้ห้องเก็บของร้อนขึ้น รอประมาณสองถึงสามชั่วโมงเพื่อให้ชิ้นส่วนภายในอุ่นขึ้นและแห้งสนิทก่อนใช้งาน

ไปที่เว็บไซต์ของเราเพื่อ:



รับคำแนะนำการใช้งาน โบรชัวร์ ช่างซ่อม และข้อมูลการให้บริการที่: www.electrolux.com



ลงทะเบียนผลิตภัณฑ์เพื่อรับบริการที่ดียิ่งขึ้น:
www.electrolux.com/productregistration



ซื้ออุปกรณ์เสริมและวัสดุสิ้นเปลืองสำหรับเครื่องดูดฝุ่นของคุณที่: www.electrolux.com/shop

การดูแลและบริการลูกค้า

เมื่อติดต่อศูนย์บริการลูกค้าอีเลคโทรลักซ์ คุณจะต้องมีข้อมูลต่อไปนี้:

- หมายเลขรุ่น
- หมายเลข PNC
- หมายเลขผลิตภัณฑ์

สามารถดูข้อมูลเหล่านี้ได้ที่แผ่นป้ายระบุค่าพิกัด

หมายเลขรุ่น

หมายเลข PNC

หมายเลข
ผลิตภัณฑ์

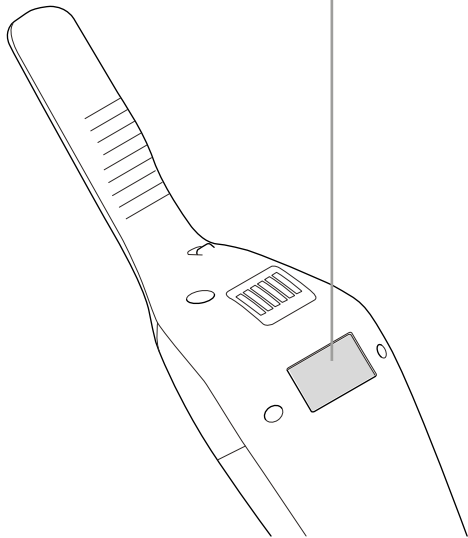
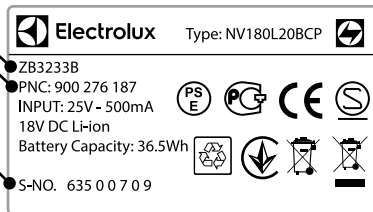

วัสดุสิ้นเปลืองและอุปกรณ์เสริม



www.electrolux.com/shop

ตัวกรอง
Ref: EF150
PNC: 900 168 3748



ชุดดูดฝุ่นในรถยนต์
Ref: KIT10A
PNC: 900 167 1677

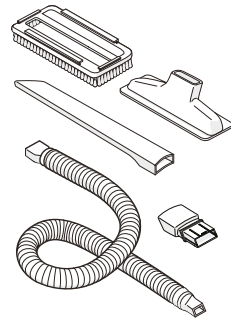

BedPro™ MINI
Ref: ZE125
PNC: 900 168 0819

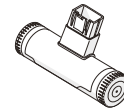

เวลาที่ใช้ในการทำงานสำหรับ ERGORAPIDO®

ระยะเวลาทำงานของเครื่องจะสั้นหรือยาวขึ้นอยู่กับการใช้งานเป็นหลัก

โวลต์	โหมดกำลังสูง	โหมดการใช้งานยาวนาน
14.4 โวลต์	16 นาที โดยประมาณ	42 นาที โดยประมาณ
18 โวลต์	16 นาที โดยประมาณ	48 นาที โดยประมาณ

การรับประกันไม่ได้ครอบคลุมถึงระยะเวลาการใช้งานแบตเตอรี่ที่ลดลงอันเนื่องมาจากอายุการใช้งานหรือลักษณะการใช้งาน ทั้งนี้เพราะอายุการใช้งานแบตเตอรี่จะขึ้นอยู่กับลักษณะและจำนวนครั้งที่ใช้งาน



สัญลักษณ์ที่ตัวผลิตภัณฑ์นี้บ่งชี้ว่า ผลิตภัณฑ์นี้มีแบตเตอรี่ชนิดชาร์จซ้ำได้ติดตั้งมาพร้อมตัวเครื่อง ซึ่งอาจไม่สามารถกำจัดทิ้งร่วมกับขยะในครัวเรือนตามปกติได้



สัญลักษณ์ที่ตัวผลิตภัณฑ์หรือบรรจุภัณฑ์นี้บ่งชี้ว่าผลิตภัณฑ์นี้อาจไม่สามารถจัดการแบบเดียวกับขยะในครัวเรือนได้

หากต้องการรีไซเคิลผลิตภัณฑ์ โปรดนำผลิตภัณฑ์ไปส่งที่สถานที่รับคัดแยกขยะที่เป็นทางการ หรือศูนย์บริการอีเลคโทรลักซ์ที่สามารถถอดและนำแบตเตอรี่ รวมถึงชิ้นส่วนไฟฟ้าไปรีไซเคิลได้อย่างปลอดภัยและเป็นมืออาชีพ ปฏิบัติตามหลักเกณฑ์ในการแยกเก็บอุปกรณ์ไฟฟ้าและแบตเตอรี่ชนิดชาร์จซ้ำที่กำหนดในประเทศของคุณ

TIẾNG VIỆT

Cảm ơn bạn đã lựa chọn sản phẩm máy hút bụi Electrolux ERGORAPIDO®. Để đảm bảo kết quả tốt nhất, luôn sử dụng các phụ kiện và phụ tùng Electrolux chính hãng. Các bộ phận và phụ tùng này được thiết kế đặc biệt để sử dụng cho máy hút bụi của bạn. Sản phẩm này được thiết kế có cân nhắc tới yếu tố bảo vệ môi trường. Tất cả các bộ phận bằng nhựa được đánh dấu để phục vụ mục đích tái chế.

MÔ TẢ ERGORAPIDO®

- | | |
|-------------------------------|----------------------------|
| A. Nút BẬT/TẮT | M. Chổi quét bụi |
| B. Nút chỉnh công suất | N. Đầu hút khe hẹp |
| C. Nút BẬT/TẮT, trên tay cầm | O. Lưới bảo vệ dây |
| D. Vít khóa | P. Nắp che chổi lăn |
| E. Nút tháo trên tay cầm | Q. Chổi lăn |
| F. Giá sạc treo tường | R. Bàn đạp BRUSHROLLCLEAN® |
| G. Giá sạc dưới sàn | S. Đèn phía trước đầu hút |
| H. Củ sạc | T. Đèn báo sạc |
| I. Bộ lọc tinh (Bộ lọc trong) | U. Móc treo |
| J. Bộ lọc thô (Bộ lọc ngoài) | V. Khe cất giữ phụ kiện |
| K. Nút tháo hộp chứa bụi | |
| L. Hộp chứa bụi | |

TRƯỚC KHI KHỞI ĐỘNG

Kiểm tra để đảm bảo rằng gói sản phẩm đã bao gồm đầy đủ các bộ phận mô tả trong sách hướng dẫn này và đọc kỹ sách hướng dẫn này. Đặc biệt lưu ý chương các biện pháp an toàn. Lưu lại các hướng dẫn này.

Hình trang 2

- 1 Lắp tay cầm.
- 2 Lắp đế sạc.
- 3 Bên dưới đế sạc có hộc để quấn dây cáp khi không sử dụng. Cắm củ sạc vào ổ điện và đặt giá sạc lên bề mặt ngang và chắc chắn, cách xa các nguồn nhiệt, ánh nắng trực tiếp và các nơi ẩm ướt.
- 4 Đèn báo sạc sẽ phát ra ánh sáng màu cam khi ERGORAPIDO® được đặt vào giá sạc.

Hình trang 3

SẠC PIN ERGORAPIDO®

- 5 Khi pin được sạc đầy, đèn báo sạc sẽ nhấp nháy chậm. Các số hiển thị trên đèn LED cho biết mức sạc. Thời gian sạc đầy pin là xấp xỉ 4 giờ. Để pin đạt tuổi thọ lâu hơn, sạc ERGORAPIDO® trong 24 giờ trước khi sử dụng lần đầu và luôn sạc pin khi không sử dụng.

HÚT BỤI VỚI ERGORAPIDO®

Trước khi hút bụi, đảm bảo bánh xe ở đầu hút và chổi lăn đã sạch, không có các vật sắc nhọn để tránh làm xước sàn nhà và để đảm bảo hiệu suất làm sạch tối đa.

- 6 Khởi động và dừng ERGORAPIDO® bằng cách nhấn nút BẬT/TẮT. ERGORAPIDO® sẽ khởi động ở chế độ công suất cao. Để vệ sinh ở chế độ im lặng và thời gian sử dụng lâu hơn, nhấn nút chỉnh công suất.

HÚT BỤI NỘI THẤT, GHÉ XE HƠI, V.V..

- 7 Nhấn nút để nhả tay cầm khỏi phần thân máy.
- 8 Lắp đầu hút khe hẹp để vệ sinh những chỗ khó với tới. Gắn chổi vào đầu hút khe hẹp để quét bụi.
- 9 Có thể cất giữ đầu hút khe hẹp và chổi nhỏ trong đế sạc hoặc trong khe ở mặt sau của tay cầm.

CHỨC NĂNG BRUSHROLLCLEAN®

Sử dụng nút BRUSHROLLCLEAN® để giữ cho chổi lăn luôn sạch và không quấn phải tóc hay sợi. Để hiệu quả nhất, sử dụng chức năng BRUSHROLLCLEAN® sau khi sạc đầy pin cho ERGORAPIDO®.

- 10 Đặt ERGORAPIDO® trên bề mặt cứng và bằng phẳng. Không sử dụng chức năng BRUSHROLLCLEAN® trên thảm. Dùng chân nhấn bàn đạp BRUSHROLLCLEAN® sau khi bật máy hút bụi. Giữ trong 5 giây đến khi tóc hay sợi được gỡ ra. Bình thường sẽ có một tiếng cạt trong quá trình này. Nếu vẫn còn tóc trong chổi lăn, lặp lại quá trình này. Chức năng BRUSHROLLCLEAN® có khả năng bảo vệ quá nhiệt. Sau khi sử dụng chức năng BRUSHROLLCLEAN® trong hơn 30 giây (liên tục hoặc gián đoạn), chổi lăn sẽ dừng hoạt động và đèn phía trước vòi hút sẽ tắt. Vẫn có thể sử dụng máy hút bụi ngay cả

khi chức năng BRUSHROLLCLEAN® đã tắt. Để kích hoạt lại chức năng BRUSHROLLCLEAN®, đưa ERGORAPIDO® lên để sạc và sạc trong 15 phút.

Vui lòng lưu ý rằng chức năng BRUSHROLLCLEAN® có thể không gỡ được các sợi hay dây lớn hơn bị quấn vào chổi lăn.

ĐÓ HỘP CHỨA BỤI.

- 11 Tháo hộp chứa bụi bằng cách ấn các nút.
- 12 Tháo bộ lọc ra khỏi hộp chứa bụi bằng cách ấn các nút tháo. Đổ hết bụi trong hộp vào thùng rác. Không rửa hộp chứa bụi hoặc bộ lọc bằng nước rửa bát.

QUAN TRỌNG – LÀM SẠCH BỘ LỌC!

- 13 Bộ lọc phải được làm sạch định kỳ để đảm bảo hiệu suất làm sạch cao. Lấy bộ lọc ra bằng cách ấn các nút tháo. Gỡ riêng bộ lọc trong ra khỏi bộ lọc ngoài.
- 14 Súc rửa kỹ các bộ phận của bộ lọc dưới vòi nước ấm nhưng không được dùng chất tẩy rửa. (Không được sử dụng máy rửa bát hay máy giặt). Lắc cho ra hết nước và để khô trong thời gian ít nhất 12 giờ mới được lắp trở lại máy hút bụi.

VỆ SINH ỐNG HÚT VÀ BÁNH XE ĐẦU HÚT

- 15 Nới lỏng ống hút phía sau đầu hút khỏi điểm nối trên. Loại bỏ bất cứ vật thể hoặc mảnh vỡ nào có thể làm gián đoạn dòng khí trong ống hút hoặc trong ống thông khí vào phễu bụi và đặt ống hút lại đúng vị trí.
- 16 Nếu bánh xe bị kẹt hoặc cần được làm sạch, hãy tháo chúng cẩn thận bằng cách sử dụng tua vít dẹt.

THÁO VÀ VỆ SINH CHỔI LĂN

- 17 Nếu chổi lăn bị kẹt ERGORAPIDO® sẽ dừng hoạt động. Mở lưới bảo vệ dây và nắp che chổi lăn và tháo chổi lăn ra.
- 18 Dùng kéo để lấy tóc/sợi ra. Lắp lại chổi lăn sao cho chổi có thể quay dễ dàng.

THÁO PIN ĐỂ TIÊU HỦY

Cảnh báo; Chỉ trung tâm dịch vụ ủy quyền của Electrolux hoặc một điểm thu gom chính thức mới được tháo và tiêu hủy pin!

- 19 Chỉ tháo pin ra nếu có ý định tiêu hủy sản phẩm. Tháo pin không đúng cách có thể gây nguy hiểm. **Phải xả hết điện trong pin trước khi tháo.** Đưa ra sản phẩm đến một trung tâm dịch vụ của Electrolux hoặc một điểm thu gom chính thức để tái chế. Tại đây họ có thể tháo và tái chế pin và các bộ phận điện một cách an toàn và chuyên nghiệp. Tuân thủ các quy định của quốc gia sở tại về thu gom riêng các sản phẩm điện và pin sạc.

Tận hưởng trải nghiệm vệ sinh tuyệt vời với ERGORAPIDO®!

Electrolux có quyền thay đổi sản phẩm, thông tin và các thông số kỹ thuật và không cần phải thông báo.

CÁC BIỆN PHÁP AN TOÀN

Thiết bị này không được thiết kế để sử dụng bởi các cá nhân (kể cả trẻ em) có khuyết tật về thể chất, cảm giác hoặc thần kinh, hoặc thiếu kinh nghiệm và kiến thức, trừ khi họ được giám sát hoặc chỉ dẫn sử dụng thiết bị bởi người chịu trách nhiệm về sự an toàn của họ.

Trẻ em phải được giám sát để đảm bảo chúng không nghịch thiết bị này.

Phải tháo pin khỏi thiết bị trước khi tiêu hủy.

Pin phải được tiêu hủy an toàn.

Chỉ nên sử dụng củ sạc đi kèm với sản phẩm.

Chỉ nên sử dụng ERGORAPIDO® để hút bụi thông thường ở môi trường trong nhà. Đảm bảo rằng máy hút bụi được cất giữ ở nơi khô ráo.

Không để các vật liệu đóng gói như túi nhựa gần tầm tay trẻ em để tránh gây nghẹt thở.

Không sử dụng máy hút bụi:

- Ở khu vực ẩm ướt.
- Gần các loại khí dễ cháy, v.v..
- Khi sản phẩm có dấu hiệu hư hỏng rõ ràng.
- Trên các vật sắc nhọn hoặc chất lỏng.
- Trên xỉ than nóng hoặc nguội, mẫu thuốc lá đang cháy, v.v..
- Trên bụi mịn, như thạch cao, bê tông, bột mì, xỉ than nóng hoặc nguội.

Thận trọng:

- Không được để máy hút bụi tiếp xúc trực tiếp với ánh nắng mặt trời.
- Tránh để máy hút bụi tiếp xúc với nguồn nhiệt mạnh.
- Không được tháo pin, gây đoản mạch hay đặt pin trên bề mặt kim loại.
- Không sử dụng máy hút bụi khi không có các bộ lọc.
- Không được chạm vào chổi lăn khi máy hút bụi đang bật và chổi lăn đang xoay.
- Đề ý đến các ngón tay nếu vệ sinh bên trong ống hút sàn. Nan kim loại của chức năng BRUSHROLLCLEAN® rất sắc và có thể gây thương tích.









Sử dụng máy hút bụi trong các trường hợp trên có thể gây thương tích nghiêm trọng hoặc làm hỏng máy hút bụi. Thương tích hoặc hư hỏng do không tuân thủ các khuyến cáo này sẽ không thuộc phạm vi bảo hành của Electrolux.

BẢO DƯỠNG VÀ BẢO HÀNH

Mọi công việc bảo dưỡng hoặc sửa chữa thiết bị phải do trung tâm dịch vụ được ủy quyền của Electrolux thực hiện.

Bảo hành không bao gồm tuổi thọ pin giảm do lão hóa hoặc quá trình sử dụng, do tuổi thọ pin phụ thuộc vào thời gian và số lần sử dụng máy hút bụi.

ĐÈN BÁO

ĐANG SẠC 	ĐIỀU ĐÓ CÓ Ý NGHĨA GÌ?	ĐANG SỬ DỤNG	ĐIỀU ĐÓ CÓ Ý NGHĨA GÌ?
	Nhấp nháy chậm = sạc đầy 100 %		75 - 100 % dung lượng pin
	Đã sạc 50 - 95 %		Còn 50- 75 % dung lượng pin
	Đã sạc 0 - 50 %		Còn 25- 50 % dung lượng pin
			ERGORAPIDO® cần sạc lại.

Để bảo vệ động cơ, không nên cất giữ hoặc sử dụng pin và các bộ phận điện tử trong điều kiện:

- Nhiệt độ môi trường dưới 5°C hoặc trên 35°C. Nếu cất giữ thiết bị ở nhiệt độ dưới 5°C hoặc trên 35°C, hãy để thiết bị mát hoặc ẩm lên và khô trong vài giờ trước khi sử dụng.
- Độ ẩm dưới 20% hoặc trên 80% (không ngưng tụ).

Nếu cất giữ thiết bị trong thời gian dài (không sử dụng hoặc sạc liên tục), chúng tôi khuyến cáo nên bảo quản thiết bị ở nhiệt độ phòng khi pin được sạc ít nhất 50% dung lượng. Cách này sẽ duy trì hiệu quả sử dụng thiết bị.

Lưu ý! Có thể xảy ra hiện tượng đóng sương bên trong sản phẩm nếu di chuyển sản phẩm từ nơi lạnh đến nơi ấm hoặc sau khi sưởi trong phòng bảo quản. Chờ sau vài giờ để các bộ phận bên trong ấm lên và khô trước khi sử dụng.

TRUY CẬP TRANG WEB CỦA CHÚNG TÔI ĐỂ:



Xem lời khuyên về cách sử dụng, tài liệu giới thiệu, khắc phục sự cố và thông tin dịch vụ:
www.electrolux.com



Đăng ký sản phẩm để nhận dịch vụ tốt hơn:
www.electrolux.com/productregistration



Mua phụ kiện và vật tư tiêu hao cho thiết bị của bạn:
www.electrolux.com/shop

CHĂM SÓC KHÁCH HÀNG VÀ DỊCH VỤ

Khi liên hệ với trung tâm dịch vụ Electrolux, hãy đảm bảo rằng bạn chuẩn bị sẵn các dữ liệu sau:

- Số model,
- Số PNC
- Số sêri

Có thể tìm thấy thông tin trên nhãn thiết bị.

Số model

Số PNC

Số sêri

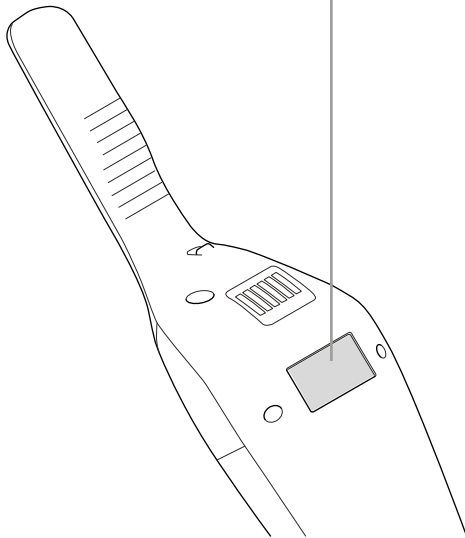
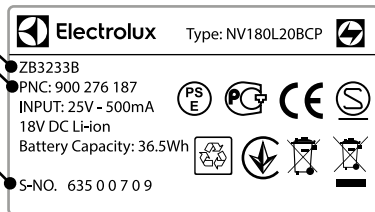

VẬT TƯ TIÊU HAO & PHỤ KIỆN



www.electrolux.com/shop

Bộ lọc
Mã tham chiếu: EF150
PNC: 900 168 3748



Bộ phụ kiện xe hơi
Mã tham chiếu: KIT10A
PNC: 900 167 1677

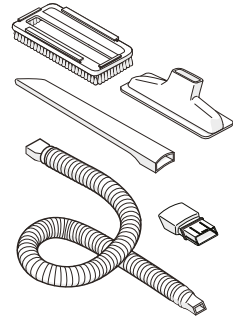

BedPro™ MINI
Mã tham chiếu: ZE125
PNC: 900 168 0819

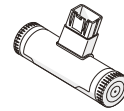

THỜI GIAN VẬN HÀNH ERGORAPIDO®

Thời gian hoạt động thực tế có thể thay đổi do cách thức và môi trường sử dụng

Vôn	Chế độ công suất lớn	Chế độ thời gian hoạt động lâu
14,4V	16 ph khoảng chừng	42 ph khoảng chừng
18V	16 ph khoảng chừng	48 ph khoảng chừng

Bảo hành không bao gồm tuổi thọ pin giảm do lão hóa hoặc quá trình sử dụng, do tuổi thọ pin phụ thuộc vào thời gian và số lần sử dụng máy hút bụi.



Biểu tượng này trên sản phẩm cho biết sản phẩm có chứa pin sạc tích hợp, không được tiêu hủy pin này chung với rác thải sinh hoạt thông thường.



Biểu tượng này trên sản phẩm hoặc bao bì sản phẩm cho biết rằng không được xử lý sản phẩm này như rác thải gia đình.

Để tái chế sản phẩm, vui lòng đưa sản phẩm đến điểm thu gom chính thức hoặc trung tâm dịch vụ của Electrolux, nơi có thể tháo và tái chế pin và các bộ phận điện tử một cách an toàn và chuyên nghiệp. Tuân thủ theo các quy định tại quốc gia của bạn về thu gom riêng các sản phẩm điện và pin sạc.

GB

CS

CT

ID

KO

TH

VI

中国

伊莱克斯 (中国) 电器有限公司 上海小家电分公司
中国, 上海, 静安区共和新路1968号大宁国际广场
8号楼606室
办公电话: +86 21 3178 1000
传真: +86 21 3387 0368
售后服: +86 9501 5801
服务邮箱: saservice.china@electrolux.com
网站: www.electrolux.com.cn

台湾

新加坡商伊莱克斯股份有限公司 台湾分公司
22065新北市板橋區縣民大道2段68號9F
免付費客服專線: 0800-888-259
傳真: 886-2-8964-5269
電郵: service@electrolux.com.tw
網站: www.electrolux.com.tw

KOREA

Electrolux Korea limited
9F, Pine Avenue B,
100 Euljiro, Jung-gu, Seoul, Korea 04551
Tel : +(82) 2 6020-2200
Fax: +(82) 2 6020-2271-3
Customer Care Services : +(82) 1566-1238
Email : homecare.kr@electrolux.com
Website: www.electrolux.co.kr

INDONESIA

Electrolux Building 2nd Floor
Jl. Abdul Muis No 34,
Jakarta Pusat 10160
Indonesia
Tel: +(62) 21 5081 7303
Fax: +(62) 21 5081 8069
Customer Care Services: +(62) 0804 111 9999
Email: customercare@electrolux.co.id
Website: www.electrolux.co.id
DEPDAG: 1.31.E112.01301.1016

PHILIPPINES

Electrolux Philippines Inc.
10th Floor. W5th Avenue Building
5th Avenue Corner 32nd Street
Bonifacio Global City,
Taguig Philippines 1634
Tel: +(63) 2 737 4757
Domestic Toll Free : 1 800 10 845 care 2273
Customer Care Services: +(63) 2 845 care 2273
Email: wecare@electrolux.com
Website: www.electrolux.com.ph

THAILAND

Electrolux Thailand Co Ltd
Electrolux Building
14th Floor 1910 New Petchburi Road
Bangkapi, Huay Kwang
Bangkok 10310
Thailand
Tel: +(66) 2 725 9100
Fax: +(66) 2 725 9299
Customer Care Services: +(66) 2 725 9000
Email: customercarethai@electrolux.com
Website: www.electrolux.co.th

VIETNAM

Electrolux Vietnam Ltd
Floor 9th, A&B Tower
76 Le Lai Street
Ben Thanh Ward - District 1
Ho Chi Minh City
Vietnam
Tel: +(84) 8 3910 5465
Fax: +(84) 8 3910 5470
Customer Care Services: 1800-58-8899
Email: vncare@electrolux.com
Website: www.electrolux.vn

MALAYSIA

Electrolux Home Appliances Sdn Bhd
Lot C6, No. 28, Jalan 15/22,
Taman Perindustrian Tiong Nam,
40200 Shah Alam, Selangor
Malaysia
Customer Care Hotline: 1300-88-11-22
Customer Care Services Tel: (+60 3) 5525 0800
Customer Care Services Fax: (+60 3) 5524 2521
Email: malaysia.customercare@electrolux.com
Website: www.electrolux.com.my

SINGAPORE

Electrolux SEA Pte Ltd
1 Fusionopolis Place, Galaxis #07-10 (West Lobby)
Singapore 138522
Fax: +(65) 6727 3611
Customer Care Services: +(65) 6727 3699
Email: customer-care.sin@electrolux.com
Website: www.electrolux.com.sg

HONG KONG PRC

大昌貿易行有限公司
電器維修中心
香港九龍灣啟祥道20號
大昌行集團大廈5樓
服務熱線: +(852) 3193 9888
電子郵件: dthead@ead.dch.com.hk
網頁: www.electrolux.com.hk

AUSTRALIA

Electrolux Home Care & Small Domestic Appliances
ABN 51 004 762 341
163 O'Riordan Street, Mascot, NSW 2020, Australia
Customer Service Phone: 1300 365 305
Website: www.electrolux.com

NEW ZEALAND

Electrolux Home Care & Small Domestic Appliances
A division of Electrolux (NZ) Limited
3-5 Niall Burgess Road, Mt. Wellington, Auckland,
New Zealand
Phone: (09) 573 2220
Customer Service Phone: 0508 730 730
Website: www.electrolux.com

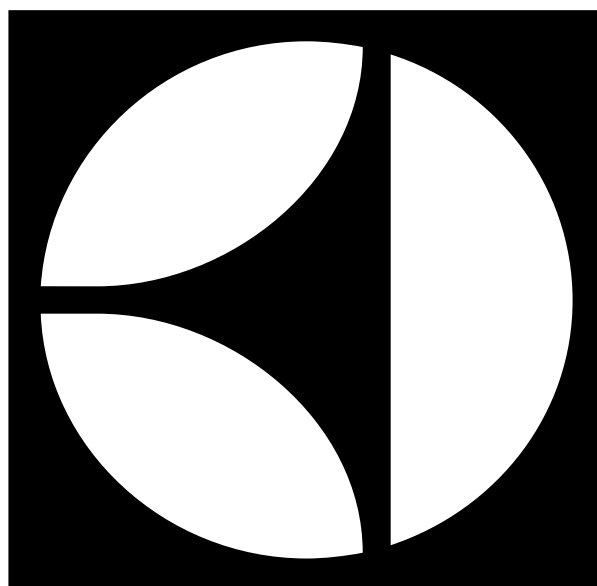

[electrolux.com/shop](https://www.electrolux.com/shop)



Electrolux Appliances AB
S:t Göransgatan 143
S-105 45 Stockholm
Sweden

www.electrolux.com